

# Starrett®



DIGITAL VIDEO COMPARATORS

HDV300

HE400

HB400

HD400

HF600

HF750

VB400

VF600

METROLOGY  SOLUTIONS

# STARRETT OPTICAL COMPARATORS

RUGGED, ACCURATE & EASY TO USE

Starrett's new HDV horizontal digital video comparators combine the best features of a horizontal optical comparator and a vision metrology system. With a rigid steel design, they are configured like a traditional horizontal comparator. The workstage is the same as the Starrett field-proven HB400 and HD400 comparators, with a 110lb (50kg) load capacity. The heart of the system centers on a uniquely mounted 5-megapixel digital video camera and are available with a choice of seven telecentric lenses for micron-level resolution and optical distortion as low as 0.001% for accurate field-of-view (FOV) measurements. Lenses provide a maximum field of view of up to 62mm x 47mm. Stage movement can be related to the imported file allowing part comparison up to 400mm" long.

The HDV systems house a powerful 64-bit PC, which runs MetLogix M3 Metrology software. With this software, DXF CAD files can be imported and 2D Go-No-Go gauges can be developed directly from the CAD files. Video edge detection (VED), allows real-time interaction of the imported file with the video image of the part being inspected. Productivity, speed and accuracy are all enhanced.



**Starrett®**

HDV300  
HDV400



## HORIZONTAL DIGITAL VIDEO PROJECTOR

The HDV Series consists of two models with stage sizes 300mmx150mm or 400mmx150mm of X-Y stage travel. They feature a 5-megapixel video camera and a choice of seven interchangeable telecentric lenses (patent pending) for ultra-low optical distortion field-of-view (FOV) measurements.

Using MetLogix M3 software, DXF CAD files can be imported for direct comparison to the part video image. The HDV series can also perform as a manual horizontal vision system for part measurement utilizing a 6.5:1 zoom lens delivering higher magnifications for increased accuracy.

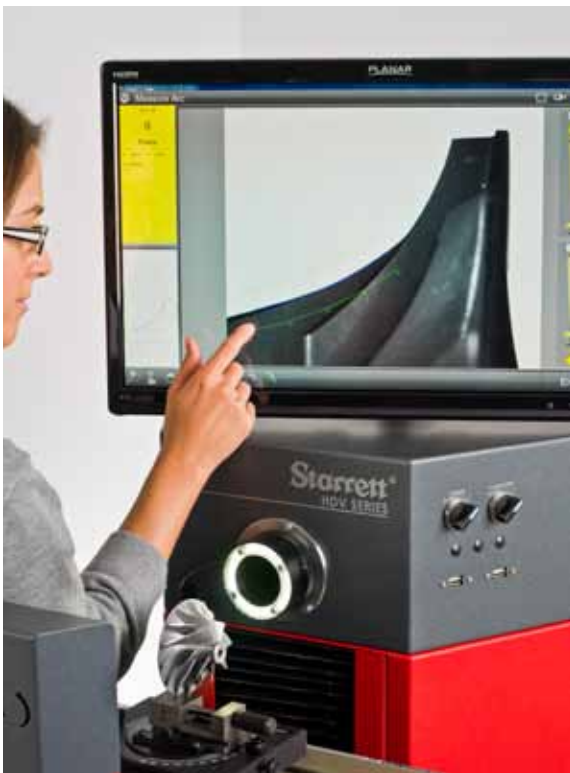

### FEATURES

- Steel construction with hard anodized X Y stage.
- 300mm x 150mm (12"x6") of stage travel for HDV300
- 400mm x 150mm (16"x6") of stage travel for HDV400
- 540mm x 130mm (21.3"x5.1") workstage
- 110lb (50kg) maximum load capacity
- 51mm (2"mm) of focus travel
- Helix angle adjustment with  $\pm 15^\circ$  Vernier scale
- Manual X-Y and focus positioning via hand wheels
- Heidenhain glass scales for 0.5 $\mu$ m (0.00002") X and Y resolution
- LED illumination for surface and profile lighting
- 5 megapixel black & white camera (2448x2058 pixels)
- Ultra-low distortion to 0.001% for telecentric field-of-view measurements
- 64-bit Intel® Processor
- Windows® 7 Professional operating system
- MetLogix M3 software with DXF/FOV option pack
- Parts displayed on 24" (60 cm) touch-screen color monitor (1920x1080 pixels)

### OPTIONS

- Choice of 7 telecentric lenses for fields of view from 2.36"x1.77" to 0.09"x0.07"
- 6.5:1 zoom optics
- 23" or 32" high cabinet stands

**METLOGIX M3** DXF/FOV software under Windows 7 Professional is the power-house behind the HDV Series. Fully integrated with an M3 controller and a powerful 64-bit computer, which runs the Metlogix software. The main operator interface is a 24" (60cm)

touch-screen color monitor. A keyboard is also provided, for ease of data entry and control when desired. All electronics are located in the housing for an integrated design with minimal external wiring.

FEATURE	METLOGIX M3
PC installed in main housing	•
Color graphic touch-screen	•
Windows® 7 operating system	•
X-Y-Q (angle) measurements	•
2D geometry software with skew	•
Video edge detection	•
CAD file import & export	•
FOV measurements	•
Elimination of overlays	•
Software developer	MetLogix

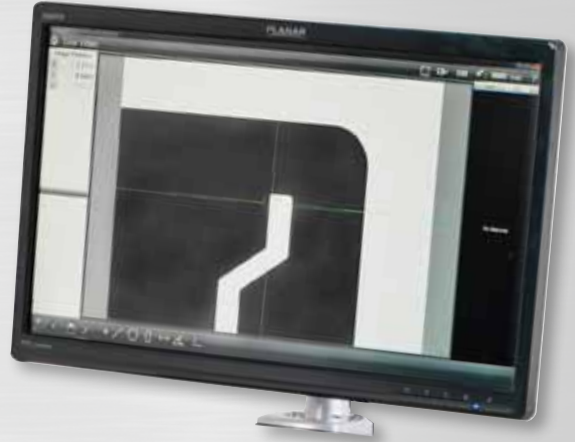

## HDV OPTICS

The HDV Series is available with a choice of seven telecentric lenses and a 6.5:1 zoom lens. Lenses are installed by a bayonet fitting, which allows quick changeover between magnifications and between

FOV or zoom operation by the user. The 0.14X lens has a dedicated mounting configuration and illuminators.

SYSTEM PARAMETER	TELECENTRIC LENSES							6.5:1 ZOOM LENS	
	0.14X	0.30X	0.50X	0.80X	1.0X	2.0X	4.0X	0.7X	4.5X
Optical Magnification	0.14X	0.30X	0.50X	0.80X	1.0X	2.0X	4.0X	0.7X	4.5X
Magnification on 24" Monitor	8.6X	18.5X	21X	49X	62X	124X	247X	58X	363X
Field of View Width	2.36" (63mm)	1.14" (29mm)	.59" (15mm)	.43" (11mm)	.35" (9mm)	.18" (4.3mm)	.09" (2.3mm)	.4" (11mm)	.05" (1.5mm)
Working Distance	4.3" (110mm)							3.4" (88mm)	
Optical Distortion, %	0.001	0.001	0.002	0.002	0.005	0.005	0.006	N/A	N/A

## HDV300 DIMENSIONS

Shipping weight: 300 lb (136 kg)





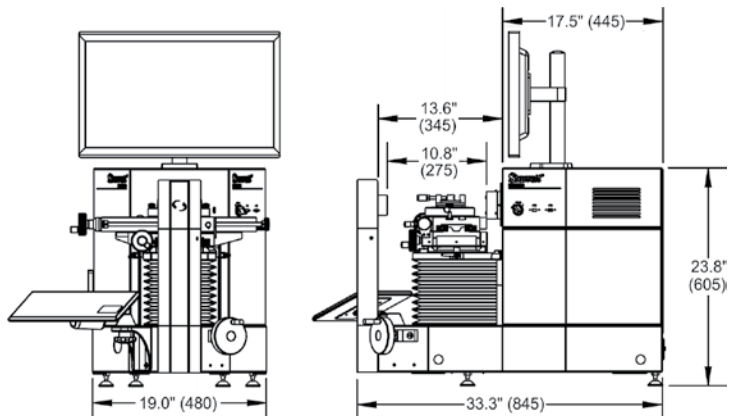

Net weight: 220 lb (100 kg)

Shipping dimensions:  
54"x40"x46" (137x102x117cm)



## ACCESSORIES

Starrett manufactures a comprehensive range of fixtures and accessories for our line of optical comparators and vision metrology systems.

ACCESSORIES		
Precision Centers and Vees	Rotary Vee Blocks	Cabinet Stands
		
Vertical Glass Plate Holders	Fixed Vises	
		
Rotary Vises	Interchangeable Lenses	
		

Willrich Precision  
Ph 866-945-5742  
sales@willrich.com

