

MarShaft

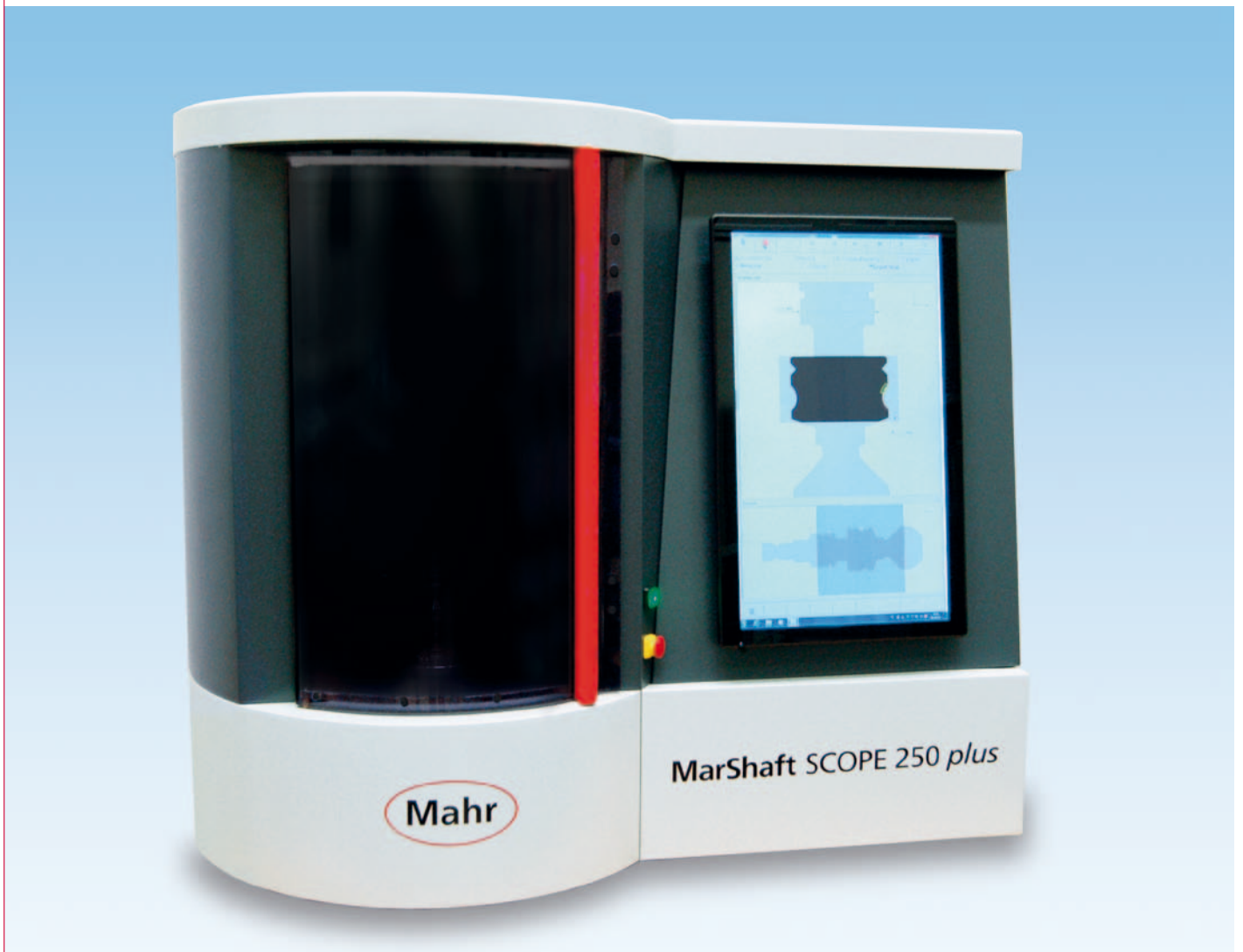

MarShaft SCOPE 250 *plus*

Willrich Precision
Ph 866-945-5742
email: sales@willrich.com

—
- 0 +

Mahr

E X A C T L Y

- ▶ | Flexible shaft measuring machine for measuring small, rotationally symmetrical workpieces such as turned parts
 - Use in production
 - Fast and easy operation
 - Maximum measuring accuracy in harsh manufacturing environments
 - New matrix camera with 40mm x 24mm image field

MarShaft SCOPE 250 *plus*

Mahr offers measuring systems for factories of the future



The role of dimensional metrology is expanding at a dramatic rate, in parallel with innovations in manufacturing processes. Given the ever more stringent accuracy requirements and falling cycle times in production (turning, milling, grinding, etc.), rapid measurement directly at the manufacturing machine is absolutely essential. So, measurement at the point of origin of the product, with rapid feedback to the manufacturing process to avoid waste is the problem you need to get solved. Mahr's flexible MarShaft SCOPE 250 *plus* shaft measuring machine offers the right measuring solution for the fast, precise and fully automatic measurement of rotationally symmetrical workpieces in production.

The MarShaft SCOPE 250 *plus* has a high precision roundness measuring axis (C) and a vertical measuring axis (Z) with a measuring range of 250 mm. The jewel in the crown is the state-of-the-art, high resolution CMOS matrix camera (providing the live image) with an image field of 40 mm x 24 mm. The extremely high image acquisition rate of over 120 images per second keeps measuring times to a minimum. Zoom functions allow the smallest details to be measured, which are difficult, and in some cases even impossible, to test with conventional measuring methods.

MarShaft SCOPE 250 plus

The main measurable features

- Length
- Diameter
- Form and position tolerances
- Offsets
- Recess width
- Bevel width
- Intersection points
- Position of intersection points
- Angles of rotation
- Radii
- Position of radii
- Taper lengths
- Hole contours
- Angles
- Pitches
- Widths across flats
- Outer threads

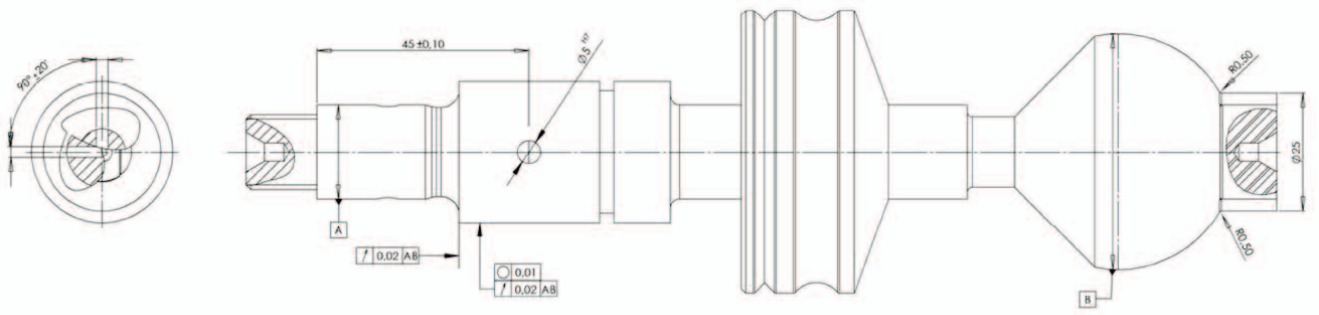
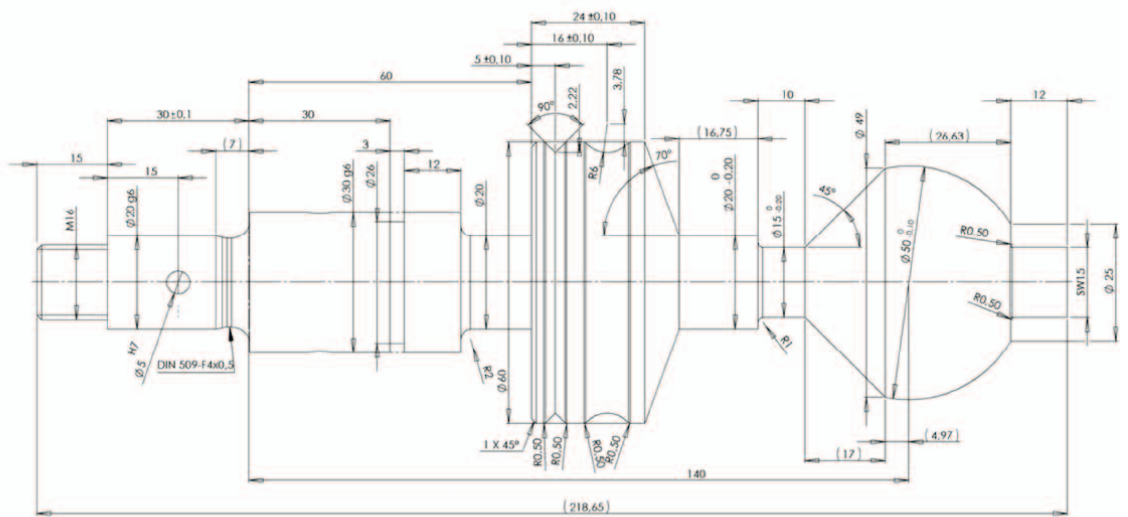

MarShaft SCOPE 250 *plus* / Versions



MarShaft SCOPE 250 *plus* with C-axis and tailstock **Order no. 5361802**

Model with C-axis and tailstock for the static and dynamic measuring of workpieces clamped between centers. 2 centering tips with a cone of 60° for centering bore diameters of 2 mm to 15 mm (order no. 5361112) are included in package.

MarShaft SCOPE 250 *plus* with high-precision C-axis and tailstock **Order no. 5361803**

Model with high-precision C-axis and tailstock for the static and dynamic measuring of workpieces clamped between centers. 2 centering tips with a cone of 60° for centering bore diameters of 2 mm to 15 mm (order no. 5361112) are included in package.



Performance features at a glance:

- New, high-resolution CMOS matrix camera with a large 40 mm x 24 mm live image field allows fast scanning with over 120 images per second
- High precision when measuring diameters and lengths
- Extremely fast measuring times thanks to high measuring speeds of up to 200 mm/s
- By using Mahr's MarWin software platform, you can benefit from our decades of experience in length, shape, position and contour measurement
- Excellent entry level price into the small optical shaft measuring machine segment

MarShaft SCOPE 250 *plus* / Components and accessories

Precision measuring spindle (C-axis) with table plate

High-precision measuring spindle (C-axis) for dynamic measurements such as roundness, radial runout, coaxiality, cylindricity or diameter. The C-axis features the Mahr standard table plate and holds centering tips and other clamps that can be used for many types of workpiece.

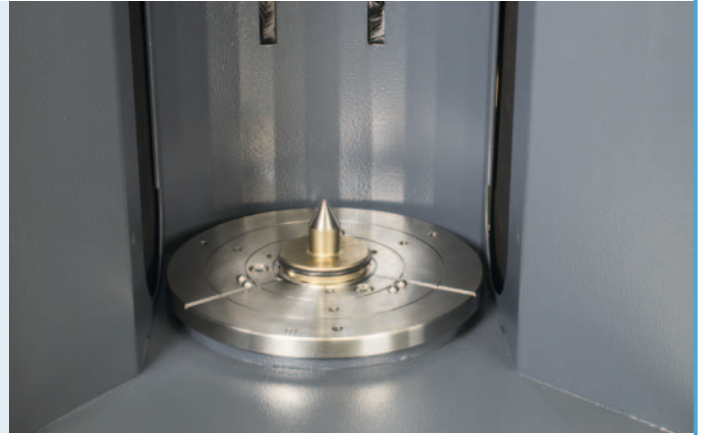

Tailstock

The tailstock serves as the top workpiece holder bearing. The tailstock is equipped with an eccentric clamping mechanism for clamping at any Z-height. This mechanism is tightened and loosened by a clamping lever. The spindle is spring-loaded and automatically exercises the clamping force. Operating the tailstock with one hand allows you to change testpieces safely and easily. For dynamic (i. e. rotational) measurements, the spindle is situated in a high-precision ball bearing.

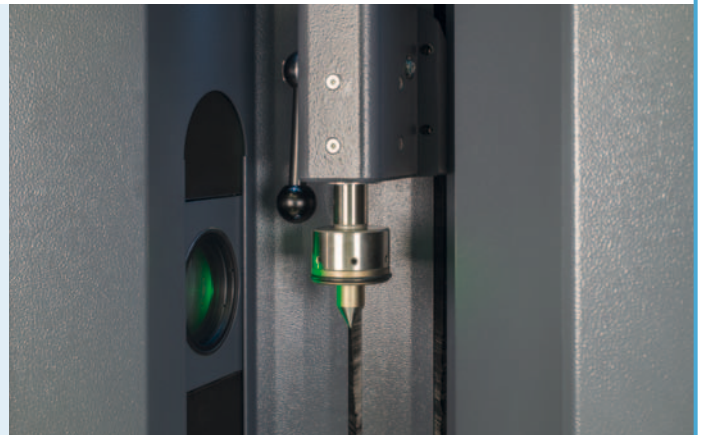

Centering tip with 60° cone for bore Ø 2 mm to 15 mm

Interchangeable standard tip for clamping various workpieces between centers.

2 centering tips with a cone of 60° for centering bore diameter of 2 mm to 15 mm are included in the MarShaft SCOPE 250 *plus* with tailstock package.

Order no. 5361112

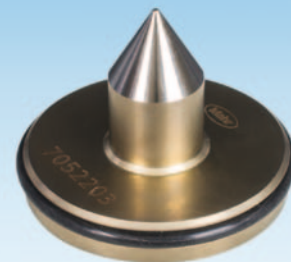

Rim chuck with three jaws and Ø 70 mm with adaptor for the MarShaft SCOPE 250 *plus*

Outer clamping range 1 mm to 70 mm

Included in MarShaft SCOPE 250 *plus* basic package.

Order no. 5361080

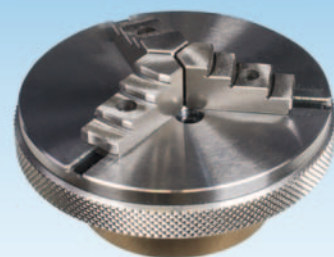

MarShaft SCOPE 250 plus / MarWin EasyShaft

MarShaft SCOPE 250 *plus* / MarWin EasyShaft Software V. 8.0

MarWin EasyShaft software is the measuring, control and evaluation program for the MarShaft SCOPE *plus* series. It enables the precision measurement of diameters, lengths, contour features and form and position tolerances in accordance with standards, and offers many new evaluation and documentation options, all with a well-laid-out, intuitive user interface. The software runs entirely under the familiar Windows® operating system. The user interface is compatible with other Windows® applications, reducing the familiarization time substantially. All Windows®-compatible printers can be used for record output.

Performance features at a glance:

- The familiar Windows® user interface makes for a short learning curve
- The EasyShaft user interface is in line with the standard user interface across all Mahr products (cf. EasyForm or Contour 1)
- Clear, windows-based layout
- User-friendly, 100% touchscreen functionality
- Predefined macros for easy programming (e.g. diameter measurement at the touch of a single button)
- Many functions can be selected directly via obvious icons
- Touchscreen-controllable machine axes
- The live image from the matrix camera is continuously displayed during measurement, i.e. direct visual assessment of the workpiece surface (e.g. soiling) even during measurement
- For individual and series measurements: the ideal operating strategy for every task
- User-friendly, state-of-the-art measuring program management
- Time-optimized measuring program sequence, thus minimal measuring times
- Clear measuring records – in black-and-white or color – output to all Windows® printers
- Future-proof investment, runs under Windows® 7 Ultimate
- Optional data export to statistics programs extends the range of functions of the EasyShaft software

EasyShaft program window

The EasyShaft software gives you full control of the MarShaft SCOPE 250 *plus*. The touchscreen gives you direct access to positioning, programming, measurement and documentation. The clear, simple user interface helps you keep track of everything you need to know. Many functions, e.g. loading measuring results or adding feature measurements, can be activated simply by clicking on obvious icons.

EasyShaft commands

The command bar contains a summary overview of all of the commands required for measuring and evaluating features:

- Macros (composed sequences of evaluation actions, e.g. diameter, radius, distance or angle)
- Features which can be calculated (e.g. direct distance, distance in X and Z, angle, angle sector, radius, roundness, straightness, radial run-out, axial run-out, cylindricity, symmetry etc.)
- Substitute elements which can be calculated (e.g. point, line, circle, point on straight line, intersection point, symmetry straight line, parallel straight line, extreme point, C-reference etc.).

Display palette (touchscreen control of machine axes)

- Used to show or hide the display palette
- Used to select the zoom range
- May be joystick for the C-axis depending on device version
- May be joystick for the Z-axis depending on device version
- Zoom in or out incrementally
- Zoom in or out continuously

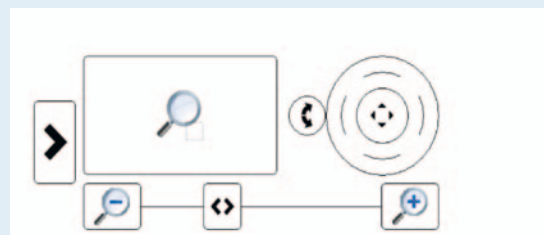

MarShaft Scope *plus* / Marwin Software EasyShaft V. 8.0

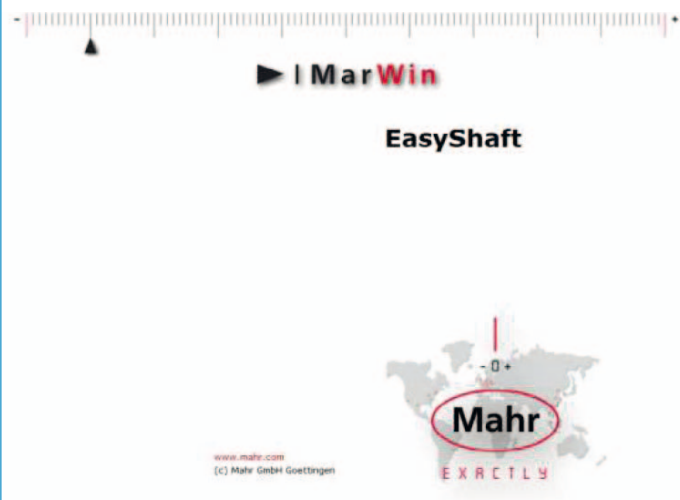

MarWin EasyShaft Software V8.0

MarWin EasyShaft Software V8.0

Order no. 5361580

The MarWin EasyShaft software is the measuring, control and evaluation program for the MarShaft SCOPE *plus* series. It enables the precision measurement of diameters, lengths, contour features and form and position tolerances in accordance with standards, and offers many new evaluation and documentation options, all with a well-laid-out, intuitive user interface.

Country package with Windows 7[®] Ultimate operating system, with optional language versions

- German
- English/International
- French
- Other languages on request

Included in the scope of delivery of the machine version

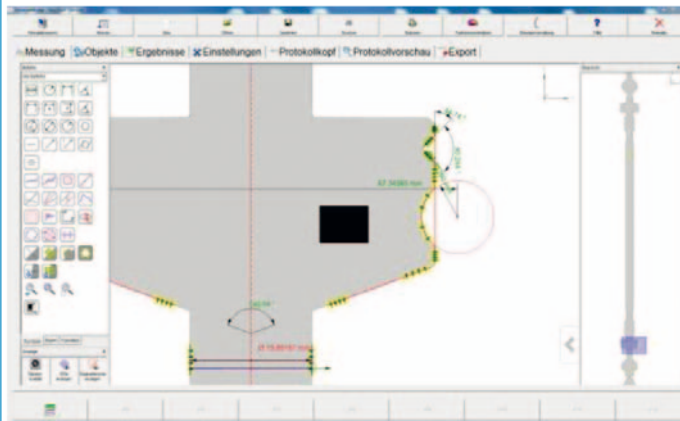

MarWin EasyShaft Offline Programming Software Option

Offline programming option for EasyShaft V8.0

Order no. 536158

Creating measuring programs in offline mode. The testpiece contours can either be created by a fully automatic form scan with a MarShaft SCOPE 250 *plus* or loaded from a STEP file (from a CAD system).

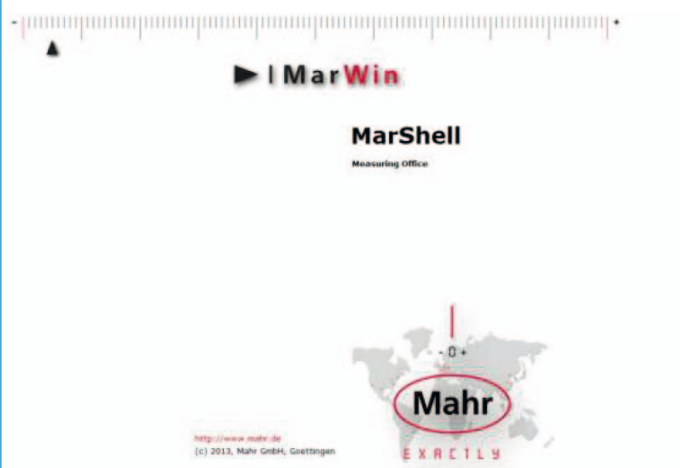

MarWin ProfessionalShaft Software

ProfessionalShaft V8.0 software option

Order no. 5361581

Free programming with MarWin MarScript for implementing customer-specific applications such as measuring symmetry in keyways.

MarShaft SCOPE 250 plus

Technical Data

Dimensions (basic unit) W/H/D	1054 mm x 952 mm x 592 mm
Equipment table height for optimal operation	800 mm x 900 mm
Weight	approx. 120 kg
Measuring range (Z)	250 mm
Workpiece weight	max. 5 kg
Workpiece dimensions	
Max. length in centers	250 mm
Max. length in chuck	150 mm
Max. measurable diameter	40 mm
Max. swivel diameter in centers	100 mm
Max. swivel diameter in chuck	50 mm
Measurement resolution	
Lengths/diameters	adjustable 0.01 mm ... 0.0001 mm 0.001 inch ... 0.0001 inch
Angle	0.01 ... 0.0001 degrees (decimal) or degrees, minutes, seconds
Repeatability 4 σ for 50 measurements	
Length	2.0 μm
Diameter	(0.4 + D/80) μm ; D in mm for clean, ground workpiece surfaces
Error limit MPE_{E1}	
Length	$\leq (3.0 + l/125) \mu\text{m}$; l in mm
Diameter	$\leq (1.5 + l/40) \mu\text{m}$; l in mm valid in temperature range 20°C \pm 2 K
Drives	
Travel speed Z	max. 200 mm/s
Rotational speed C	max. 1.0 1/s
Optics	
Telecentric precision lens; lighting with high light output in flash mode	
Camera	
CMOS matrix camera with USB 3.0 interface	40 mm x 24 mm
Full frame mode	120 images/s
Subframe mode (16 rows)	approx. 1000 images/s
Filter algorithm to exclude dirt particles during the edge calculation.	

MarShaft SCOPE 250 plus

Technical Data

Measuring computer	SFF-PC; WIN 7 x 64; Intel CPU; DVD-RW
Ambient conditions	
Operating temperature	+10 °C ... +35 °C
Recommended working temperature	+15 °C ... +35 °C
Storing/transport temperature	-10 °C ... +50 °C
Permitted humidity	max. 90%; non-condensing!
Temporal temperature gradient	< 2 K/h
Spatial temperature gradient	< 1 K/m ceiling height
Air pressure	1000 hPa ± 200 hPa
Perm. ambient sound pressure	< 75 dB(A)
Electrical connection	
Supply voltage U~	100 V ... 240 V +10 %/-15 %
Mains frequency	50 / 60 Hz
Power consumption	max. 500 VA
Protection class	I
Protection rating	IP32
Sound level	
Emitted sound level	< 70 dB(A)
Perm. ground vibrations	
Range 0.5 Hz ... 20 Hz	2 mm/s to 50 mm/s linear gradient
Range >20 Hz	50 mm/s
Subject to change without notice.	

- 0 +

Mahr

E X A C T L Y

Willrich Precision
Ph 866-945-5742
sales@willrich.com

Mahr GmbH Göttingen

Carl-Mahr-Str. 1, 37073 Goettingen, Germany
Phone: +49 (0)551-7073-800, Fax: +49 (0)551 7073-888
info@mahr.com, www.mahr.com

© by Mahr GmbH, Göttingen
We reserve the right to modify our products, especially in light of technical improvements and further developments.
All illustrations, numerical values etc. are therefore subject to change.