

Surface Roughness Measuring System SURFTEST SJ-500/SV-2100

Bulletin No. 1959



Willrich Precision
Ph 966-945-5742
sales@willrich.com

Surface roughness testers offer benchtop or portable operation and the choice of data analysis by PC or an easy-to-use dedicated processor

Mitutoyo

Dedicated data processor type

Surftest SJ-500/SV-2100

Improved operability

7.5 Color TFT LCD

The dedicated data processor has a high-visibility 7.5" color TFT LCD. Icon display and touch panel operation provide user-friendly display and easy operation.

Positioning by joystick and manual control knobs on the processor

Easy-to-operate joystick. Fine positioning of stylus required for small-hole measurements can be easily performed using the manual fine-adjustment knobs.

Multiple trace function

A machine can be programmed to take up to three traces, one after the other.

Auto leveling table (optional)

Automatically levels the surface to be tested for easy, strain-free setup.

Various types of analysis

Capable of fine-contour analysis

Supports 43 types of analysis parameters, complying with surface roughness standards such as ISO 1997 and JIS 2001. Also capable of various fine-contour analysis.

* Contour analyses: Area, circle, angle, coordinate difference, step, inclination

High-durability

Ceramic guideway

A ceramic guideway, inherently free from wear and deterioration with age, is employed to maintain the traversing straightness of the drive unit (X-axis) indefinitely. Maintenance-free design, since anti-corrosion treatment is not required for ceramic.

SJ-500

Traverse: 1.97" (50mm)
Compact, high-performance type

SV-2100M4

Traverse: 3.94" (100mm)
Manual column type

SV-2100S4/H4/W4

Traverse: 3.94" (100mm)
Power column type

Dedicated data processor

Advanced processing and easy operation

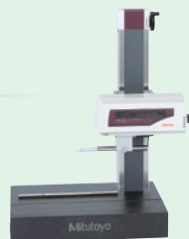

Easy operation, high-accuracy analysis of surface roughness and fine contours!

High-visibility color display panel

A high-visibility 7.5" color TFT LCD, color icon display and touch-operated panel provide user-friendly, easy operation. Built-in thermal printer. Fine contour analysis provided as standard.



Supports 16 languages

Japanese, English, German, French, Italian, Spanish, Portuguese, Korean, Simplified Chinese, Traditional Chinese, Czech, Polish, Hungarian, Turkish, Swedish, Dutch

Multiple trace programming function

A machine can be programmed to take up to three consecutive traces by one-key operation, as shown in the figure below.

•SJ-500/SV-2100M4

Consecutive tracing in X-axis direction only

•SV-2100S4/H4/W4

X-axis tracing with programmed Z-axis shifts possible

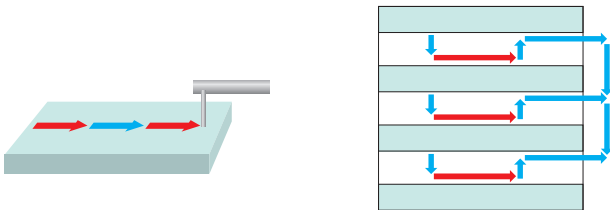

→ Measurement
→ Traverse

Example: SV-2100S4 input screen

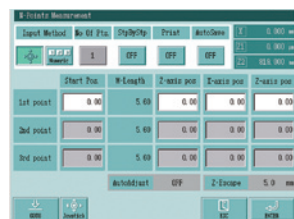

Efficient positioning by joystick and adjustment knobs

Both a fast-traverse joystick (X-axis: $.78"/s$ (20mm/s) for **SJ-500**, $1.98"/s$ (40mm/s) for **SV-2100**, Z2-axis: $.78"/s$ (20mm/s) for **SV-2100S4/H4/W4**) and manual fine-adjustment knobs, essential for positioning in small hole measurement, are standard features.

Positioning in small hole measurement

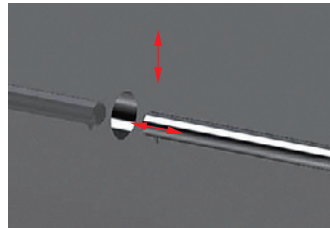

Positioning in Y/Z-directions with column fine-adjustment knob (or detector elevation knob) and optional cross-travel table.



Positioning at the trace start point with X-axis fine-adjustment knob.

Navigation function aids leveling

Powerful support for leveling adjustments

When using an optional 3-axis adjustment table or leveling table, a navigation screen is available to help the operator level the surface to be tested.

Example of 3-axis adjustable table

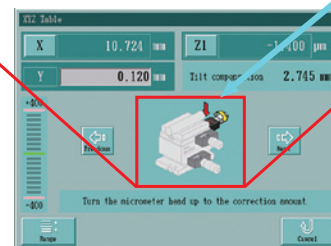
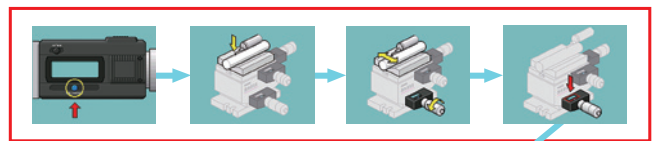

The user is guided through the leveling procedure to determine the amount of adjustment needed.

A portable tester also boasting high performance in desktop applications

Surftest SJ-500

High accuracy, high performance, user-friendly display and easy operation

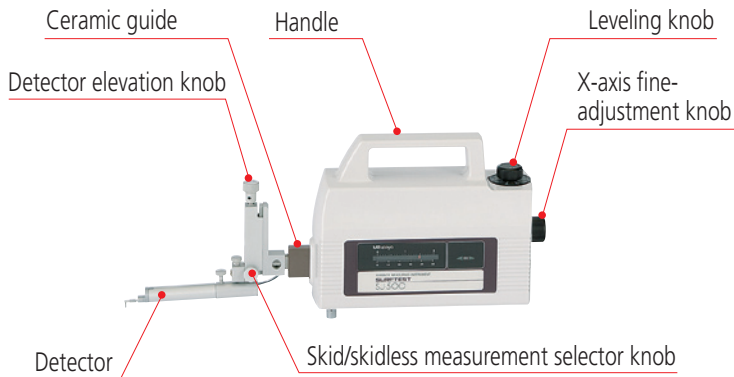

*Class-leading traverse straightness:
8µin/2" (0.2µm/50mm)
High-speed traverse at up to 0.78"/s (20mm/s)
under joystick control
Smooth positioning using the vertical
adjustment knob*

Vertical adjustment knob

Essential for positioning the stylus close to the workpiece!



Support for testing problematic features

Supports measurement in the axial direction for shrouded features, such as found on crankshafts, by simply swiveling the detector through 90 degrees.

Normal tracing

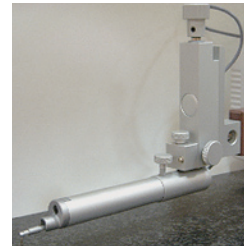

Tracing a shrouded feature

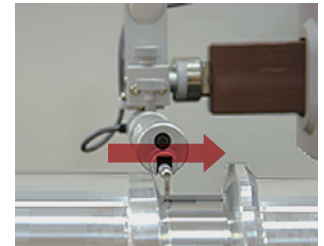

Drive unit inclination adjustment mechanism

Digital Adjustment Tilting (DAT) function is supplied as standard for efficient leveling of workpieces: $\pm 1.5^\circ$
DAT function: Patent pending (Japan, U.S., Germany)

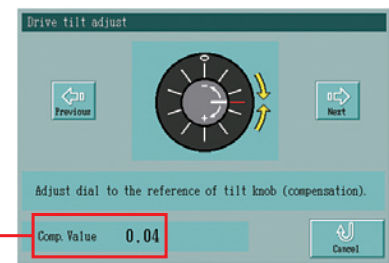

DAT function

Powerful support for manual leveling!!

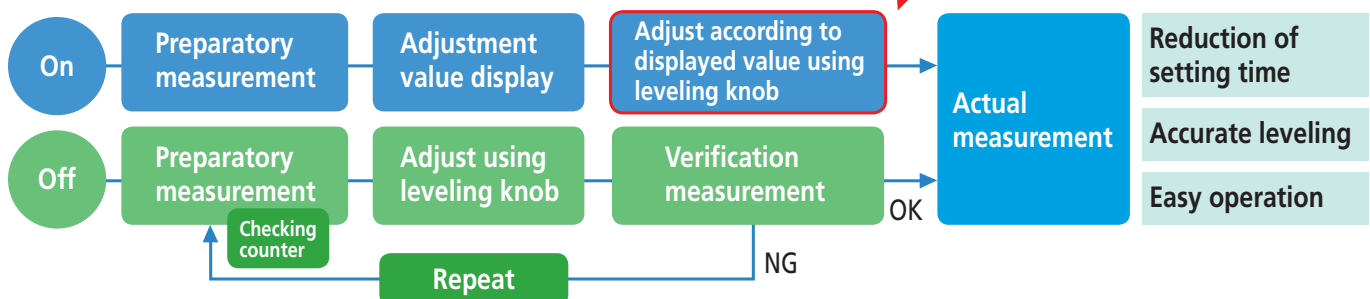

Mitutoyo

A desktop tester that's easy to use for portable applications

Surftest SV-2100

By setting the origin point at start-up, the Absolute scale system allows accurate positioning for repeated or multiple measurements.

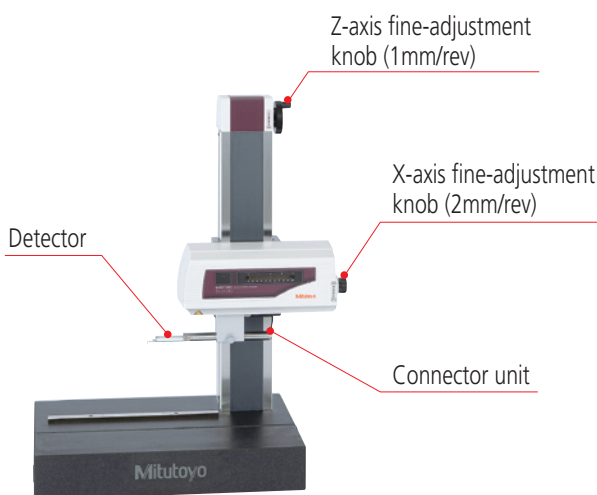

SV-2100M4

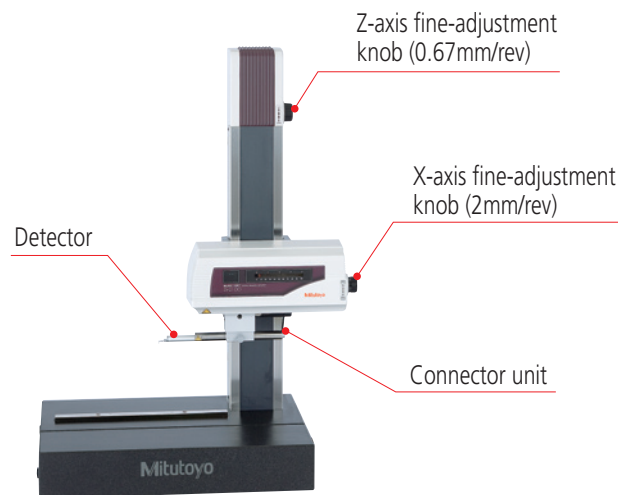

SV-2100S4

High-speed traverse at up to 1.98"/s (40mm/s) (X-axis) under joystick control
Smooth positioning, using the Z-axis fine-adjustment knobs
Stable, high-accuracy measurement with a traverse straightness of 6µin/4" (0.15µm/100mm)

1. Capable of a series of automatic measurements, plus auto leveling (optional) and stylus retraction. Accurate positioning for repeated or multiple measurements possible.

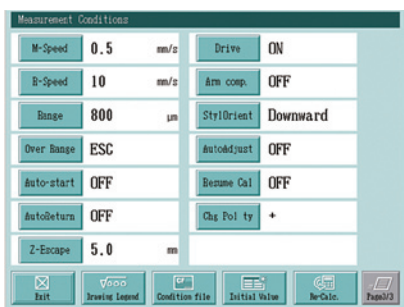

Measurement setup screen

2. **SV-2100S4/H4/W4** models are equipped with an emergency stop button.



3. Base sizes and vertical travel range on column

Model No.	Vertical travel range	Vertical traverse method	Base size
SV-2100S4	13.8" (350mm)	Power and manual	23.6" x 17.72" (600x450mm)
SV-2100H4	21.6" (550mm)		39.4" x 17.72" (1000x450mm)
SV-2100W4			
SV-2100M4	13.8" (350mm)	Manual only	23.6" x 17.72" (600x450mm)

Dedicated data processor

MiCAT

Mitutoyo Intelligent Computer Aided Technology

the standard in world metrology software

FORM

Data processing unit

- Data saving (internal memory)
- High-speed printing
- Expansion slot for external memory (CF card)



- High-visibility 7.5" color LCD

- Touch panel with color icon display

- Display supports 16 languages

- Key panel

- Joystick

Customizable menu screen

The menu customization function allows display of frequently used menu icons

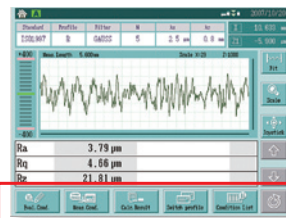

One-touch display of various screens

Home screen



Evaluation setup screen



Measurement setup screen



Calibration screen

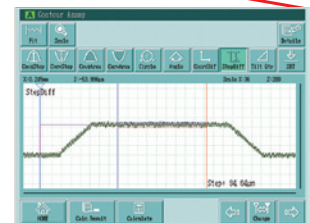

Contour analysis screen

Statistical processing

Statistical data processing possible (up to 300 data samples)
Statistical processing items: MAX, MIN, average, standard deviation, histogram, probability of acceptance.

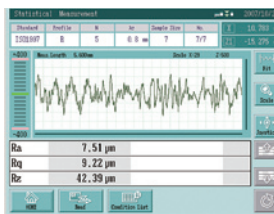

Statistical data input



Statistical results

Saving and recalling measurement setups

Up to 10 measurement setups can be saved to and recalled from internal memory.

One-touch recall of stored setups

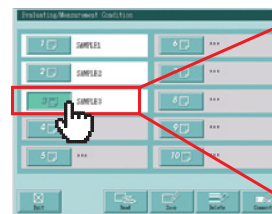

Click the desired measurement setup file



Measurement screen opens

Mitutoyo

Analysis to international standards

Evaluates surface roughness using up to 43 parameters complying with international standards such as ISO 1997 and JIS 2001. Bearing Area Curve (BAC), Amplitude Distribution Curve (ADC), and power spectrum (wavelength display) are readily available in graph form.

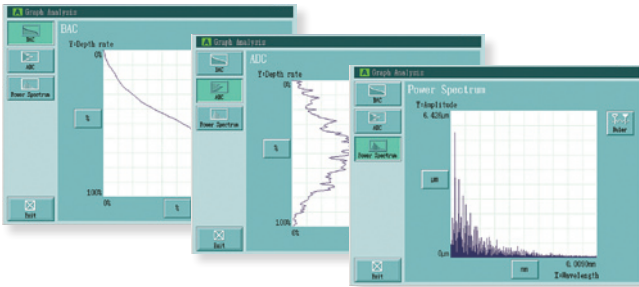

A large variety of optional accessories

Options supporting measurement including an auto leveling table, a 3-axis adjustment table, and a leveling table. Furthermore, these can be easily operated via a navigation function. (Supported accessories differ depending on the model.)



Fine-contour analysis

Various contour analyses (area, circle, angle, coordinate difference, step, inclination) are supplied as standard.

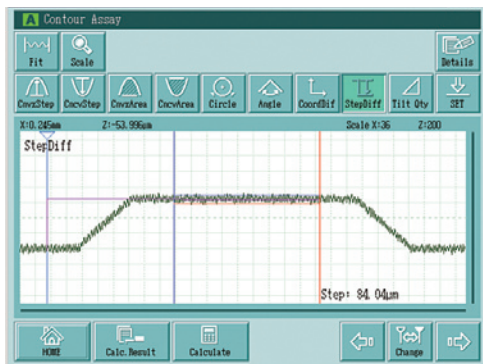

Select desired analysis icon and then specify the range.

Easy, icon-based input of setup conditions

* Patent pending

Setups are aided by icons representing ISO/JIS roughness standard parameters with appropriate values selected from recommended lists.

Typical surface roughness symbol on drawing

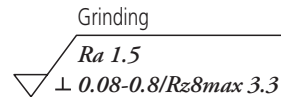

Typical result of icon-based setup

U"X"0.08—0.8/Rz8max 3.3

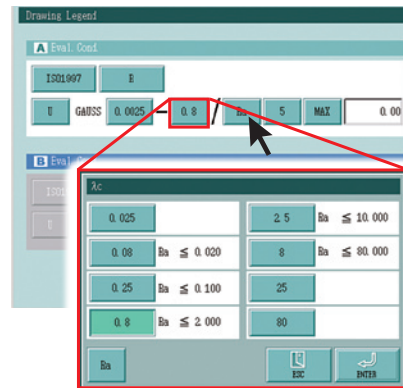

Clicking a parameter icon displays the recommended cut-off value, etc.

Built-in thermal printer

Measurement data is printed by the high-definition, high-speed thermal printer. In addition to calculation results and evaluation results, BAC, ADC and other curves can also be printed.

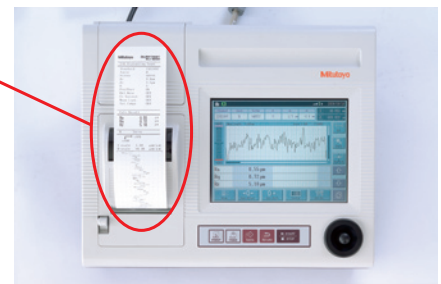
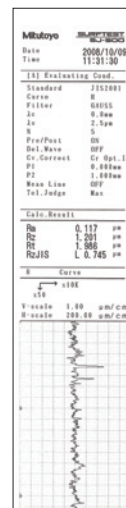

PC data processing type Surftest SJ-500P

A superior data processing tester with PC data analysis for higher efficiency.

* If a power column type with PC data-processing is desired, consider the SV-3100 series



SJ-500P

SURPAK-EZ: Easy-to-use task-focused software

User-friendly graphical display and button layout allows intuitive operation. Simplified fine-contour analysis provided as standard, including step, area, and circle calculation.

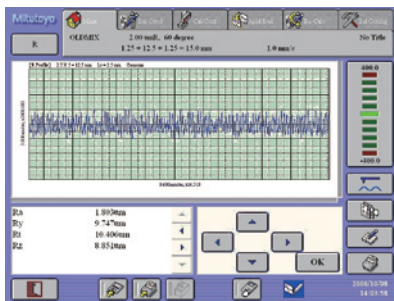

Measurement and results display screen



Calibration and control screen (SJ-500P)

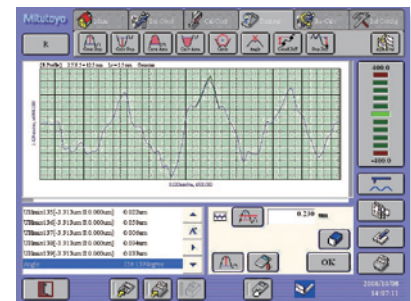

Simplified contour analysis screen

Specifications

Specifications

Type of data processing		Dedicated data processor					PC system
Model No.		SJ-500	SV-2100M4	SV-2100S4	SV-2100H4	SV-2100W4	SJ-500P
Order No.*	with 0.75 mN detector	178-533-01A	178-637-01A	178-681-01A	178-683-01A	178-685-01A	178-531-01A
	with 4 mN detector	178-533-02A	—	—	—	—	—
Travel range (operation)	X axis	2" (50mm) (power drive/manual)	3.94" (100mm) (power drive / manual)				2" (50mm) (power drive / manual)
	Z2 axis (column)	—	350mm (manual)	13.8" (350mm) (power drive / manual)		—	
Measuring range	X axis	2" (50mm)	3.94" (100mm)				2" (50mm)
	Z1 axis (detector unit)	3200µin / 3200µin / 320µin (800µm / 80µm / 8µm)					—
Resolution	X axis	1.97µin (0.05µm)					—
	Z1 axis (detector unit)	0.4µin / 3200µin range, 0.4µin / 3200µin range, 0.004µin / 320µin range (0.01µm / 800µm range, 0.001µm / 80µm range, 0.0001µm / 8µm range)					—
	Z2 axis (column)	—	—	(1µm)		—	
Power drive speed	X axis	0 - 0.78"/s 0 - 20mm/s (via joystick)	0 - 1.98"/s (0 - 40mm/s) (via joystick)				0 - 20mm/s (via PC)
	Z2 axis (column)	—	—	0 - 0.78"/s (0 - 20mm/s) (via joystick)		—	
Measuring speed		0.00078" - 0.2"/s (0.02 - 5mm/s)					—
Traverse guideway straightness		8 µin / 2" (0.2µm / 50mm)	6µin / 4" (0.15µm / 100mm)			8µin / 2" (0.2µm / 50mm)	
Stylus up/down operation		Arc movement					—
Point of stylus		Downward					—
Detector	Measuring force	0.75 mN or 4 mN					—
	Stylus tip	0.75mN detector: 60°, R2 µm or 4mN detector: 90°, R5µm					—
Applicable standards		JIS'82 / JIS'94 / JIS'01 / ISO'97 / ANSI / VDA					—
Assessed profiles		Dedicated data processor type: P (primary profile), R (roughness profile), WC, envelope residual profile, roughness motif, waviness motif PC system type: P (primary profile), R (roughness profile), WC, WCA, WE, WEA, DIN4776 profile, E (envelope residual profile), roughness motif, waviness motif					—
Evaluation parameters		Dedicated data processor type: Ra, Rc, Ry, Rz, Rq, Rt, Rmax, Rp, Rv, R3z, Sm, S, Pc, mr (c), δc, mr, tp, Htp, Lo, lr, Ppi, HSC, Δa, Δq, Ku, Sk, Rpk, Rvk, Rk, Mr1, Mr2, A1, A2, Vo, λa, λq, R, AR, Rx, W, AW, Wx, Wte, (43 parameters), Customization PC system type: Pa, Pq, Psk, Pku, Pp, Pv, Pz, Pt, Pc, PSm, PΔq, Pmr (c), Pmr, Pδc, Ra, Rq, Rsk, Rku, Rp, Rv, Rz, Rt, Rc, RSm, RΔq, Rmr (c), Rmr, Rδc, Wa, Wq, Wsk, Wku, Wp, Wv, Wz, Wt, Wc, WSm, WΔq, Wmr (c), Wmr, Wδc, Rk, Rpk, Rvk, Mr1, Mr2, A1, A2, Rx, AR, R, Wx, AW, W, Wte, Ry, RyDIN, RzDIN, R3y, R3z, S, HSC, Lo, lr, Δa, λa, λq, Vo, Htp, NR, NCRX, CPM, SR, SAR, NW, SW, SAW					
Analysis graphs		Dedicated data processor type: ADC, BAC, power spectrum graph PC system type: ADC, BAC Graph, power spectrum graph, auto-correlation graph, Walsh power spectrum graph, Walsh auto-correlation graph, slope distribution graph, local peak distribution graph, parameter distribution graph					—
Curved surface compensation		Dedicated data processor type: Parabolic compensation, Hyperbolic compensation, Elliptical compensation, Circular compensation Conic compensation, Inclination (Entire, Arbitrary) PC system type: Parabolic compensation, Hyperbolic compensation, Elliptical compensation, Circular compensation, Conic compensation, Inclination (Entire, Arbitrary), Polynomial compensation					—
Contour analysis		Dedicated data processor type: Area, Circle, Angle, Coordinate difference, Step, Inclination PC system type (SURFPAK-EZ): Area, Circle, Angle, Coordinate difference, Step, Inclination					—
Filters		Dedicated data processor type: 2CR-75%, 2CRPC-75%, Gaussian, Robust-spline PC system type: 2CR-75%, 2CR-50%, 2CRPC-75%, 2CRPC-50%, Gaussian, Rubust-spline					—
Base size (width x depth)		—	23.6" x 17.7" (600x450mm)			39.4" x 17.7" (1000x450mm)	—
Base material		Granite					—
External dimensions (W x D x H)	Main unit	16.7"x3.7"x6.3" (425x94x160mm)	28.2"x17.7"x34" (716x450x863mm)	30.16"x17.7"x38" (766x450x966mm)	30.16"x17.7"x45.9" (766x450x1166mm)	45.9"x17.7"x46.3" (1166x450x1176mm)	16.7" x 3.7 x 6.3" (425x94x160mm)
	Display unit	12.9" x 10.63" x 4.38 (330x270x124mm)					—
	Electronic unit	—	—	14.6" x 9.65" x 2.83" (372x245x71.8mm)			—
	PC I/F unit	—	—	—	—	—	13.7" x 10.4" x 3.4" 350x263x86mm
Mass	Main unit	5.9 lbs (2.7kg)	308.6 lbs (140kg)	308.6 lbs (140kg)	330.7 lbs (150kg)	485 lbs (220kg)	5.91 lbs (2.7kg)
	Display unit	8.8 lbs (4.0kg)					—
	Electronic unit	—	—	6.6 lbs (3.0kg)			—

Dimensions

Unit: mm

SJ-500

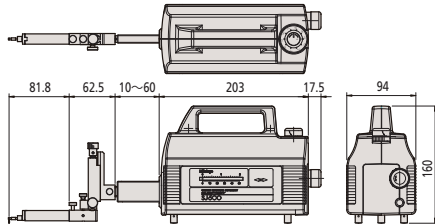

Dedicated data processor

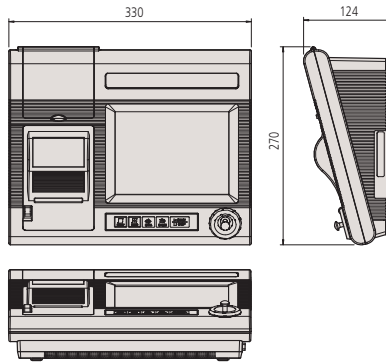

Electronic unit

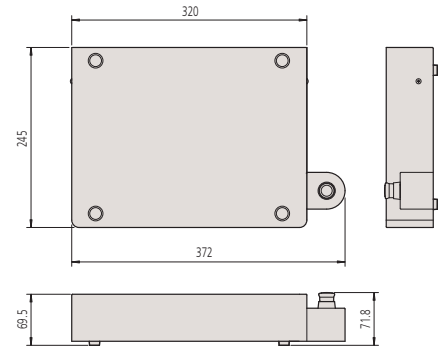

Only for SV-2100S4 / H4 / W4

SV-2100M4

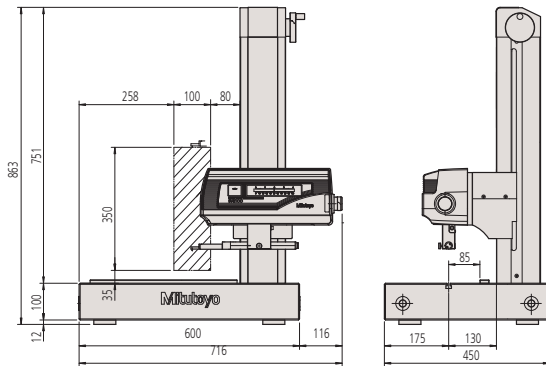

SV-2100S4 / SV-2100H4

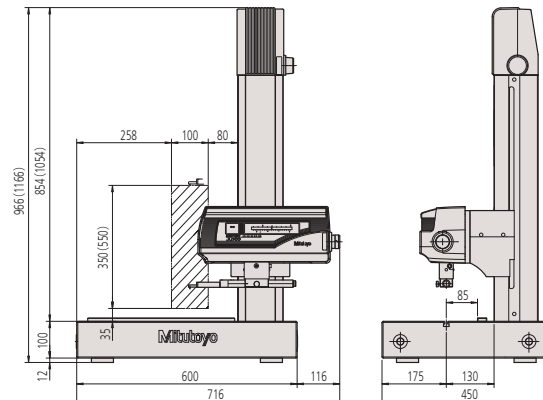

() : SV-2100H4

SV-2100W4

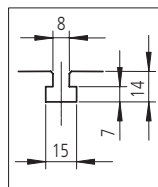
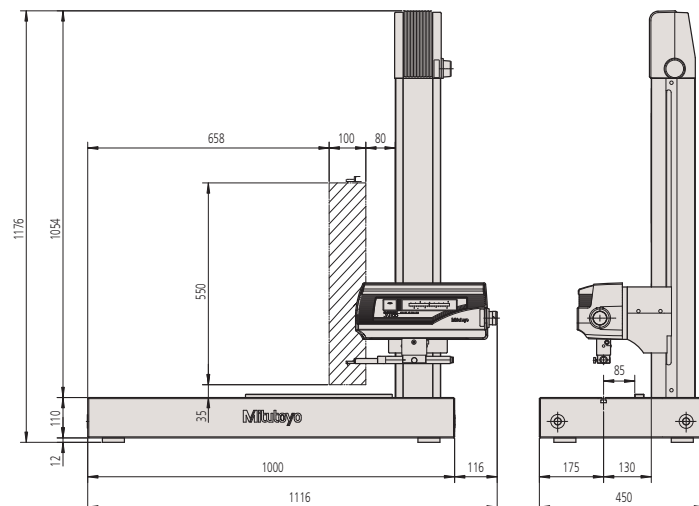

T-groove dimensions
(common to all types)



Measuring range

Optional Accessories

Manual column stand: 178-085 (for SJ-500)

Suitable for desktop use in inspection rooms and such.

No.178-085 * Except measuring unit
 Vertical adjustment range: 11.8" (300mm)
 Dimension (W x D x H): 23.6" x 17.7" x 28"
 (600 x 450 x 710mm)
 Weight: 242 lbs (110kg)



Dimensions of SJ-500 with manual column stand Unit: mm

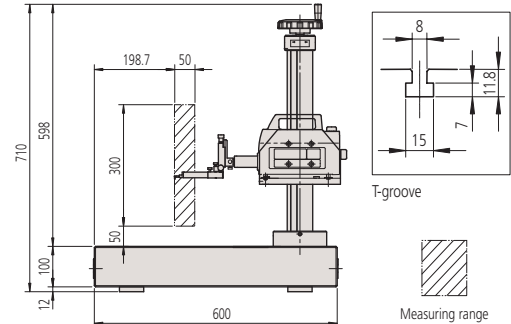

Auto-leveling table: 178-081 (for SJ-500 / SV-2100M4), 178-083 (for SV-2100S4 / H4 / W4)

This is a stage that performs fully automatic leveling as measurement starts, freeing the user from this tedious operation. Fully automatic leveling can be done quickly by anyone. In addition, the operation is easy and reliable.



Inclination adjustment angle	±2°
Maximum load	15.4 lbs (7kg)
Table dimensions	5.12" x 3.94" (130x100mm)
Mass	7.7lbs (3.5kg)



DAT leveling table: 178-048



Inclination adjustment angle	±1.5°
Maximum load	15.4 lbs (7kg)
Table dimensions	5.12" x 3.94" (130x100mm)

This table can be used by itself or in conjunction with other leveling tables.

Leveling table: 178-043-1 (with analog heads) 178-042-1 (with digital heads)

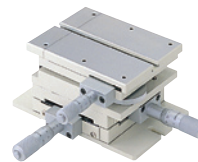

No.178-043-1



No.178-042-1

Order No.	178-043-1	178-042-1
Table dimensions	5.12" x 3.94" (130x100mm)	
Maximum load	33 lbs (15kg)	
Inclination adjustmnt. angle	±1.5°	
Swiveling angle	±3°	
XY-axis travel range	±0.49" (±12.5mm)	
Resolution	0.01mm	0.001mm
Dimensions	8.66" x 7.4" x 3.27" (220x189x83mm)	10.3" x 9.17 x 3.27" (262x233x83mm)
Mass	13.2 lbs (6Kg)	13.9 lbs (6.3Kg)

Quick chuck: 211-032

This chuck is useful when measuring small workpieces. The knurled ring makes clamping very easy.



Retention range	Inner latch	OD: \varnothing 0.039" - 1.42" (1 - 36mm)
	Inner latch	ID: \varnothing 0.55" - 2.76" (14 - \varnothing 70m)
	Outer latch	OD: \varnothing 0.039 - 2.95" (1 - \varnothing 75mm)
Dimensions	\varnothing 4.64 x 1.61" (118x41mm)	
Mass	2.65 lbs (1.2kg)	

Micro-chuck: 211-031

This chuck is suitable for clamping extra-small diameter workpieces (\varnothing 1mm or less), which cannot be clamped with the centering chuck.



Clamping range	OD: \varnothing 0 - 0.06" (0 - 1.5mm)
Dimensions	\varnothing 4.64" - 1.91" (118x48.5mm)
Mass	1.32 lbs (0.6kg)

Optional Accessories

3-axis adjustment table: 178-047

This table helps make the alignment adjustments required when measuring cylindrical surfaces. The corrections for the pitch angle and the swivel angle are determined from a preliminary measurement and the Digimatic micrometers are adjusted accordingly. A flat-surfaced workpiece can also be leveled with this table.



Inclination adjustment angle	±1.5°
Swiveling angle	±2°
Y-axis range	0.49" ±(12.5mm)
Resolution of heads	0.001mm
Table dimensions	5.12" x 3.94" (130x100mm)
Maximum load	33 lbs (15kg)

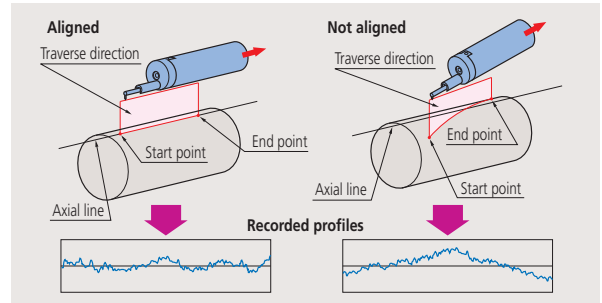

System configuration including optional accessories (for SV-2100M4 / S4 / H4 / W4)

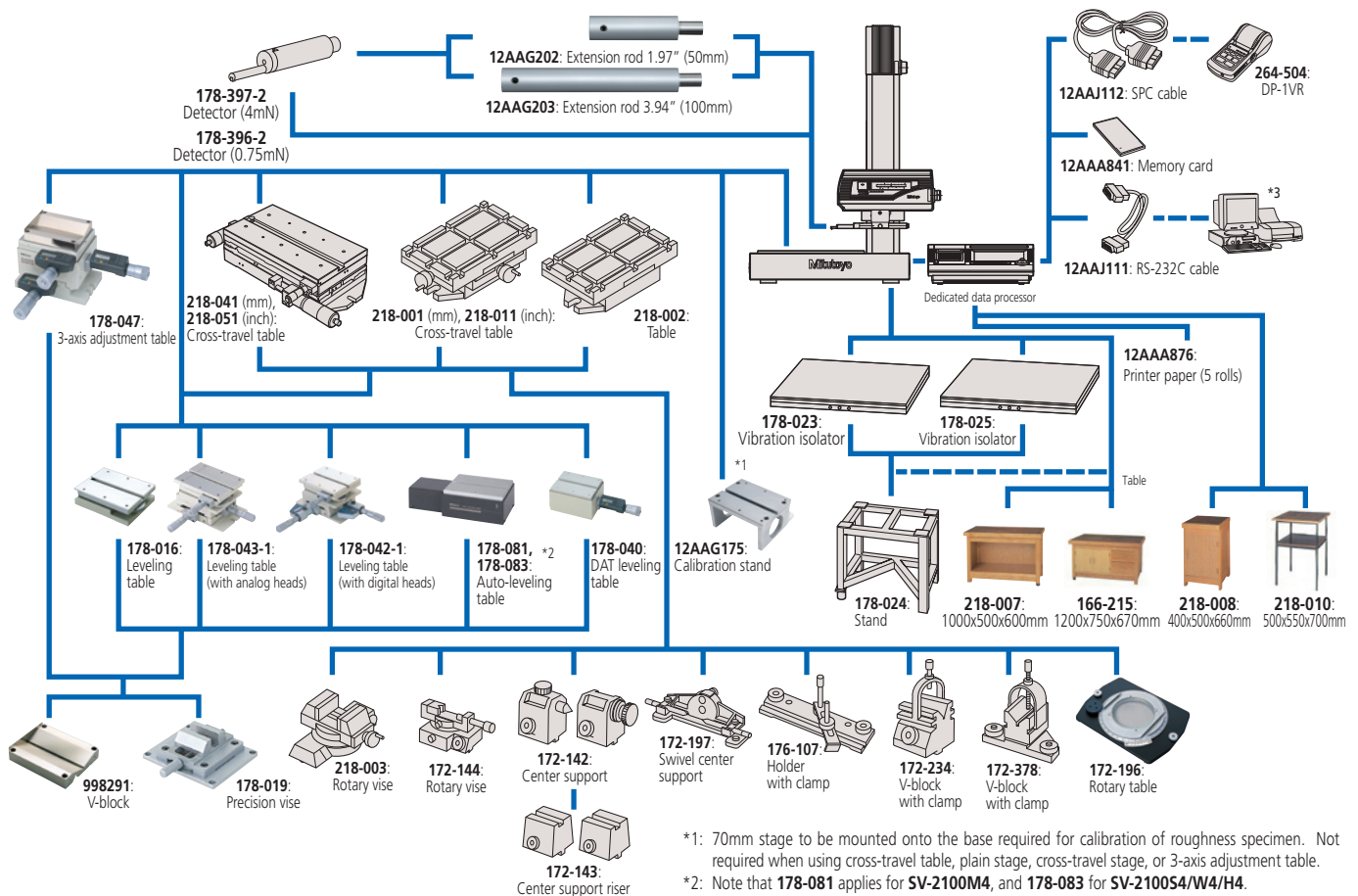

*1: 70mm stage to be mounted onto the base required for calibration of roughness specimen. Not required when using cross-travel table, plain stage, cross-travel stage, or 3-axis adjustment table.

*2: Note that 178-081 applies for SV-2100M4, and 178-083 for SV-2100S4/W4/H4.

*3: PC for managing the analysis result externally output from the dedicated data processor.

Optional Accessories

System configuration including optional accessories (for SJ-500 with optional manual column stand)

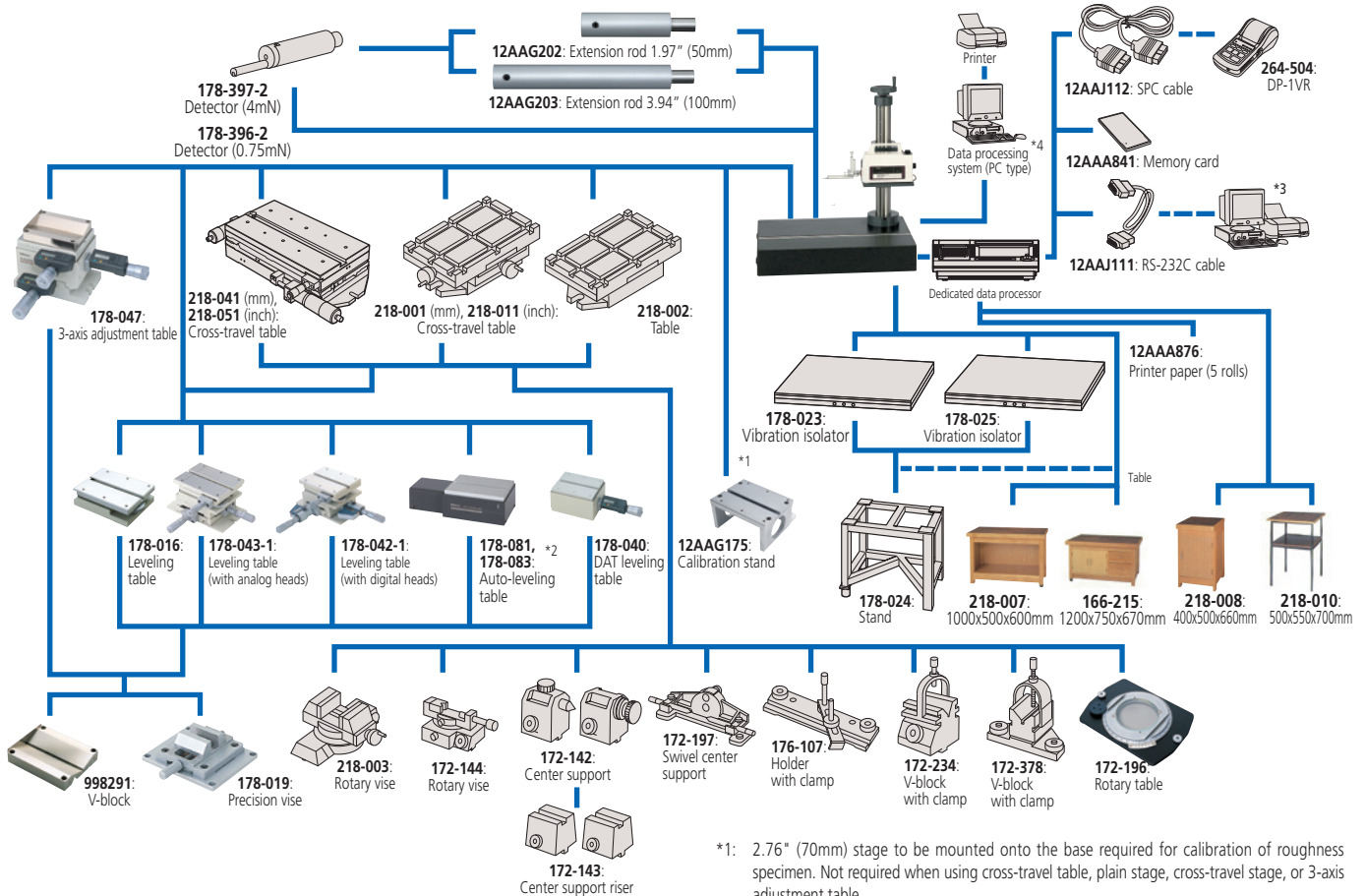

- *1: 2.76" (70mm) stage to be mounted onto the base required for calibration of roughness specimen. Not required when using cross-travel table, plain stage, cross-travel stage, or 3-axis adjustment table.
- *2: PC for managing the analysis result externally output from the dedicated data processor.
- *3: Only SJ-500P can be connected. Use a USB cable when connecting the SJ-500P main unit and a PC. A USB cable is a standard accessory of the SJ-500P.

Roughness specimen (standard accessory): 178-601

Display	Ra = about 3 μm
Material	Ni (TiN surface coating)

Reference step specimen: 178-611 (mm), 178-612 (inch)

For sensitivity calibration of detector

Nominal value of step	2μm 10μm, 79μin 394μin
-----------------------	------------------------

Roughness specimen: 178-604

For checking stylus tip

Display	Ra = about 3 μm, about 0.4 μm
---------	-------------------------------



Optional Styli

Detectors

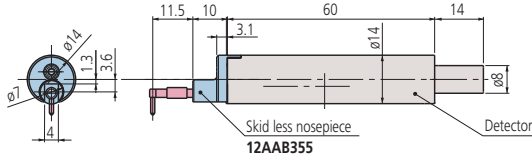

Detector (0.75mN): **178-396-2**
 Detector (4mN): **178-397-2**

Extension rods

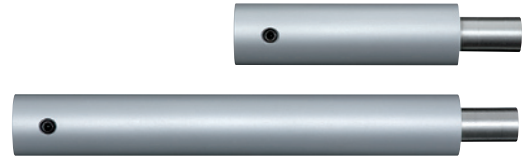

Extension rods
 (12AAG202: 1.97" (50mm), 12AAG203: 3.94" (100mm))

Styli

Standard stylus

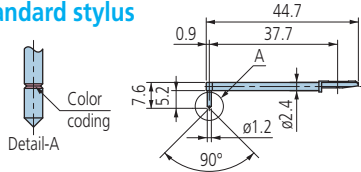

12AAE882 (1µm)*
 12AAE924 (1µm)**
 12AAC731 (2µm)*
 12AAB403 (5µm)**
 12AAB415 (10µm)**
 12AAE883 (250µm)**
 (): Tip radius
 *Tip angle: 60° **Tip angle: 90°

Double-length for deep hole

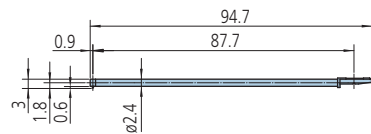

12AAE898 (2µm)*
 12AAE914 (5µm)**
 (): Tip radius
 *Tip angle: 60°
 **Tip angle: 90°

For small hole

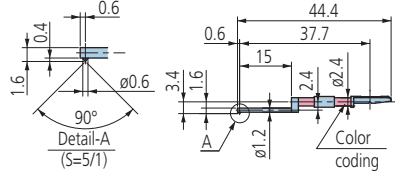

12AAC732 (2µm)*
 12AAB404 (5µm)**
 12AAB416 (10µm)**
 (): Tip radius
 *Tip angle: 60° **Tip angle: 90°

For small hole/Double-length for deep hole

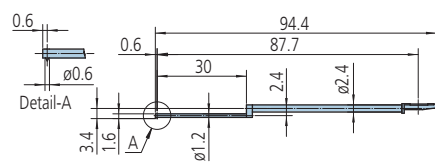

12AAE892 (2µm)*
 12AAE908 (5µm)**
 (): Tip radius
 *Tip angle: 60°
 **Tip angle: 90°

For very small hole

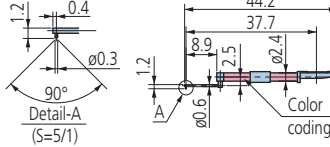

12AAC733 (2µm)*
 12AAB405 (5µm)**
 12AAB417 (10µm)**
 (): Tip radius
 *Tip angle: 60° **Tip angle: 90°

For very small hole

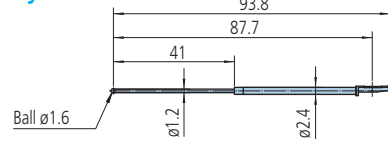

12AAE884 (0.8mm)
 (): Tip radius

For extra small hole

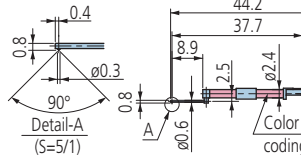

12AAC734 (2µm)*
 12AAB406 (5µm)**
 12AAB418 (10µm)**
 (): Tip radius
 *Tip angle: 60° **Tip angle: 90°

For ultra small hole

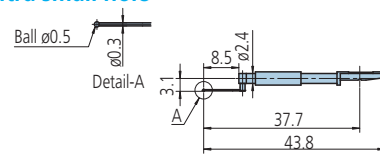

12AAJ662 (0.25mm)
 (): Tip radius

For deep hole (double-length and triple-length)

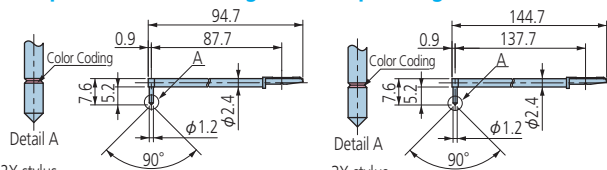

2X stylus
 12AAC740 (2µm)* (): Tip radius
 12AAB413 (5µm)** *Tip angle: 60°
 12AAB425 (10µm)** **Tip angle: 90°

3X stylus
 12AAC741 (2µm)* (): Tip radius
 12AAB414 (5µm)** *Tip angle: 60°
 12AAB426 (10µm)** **Tip angle: 90°

For small slotted hole

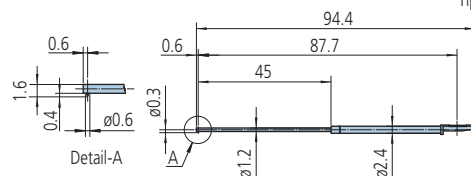

12AAE938 (2µm)*
 12AAE940 (5µm)**
 (): Tip radius
 *Tip angle: 60° **Tip angle: 90°

Styli

For deep groove (10mm)

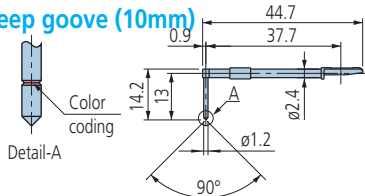

12AAC735 (2 μ m)*
 12AAB409 (5 μ m)**
 12AAB421 (10 μ m)**
 () : Tip radius
 *Tip angle: 60°
 **Tip angle: 90°

For deep groove (20mm)/Double-length for deep hole

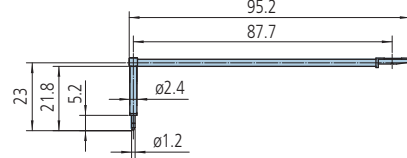

12AAE893 (2 μ m)*
 12AAE909 (5 μ m)**
 () : Tip radius
 *Tip angle: 60°
 **Tip angle: 90°

For deep groove (20mm)

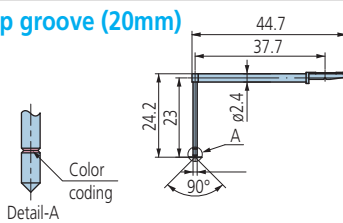

12AAC736 (2 μ m)*
 12AAB408 (5 μ m)**
 12AAB420 (10 μ m)**
 () : Tip radius
 *Tip angle: 60°
 **Tip angle: 90°

For deep groove (40mm)

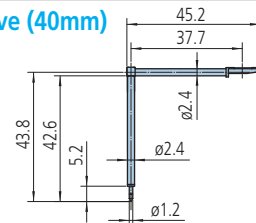

12AAE895 (2 μ m)*
 12AAE911 (5 μ m)**
 () : Tip radius
 *Tip angle: 60°
 **Tip angle: 90°

For deep groove (30mm)

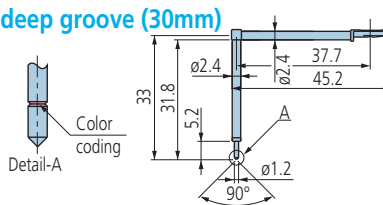

12AAC737 (2 μ m)*
 12AAB407 (5 μ m)**
 12AAB419 (10 μ m)**
 () : Tip radius
 *Tip angle: 60°
 **Tip angle: 90°

For deep groove (30mm)/Double-length for deep hole

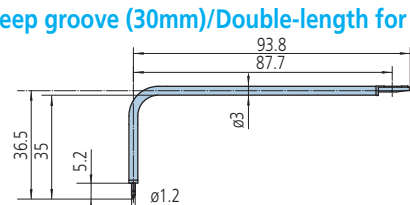

12AAE894 (2 μ m)*
 12AAE910 (5 μ m)**
 () : Tip radius
 *Tip angle: 60°
 **Tip angle: 90°

For gear tooth

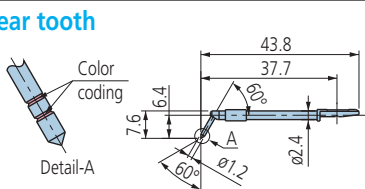

12AAB737 (2 μ m)*
 12AAB410 (5 μ m)**
 12AAB422 (10 μ m)**
 () : Tip radius
 *Tip angle: 60° **Tip angle: 90°

For gear tooth/Double-length for deep hole

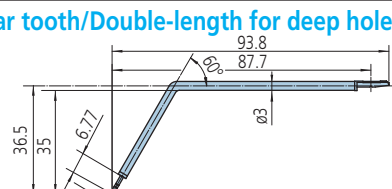

12AAE896 (2 μ m)*
 12AAE912 (5 μ m)**
 () : Tip radius

For rolling circle waviness surface

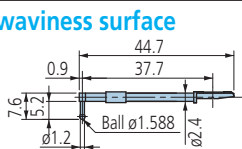

12AAB338 (ϕ 1.588)
 () : Tip radius

For rolling circle waviness/Double-length for deep hole

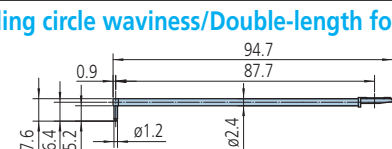

12AAE886 (250 μ m)
 () : Tip radius

For knife-edge detector

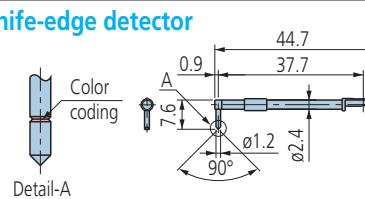

12AAC738 (2 μ m)*
 12AAB411 (5 μ m)**
 12AAB423 (10 μ m)**
 () : Tip radius
 *Tip angle: 60°
 **Tip angle: 90°

For corner hole/Double-length for deep hole

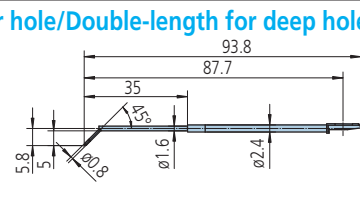

12AAE897 (2 μ m)*
 12AAE913 (5 μ m)**
 () : Tip radius
 *Tip angle: 60°
 **Tip angle: 90°

For eccentric arm

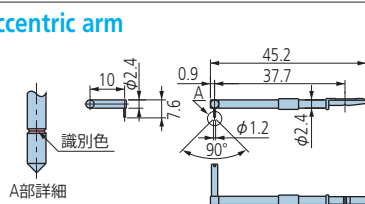

12AAC739 (2 μ m)*
 12AAB412 (5 μ m)**
 12AAB424 (10 μ m)**
 () : Tip radius
 *Tip angle: 60°
 **Tip angle: 90°

For bottom surface

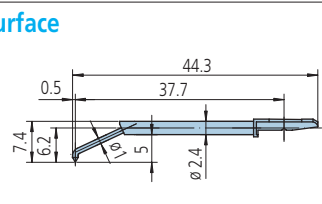

12AAE899 (2 μ m)*
 12AAE915 (5 μ m)**
 () : Tip radius
 *Tip angle: 60°
 **Tip angle: 90°



Note: All information regarding our products, and in particular the illustrations, drawings, dimensional and performance data contained in this printed matter as well as other technical data are to be regarded as approximate average values. We therefore reserve the right to make changes to the corresponding designs. The stated standards, similar technical regulations, descriptions and illustrations of the products were valid at the time of printing. In addition, the latest applicable version of our General Trading Conditions will apply. Only quotations submitted by ourselves may be regarded as definitive.

Mitutoyo products are subject to US Export Administration Regulations (EAR). Re-export or relocation of Mitutoyo products may require prior approval by an appropriate governing authority.

Trademarks and Registrations

Designations used by companies to distinguish their products are often claimed as trademarks. In all instances where Mitutoyo America Corporation is aware of a claim, the product names appear in initial capital or all capital letters. The appropriate companies should be contacted for more complete trademark and registration information.

We reserve the right to change specifications and prices without notice.