

Willrich Precision
Ph 866-945-5742
email: sales@willrich.com



CRYSTA-APEX S SERIES

High-performance, low-price CNC coordinate measuring machine meets global standards.

COORDINATE
MEASURING MACHINES



CNC Coordinate Measuring Machine CR

High accuracy in the 1.7 μm class

The CRYSTA-Apex S is a high-accuracy CNC coordinate measuring machine that guarantees a maximum permissible error of $*E_{0,MPE} = (1.7+3L/1000)\mu\text{m}$ [500/700/900 Series]. Let's compare the CRYSTA-Apex S with CMMs offering $*E_{0,MPE}$ of approximately $(2.5+4L/1000)\mu\text{m}$. If, for example, the required tolerance on a dimension is $\pm 0.02\text{ mm}$, then the measuring machine uncertainty should be no more than one-fifth (ideally one-tenth) of that, i.e. $4\mu\text{m}$. This means that with a general-purpose CMM, when the measured length exceeds 14.8" (375mm), machine uncertainty exceeds one-fifth of the dimension tolerance in this case. In contrast, as shown in the figure on the right, with the CRYSTA-Apex S the measurement uncertainty remains within one-fifth of the dimension tolerance up to 30.2" (766mm). The higher accuracy specification of the CRYSTA-Apex S, therefore, gives it more than double the effective measuring range in terms of accuracy-guarantee capability in this case.
*ISO 10360-2:2009

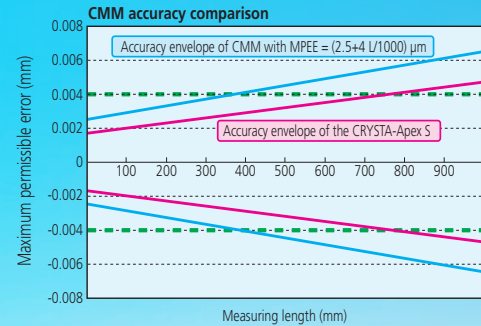

Temperature compensation system

The CRYSTA-Apex S comes equipped with a temperature compensation system that guarantees the accuracy of measurement under temperature conditions of 60.8 to 78.8 °F (16 to 26 °C). From sensors installed on each axis scale and working in conjunction with sensors placed on the workpiece, temperatures are obtained before outputting the measurement result to the controller. Thermal compensation is applied based on 68 °F (20 °C), taking into account the workpiece material expansion coefficient. The combined axis scale/workpiece temperature compensation design used on the CRYSTA-Apex S gives superior results compared to systems with sensors only on the axis scales.

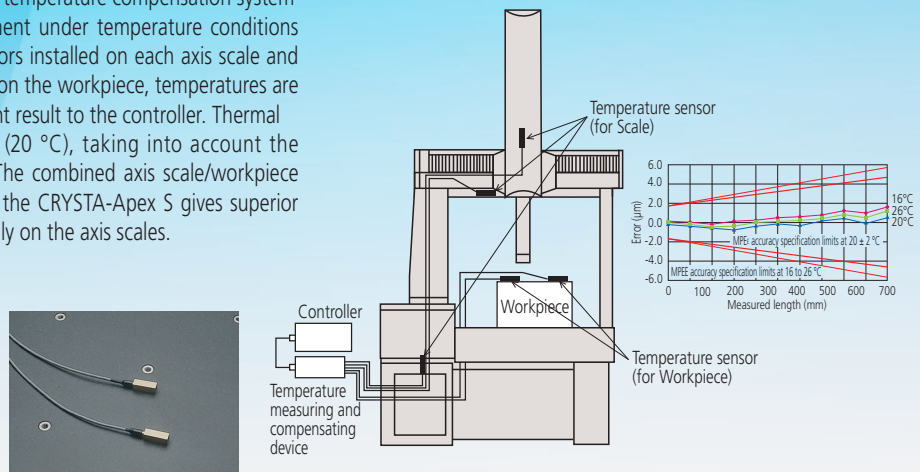

500 Series



CRYSTA-Apex S544

700 Series



CRYSTA-Apex S776

900 Series



CRYSTA-Apex S9106

YSTA-Apex S Series

High-speed, high-acceleration drive

The CRYSTA-Apex S Series offers a maximum drive speed of 693mm/s (27.2"/s) [1600/2000 Series], and a maximum acceleration of 2,309mm/s² (7.57"/s²) [500/700/900 Series], resulting in an increase of almost 270mm in drive distance in one second, when compared with general-purpose CNC coordinate measuring machines (with a maximum speed of 430mm/s (16.9"/s) and a maximum acceleration of 1,667mm/s² (5.46"/s²).

Furthermore, with a maximum measuring speed (i.e., the speed with which the stylus traces over the workpiece) of 8mm/s (0.31"/s), the CRYSTA-Apex S produces measurements more quickly than ordinary CMMs (with a maximum measuring speed of 5mm/s (0.19"/s)). Combining high speed and high acceleration, the CRYSTA-Apex S reduces measuring time. As the number of measuring points increases, measuring costs per point are further reduced.

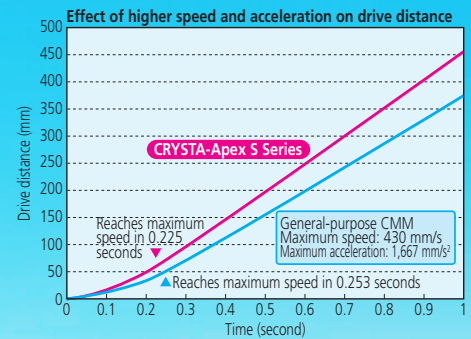

Designed for high rigidity

As is the case with Mitutoyo's conventional CMMs, various structures are employed in the CRYSTA-Apex S in order to give the body higher rigidity. The Y-axis guide rail, which is integrated to one side of the granite surface plate, shows little deterioration with use and, therefore, maintains the stated accuracy much longer. The air bearings located on the bottom face, in addition to those at the front, rear, and upper surfaces of the slider unit of the X-axis, minimize vibration even during high-speed, high-acceleration movement, thus ensuring stable linear motion.

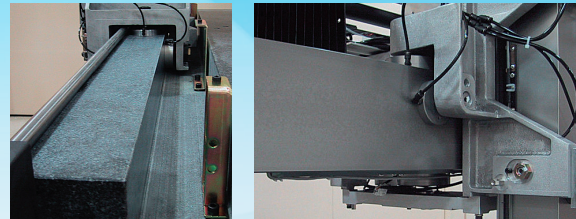

Integrated Y-Axis in Granite Table

1200 Series



CRYSTA-Apex S122010

1600/2000 Series



Crysta-Apex S163016

NOTE: PC and workstation differ from those shown.

CRYSTA-Apex S 500 Series



NOTE: PC and workstation differ from those shown.

Note: This machine incorporates a main unit startup system (relocation detection system), which disables operation when an unexpected vibration is applied or the machine is relocated. After initial installation, be sure to contact your nearest Mitutoyo sales office prior to relocation.

CRYSTA-Apex S500 Series Dimensions unit: inch (mm)

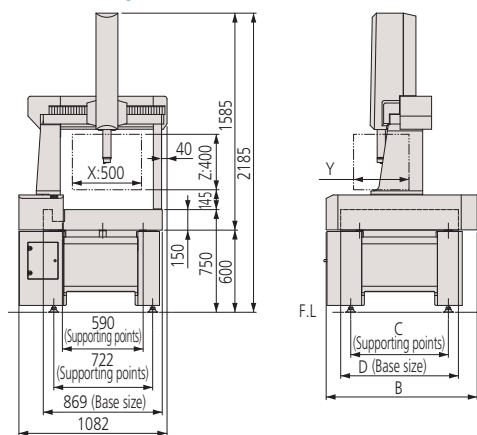

Measuring Table (Tapped Insert) Dimensions (unit: mm)

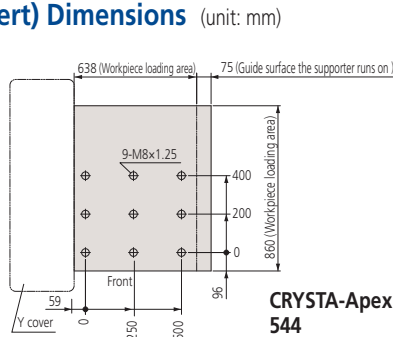

CRYSTA-Apex S
544

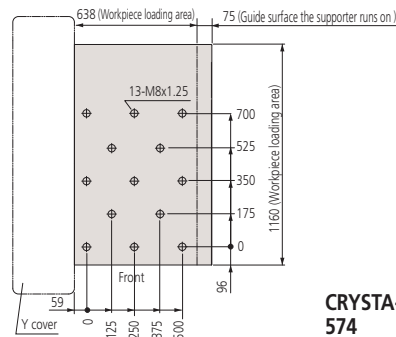

CRYSTA-Apex S
574

Model No.		CRYSTA-Apex S544	CRYSTA-Apex S574
Measuring range	X axis	19.68" (500mm)	
	Y axis	15.74" (400mm)	27.55" (700mm)
	Z axis	15.75" (400mm)	
Resolution	0.000004" (0.0001mm)		
Guide method	Air bearings on each axis		
Drive speed	8-300mm/s (CNC mode), max. speed: 519mm/s 0 - 80mm/s (J/S Mode: High Speed) 0 - 3mm/s (J/S Mode: Low Speed) 0.05mm/s (J/S Mode: Fine Speed)		
Max. measuring speed	8mm/s		
Max. drive acceleration	2,309 mm/s ² (3D)		
Workpiece	Maximum height	21.45" (545mm)	
	Maximum mass	396.8lbs. (180kg)	
Mass (including the control device and installation platform)		1,135lbs. (515kg)	1,377lbs. (625kg)
	Pressure	58 PSI (0.4MPa)	
Air supply	Consumption	1.76CFM (50L/min) under normal conditions	
	Air source	3.53CFM (100L/min)	

CRYSTA-Apex S500 Series Accuracy unit: μm

Probe used	Maximum permissible error (E _{0,MPE}) ISO 10360-2:2009	Maximum permissible probing error (P _{FTU,MPE}) ISO 10360-5:2010
SP25M (Stylus: ø4 X 50mm)	1.7+3 L/1000 (temperature environment 1) 1.7+4 L/1000 (temperature environment 2)	1.7
TP200 (Stylus: ø4 X 10mm)	1.9+3 L/1000 (temperature environment 1) 1.9+4 L/1000 (temperature environment 2)	1.9
TP20 (Stylus: ø4 X 10mm)	2.2+3 L/1000 (temperature environment 1) 2.2+4 L/1000 (temperature environment 2)	2.2

* L = Selected measuring length (in mm).

* Table below describes temperature environments 1 and 2.

CRYSTA-Apex S500 Series Accuracy ISO 10360-4 unit: μm

Probe used	Max. permissible scanning error (MPE _{THP})
SP25M (Stylus: ø4 X 50 mm)	2.3μm (50s)

CRYSTA-Apex S500 Series Installation Temperature

		Temperature environment 1	Temperature environment 2
Limits within which accuracy is guaranteed	Temperature Range	20±2 °C (64.4-71.6 °F)	16 - 26 °C (60.8-78.8 °F)
	Rate of change	2 °C per hour or less 2 °C in 24 hours or less	2 °C per hour or less 5 °C in 24 hours or less
	Gradient	1 °C or less per meter	1 °C or less per meter

Installation Floor Space unit: inch (mm)

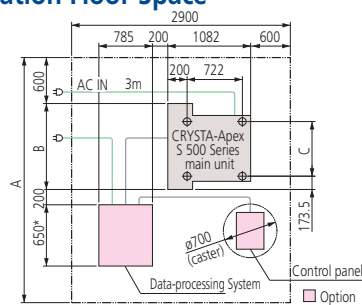

* When a mouse table is used: 850 mm
When a 2-monitor dedicated rack is used: 1,000 mm

Model No.	A	B	C	D	Y
CRYSTA-Apex S544	126" (3200)	44.2" (1122)	28.1" (713)	33.9" (860)	16.1" (405)
CRYSTA-Apex S574	138" (3500)	57.5" (1458)	39.9" (1013)	45.7" (1160)	27.8" (705)

CRYSTA-Apex S 700 Series



NOTE: PC and workstation differ from those shown.

Note: This machine incorporates a main unit startup system (relocation detection system), which disables operation when an unexpected vibration is applied or the machine is relocated. After initial installation, be sure to contact your nearest Mitutoyo sales office prior to relocation.

CRYSTA-Apex S700 Series Dimensions unit: inch (mm)

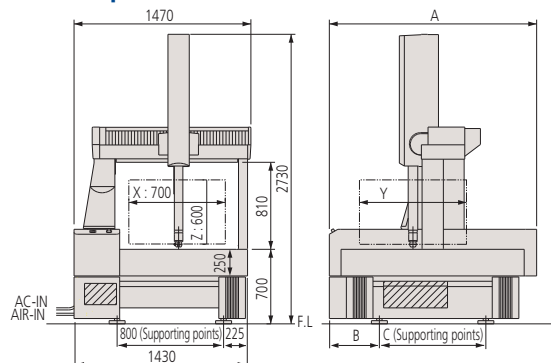

Model No.	A	B	C	Y
CRYSTA-Apex S776	65" (1650)	16.5" (420)	32" (800)	27.8" (705)
CRYSTA-Apex S7106	76.8" (1950)	18.5" (470)	39.4" (1000)	39.6" (1005)

Measuring Table (Tapped Insert) Dimensions (unit: mm)

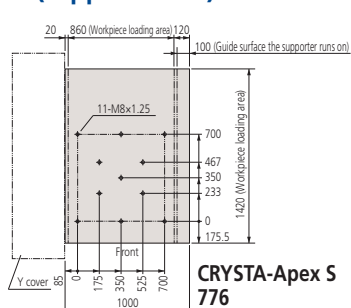

CRYSTA-Apex S
776

Model No.		CRYSTA-Apex S776	CRYSTA-Apex S7106
Measuring range	X axis	27.6" (700mm)	
	Y axis	27.55" (700mm)	39.36" (1000mm)
	Z axis	23.62" (600mm)	
Resolution	0.000004" (0.0001mm)		
Guide method	Air bearings on each axis		
Drive speed	8-300mm/s (CNC mode), max. speed: 519 mm/s 0 - 80mm/s (J/S Mode: High Speed) 0 - 3mm/s (J/S Mode: Low Speed) 0.05mm/s (J/S Mode: Fine Speed)		
Max. measuring speed	8 mm/s		
Max. drive acceleration	2,309 mm/s ² (3D)		
Workpiece	Maximum height	31.49" (800mm)	
	Maximum mass	1,763lbs. (800kg)	2,204lbs. (1000kg)
Mass (including the control device and installation platform)	3,692lbs. (1675kg)		4,301lbs. (1951kg)
Air supply	Pressure	58 PSI (0.4MPa)	
	Consumption	1.76CFM (50L/min) under normal conditions	
	Air source	3.53CFM (100L/min)	

CRYSTA-Apex S700 Series Accuracy ISO 10360-2 unit: μm

Probe used	Maximum permissible error (E _{0,MPE}) ISO 10360-2:2009	Maximum permissible probing error P _{FTU,MPE} ISO 10360-5:2010
SP25M (Stylus: ø4 X 50mm)	1.7+3 L/1000 (temperature environment 1) 1.7+4 L/1000 (temperature environment 2)	1.7
TP200 (Stylus: ø4 X 10mm)	1.9+3 L/1000 (temperature environment 1) 1.9+4 L/1000 (temperature environment 2)	1.9
TP20 (Stylus: ø4 X 10mm)	2.2+3 L/1000 (temperature environment 1) 2.2+4 L/1000 (temperature environment 2)	2.2

* L = Selected measuring length (in mm).

* Table below describes temperature environments 1 and 2.

CRYSTA-Apex S700 Series Accuracy ISO 10360-4 unit: μm

Probe used	Max. permissible scanning error (MPE _{THP})
SP25M (Stylus: ø4 X 50 mm)	2.3μm (50s)

CRYSTA-Apex S 700 Series Installation Temperature

Limits within which accuracy is guaranteed	Temperature Range	Temperature environment 1	Temperature environment 2	
	Rate of change	20±2 °C (64.4-71.6 °F)	2 °C per hour or less 2 °C in 24 hours or less	16 - 26 °C (60.8-78.8 °F) 2 °C per hour or less 5 °C in 24 hours or less
	Gradient		1 °C or less per meter	1 °C or less per meter

Installation Floor Space unit: inch (mm)

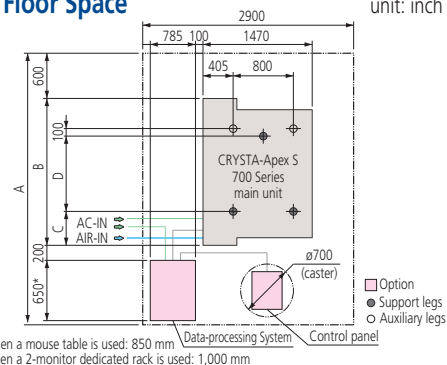

* When a mouse table is used: 850 mm
When a 2-monitor dedicated rack is used: 1,000 mm

Model No.	A	B	C	D
CRYSTA-Apex S776	130" (3300)	65" (1650)	16.5" (420)	32" (800)
CRYSTA-Apex S7106	142" (3600)	76.8" (1950)	18.5" (470)	39.4" (1000)

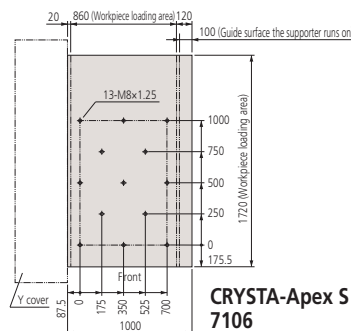

CRYSTA-Apex S
7106

Mitutoyo

CRYSTA-Apex S 900 Series



NOTE: PC and workstation differ from those shown.

Note: This machine incorporates a main unit startup system (relocation detection system), which disables operation when an unexpected vibration is applied or the machine is relocated. After initial installation, be sure to contact your nearest Mitutoyo sales office prior to relocation.

CRYSTA-Apex S900 Series Dimensions unit: inch (mm)

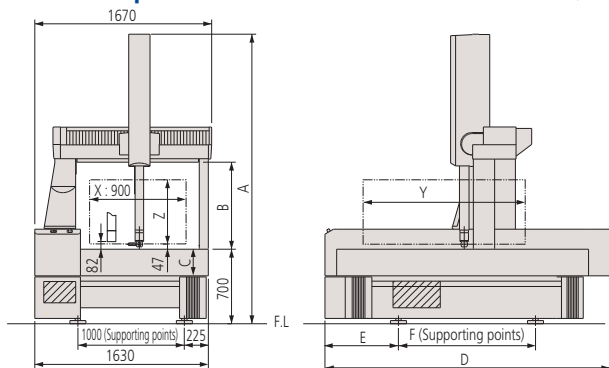

Model No.	A	B	C	D	E	F	Y	Z
CRYSTA-Apex S9106			10" (250)	76.8" (1950)	18.5" (470)	39.4" (1000)	39.6" (1005)	
CRYSTA-Apex S9166	107.5" (2730)	32" (800)	10" (250)	106" (2690)	27.6" (700)	52" (1320)	63.2" (1605)	23.8" (605)
CRYSTA-Apex S9206			11.8" (300)	121.7" (3090)	32" (800)	59.1" (1500)	79" (2005)	
CRYSTA-Apex S9108			10" (250)	76.8" (1950)	18.5" (470)	39.4" (1000)	39.6" (1005)	
CRYSTA-Apex S9168	123.3" (3130)	39.4" (1000)	10" (250)	106" (2690)	27.6" (700)	52" (1320)	63.2" (1605)	32.1" (805)
CRYSTA-Apex S9208			11.8" (300)	121.7" (3090)	32" (800)	59.1" (1500)	79" (2005)	

Measuring Table (Tapped Insert) Dimensions (unit: mm)

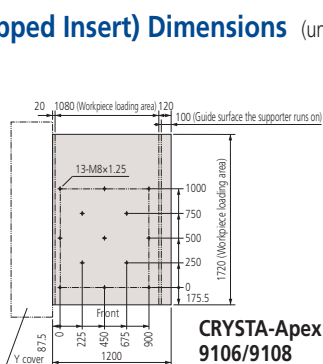

CRYSTA-Apex S
9106/9108

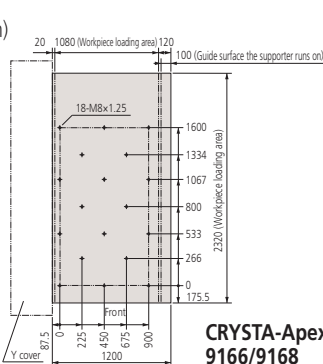

CRYSTA-Apex S
9166/9168

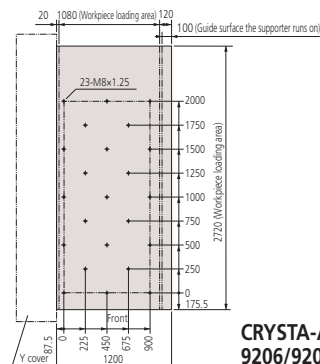

CRYSTA-Apex S
9206/9208

Model No.		CRYSTA-Apex S 9106 / [9108]	CRYSTA-Apex S 9166 / [9168]	CRYSTA-Apex S 9206 / [9208]
Measuring range	X axis	35.43" (900mm)		
	Y axis	39.36" (1000mm)	62.99" (1600mm)	78.3" (2000mm)
	Z axis	23.62" (600mm) / [31.49" (800mm)]		
Resolution	0.000004" (0.0001mm)			
Guide method	Air bearings on each axis			
Drive speed	8 - 300mm/s (CNC mode), max. speed: 519mm/s 0 - 80mm/s (J/S Mode: High Speed) 0 - 3mm/s (J/S Mode: Low Speed) 0.05mm/s (J/S Mode: Fine Speed)			
Max. measuring speed	8mm/s (3mm/s for Type Z800)			
Max. drive acceleration	2309mm/s ² [1732mm/s ²] (3D)			
Workpiece	Maximum height	31.49" (800mm) / [39.36" (1000mm)]		
	Maximum mass	2,645lbs. (1200kg)	3,306lbs. (1500kg)	3,968lbs. (1800kg)
Mass (including the control device and installation platform)		4,919lbs. (2231kg) [4,985lbs. (2261kg)]	6,322lbs. (2868kg) [6,389lbs. (2898kg)]	8,625lbs. (3912kg) [8,691lbs. (3942kg)]
	Pressure	58 PSI (0.4MPa)		
Air supply	Consumption	2.11CFM (60L/min) under normal conditions		
	Air source	4.23CFM (120L/min)		

CRYSTA-Apex S900 Series Accuracy ISO 10360-2 unit: μm

Probe used	Maximum permissible error (E _{0,MPE}) ISO 10360-2:2009	Maximum permissible probing error (P _{FTU,MPE}) ISO 10360-5:2010
SP25M (Stylus: ø4 X 50mm)	1.7+3 L/1000 (temperature environment 1) 1.7+4 L/1000 (temperature environment 2)	1.7
TP200 (Stylus: ø4 X 10mm)	1.9+3 L/1000 (temperature environment 1) 1.9+4 L/1000 (temperature environment 2)	1.9
TP20 (Stylus: ø4 X 10mm)	2.2+3 L/1000 (temperature environment 1) 2.2+4 L/1000 (temperature environment 2)	2.2

* L = Selected measuring length (in mm).

* Table below describes temperature environments 1 and 2.

CRYSTA-Apex S900 Series Accuracy ISO 10360-4 unit: μm

Probe used	Max. permissible scanning error (MPE _{THP})
SP25M (Stylus: ø4 X 50 mm)	2.3μm (50s) / [2.3μm (60s)]

CRYSTA-Apex S900 Series Installation Temperature

	Temperature environment 1	Temperature environment 2
Limits within which accuracy is guaranteed	Temperature Range 20±2 °C (64.4-71.6 °F)	16 - 26 °C (60.8-78.8 °F)
	Rate of change 2 °C per hour or less 2 °C in 24 hours or less	2 °C per hour or less 5 °C in 24 hours or less
	Gradient 1 °C or less per meter	1 °C or less per meter

Installation Floor Space

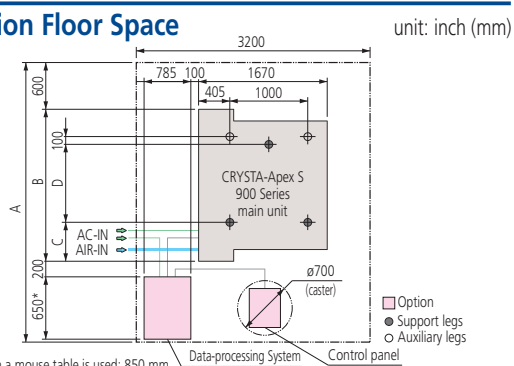

* When a mouse table is used: 850 mm
When a 2-monitor dedicated rack is used: 1,000 mm

Model No.	A	B	C	D
CRYSTA-Apex S9106/9108	142" (3600)	76.8" (1950)	18.5" (470)	39.4" (1000)
CRYSTA-Apex S9166/9168	169" (4300)	106" (2690)	27.6" (700)	52" (1320)
CRYSTA-Apex S9206/9208	185" (4700)	121.7" (3090)	32" (800)	59.1" (1500)

CRYSTA-Apex S 1200 Series



NOTE: PC and workstation differ from those shown.

Note: This machine incorporates a main unit startup system (relocation detection system), which disables operation when an unexpected vibration is applied or the machine is relocated. After initial installation, be sure to contact your nearest Mitutoyo sales office prior to relocation.

CRYSTA-Apex S1200 Series Dimensions unit: inch (mm)

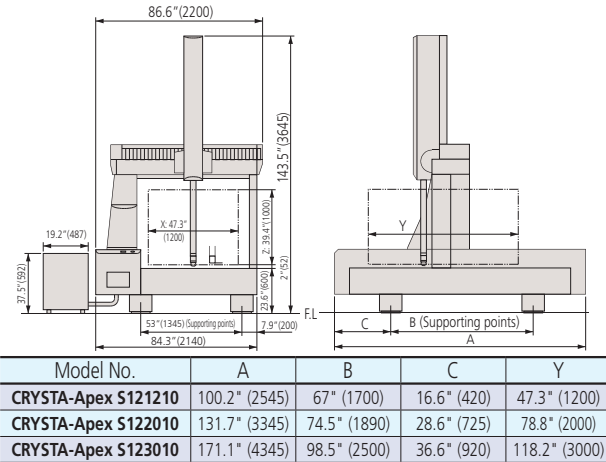

Measuring Table (Tapped Insert) Dimensions (unit: mm)

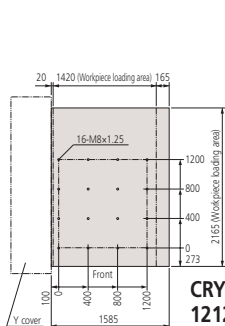

CRYSTA-Apex S 121210

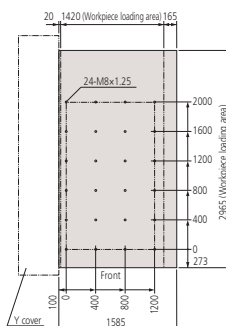

CRYSTA-Apex S 122010

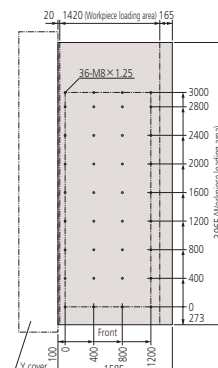

CRYSTA-Apex S 123010

Model No.		CRYSTA-Apex S 121210	CRYSTA-Apex S 122010	CRYSTA-Apex S 123010
Measuring range	X axis	47.24" (1200mm)		
	Y axis	47.24" (1200mm)	78.73" (2000mm)	118.10" (3000mm)
	Z axis	39.36" (1000mm)		
Resolution	0.000004" (0.0001mm)			
Guide method	Air bearings on each axis			
Drive speed	8 - 400 mm/s (CNC mode), max. speed: 693 mm/s 0 - 80 mm/s (J/S Mode: High Speed) 0 - 3 mm/s (J/S Mode: Low Speed) 0.05 mm/s (J/S Mode: Fine Speed)			
Max. measuring speed	5mm/s			
Max. drive acceleration	1,732 mm/s ² (3D)			
Workpiece	Maximum height	47.24" (1200mm)		
	Maximum mass	4,409lbs. (2000kg)	5,511lbs. (2500kg)	6,613lbs. (3000kg)
Mass (including the control device and installation platform)	8,928lbs. (4050kg)	13,558lbs. (6150kg)	20,084lbs. (9110kg)	
Air supply	Pressure	58 PSI (0.4MPa)		
	Consumption	100 L/min under normal conditions		
	Air source	5.29CFM (150L/min)		

CRYSTA-Apex S1200 Series Accuracy ISO 10360-2 unit: μm

Probe used	Maximum permissible error (E _{0,MPE}) ISO 10360-2:2009	Maximum permissible probing error (P _{FTH,MPE}) ISO 10360-5:2010
SP25M (Stylus: ø4 X 50mm)	2.3+3L/1000 (temperature environment 1) 2.3+4L/1000 (temperature environment 2)	2.0
TP200 (Stylus: ø4 X 10mm)	2.5+3L/1000 (temperature environment 1) 2.5+4L/1000 (temperature environment 2)	2.2
TP20 (Stylus: ø4 X 10mm)	2.8+3L/1000 (temperature environment 1) 2.8+4L/1000 (temperature environment 2)	2.6

* L = Selected measuring length (in mm).

* Table below describes temperature environments 1 and 2.

CRYSTA-Apex S 1200 Series Accuracy ISO 10360-4 unit: μm

Probe used	Max. permissible scanning error (MPE _{THP})
SP25M (Stylus: ø4 X 50 mm)	2.8μm (50s)

CRYSTA-Apex S1200 Series Installation Temperature

		Temperature environment 1	Temperature environment 2
Limits within which accuracy is guaranteed	Temperature Range	20±2 °C	16 - 26 °C
	Rate of change	2 °C per hour or less 2 °C in 24 hours or less	2 °C per hour or less 5 °C in 24 hours or less
	Gradient	1 °C or less per meter	1 °C or less per meter

Installation Floor Space

unit: inch (mm)

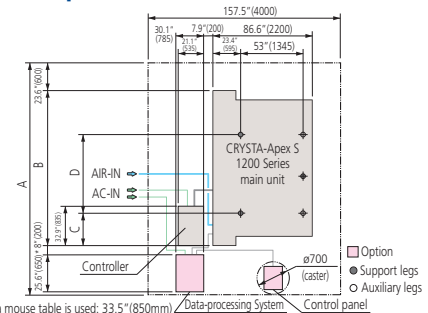

* When a mouse table is used: 33.5" (850mm) Data-processing System
When a 2-monitor dedicated rack is used: 39.4" (1000mm)

Model No.	A	B	C	D
CRYSTA-Apex S121210	163.2" (4145)	100.2" (2545)	16.6" (420)	67" (1700)
CRYSTA-Apex S122010	194.7" (4945)	131.7" (3345)	28.6" (725)	74.5" (1890)
CRYSTA-Apex S123010	234.1" (5945)	171.1" (4345)	36.3" (920)	98.5" (2500)

Crysta-Apex S 1600 Series



Note: This machine incorporates a main unit startup system (relocation detection system), which disables operation when an unexpected vibration is applied or the machine is relocated. After initial installation, be sure to contact your nearest Mitutoyo sales office prior to relocation.

CRYSTA-Apex S1600 Series Dimensions

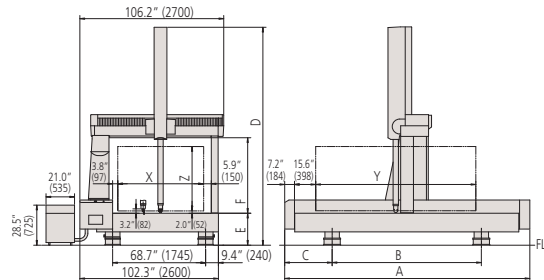

Model No.	A	B	C	D	E	F	X	Y	Z
CRYSTA-Apex S 162012/16	141.7" (3600)	70.8" (1800)	35.4" (900)	162.9" (4140)	23.6" (600)	55.1" (1400)	62.9" (1600)	78.7" (2000)	47.2" (1200)
CRYSTA-Apex S 163012/16	181.1" (4600)	103.9" (2640)	38.5" (980)	162.9" (4140)	23.6" (600)	55.1" (1400)	62.9" (1600)	118.1" (3000)	47.2" (1200)
CRYSTA-Apex S 164012/16	220.4" (5600)	134.6" (3420)	42.9" (1090)	164.9" (4190)	25.5" (650)	55.1" (1400)	62.9" (1600)	157.4" (4000)	47.2" (1200)

* () indicates Z: 1600 mm specification

Measuring Table (Tapped Insert) Dimension

(unit: mm)

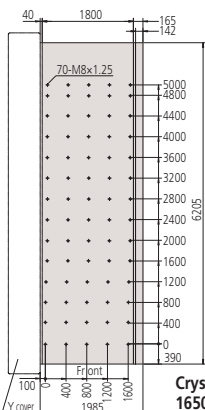

Crysta-Apex S
165012/165016

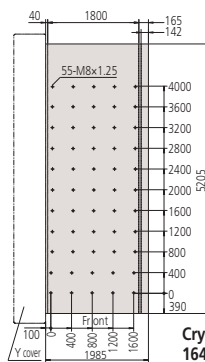

Crysta-Apex S
164012/164016

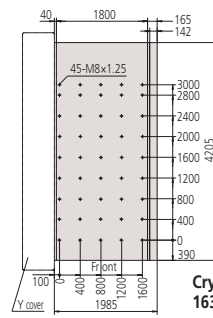

Crysta-Apex S
163012/163016

Model No.		CRYSTA-Apex S 162012/ [162016]	CRYSTA-Apex S 163012/ [163016]	CRYSTA-Apex S 164012/ [164016]
Measuring range	X axis	62.99" (1600mm)		
	Y axis	78.73" (2000mm)	118.10" (3000mm)	157.47" (4000mm)
	Z axis	47.24" (1200mm) / [62.99" (1600mm)]		
Resolution	0.000004" (0.0001mm)			
Guide method	Air bearings on each axis			
Drive speed	8 - 400mm/s (CNC mode), max. speed: 693mm/s 0 - 80mm/s (J/S Mode: High Speed) 0 - 3mm/s (J/S Mode: Low Speed) 0.05mm/s (J/S Mode: Fine Speed)			
Max. measuring speed	3 mm/s			
Max. drive acceleration	3D: 1.41G (1390mm/s ²)			
Workpiece	Maximum height	55.11" (1400mm) / [70.86" (1800mm)]		
	Maximum mass	6,613 lbs. (3000kg)	7,716 lbs. (3500kg)	9,920 lbs. (4500kg)
Mass (including the control device and installation platform)		20,502 lbs. (9300kg)	23,368 lbs. (10600kg)	32,628 lbs. (14800kg)
		[20,613 lbs. (9350kg)]	[23,479 lbs. (10650kg)]	[32,738 lbs. (14850kg)]
Air supply	Pressure	58 PSI (0.4MPa)		
	Consumption	5.29CFM (150L/min) under normal conditions		
	Air source	7.06CFM (200L/min)		

CRYSTA-Apex S1600 Series Accuracy

ISO 10360-2

unit: μ m

Probe used	Maximum permissible error (E _{0,MPE}) ISO 10360-2:2009		Maximum permissible probing error (E _{FTU,MPE}) ISO 10360-5:2010
	Temperature environment 1	Temperature environment 2	
SP25M (Stylus: ϕ 4 x 50 mm)	3.3+4.5L/1000 [4.5+5.5L/1000]	3.3+5.5L/1000 [4.5+6.5L/1000]	5.0 [6.0]
TP200 (Stylus: ϕ 4 x 10 mm)	6.0+4.5L/1000 [7.0+5.5L/1000]	6.0+5.5L/1000 [7.0+6.5L/1000]	6.5 [7.5]
TP20 (Stylus: ϕ 4 x 10 mm)	7.0+4.5L/1000 [8.0+5.5L/1000]	7.0+5.5L/1000 [8.0+6.5L/1000]	7.5 [8.5]

* L = Selected measuring length (in mm).

* Table below describes temperature environments 1 and 2.

* [] Indicates Z: 1600mm specifications

CRYSTA-Apex S1600 Series Accuracy

ISO 10360-4

unit: μ m

Probe used	Max. permissible scanning error (MPE _{THP})
SP25M (Stylus: ϕ 4 x 50 mm)	5.0 μ m (60s)

CRYSTA-Apex S1600 Series Installation Temperature

Limits within which accuracy is guaranteed	Temperature Range	Temperature environment 1	Temperature environment 2
	Rate of change	1 °C per hour or less	
		2 °C in 24 hours or less	
	Gradient	1 °C or less per meter	

Installation Floor Space

unit: inch (mm)

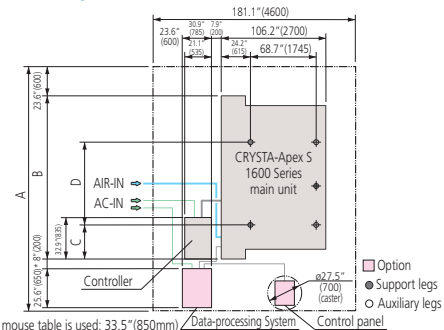

* When a mouse table is used: 33.5" (850mm)
 * When a 2-monitor dedicated rack is used: 39.4" (1000mm)

Model No.	A	B	C	D
Crysta-Apex S 162012/162016	244.0" [6200]	181.1" [4600]	38.5" [980]	103.9" [2640]
Crysta-Apex S 163012/163016	283.4" [7200]	220.4" [5600]	42.9" [1090]	134.6" [3420]
Crysta-Apex S 164012/164016	322.8" [8200]	259.8" [6600]	47.2" [1200]	165.3" [4200]

Crysta-Apex S 2000 Series



Note: This machine incorporates a main unit startup system (relocation detection system), which disables operation when an unexpected vibration is applied or the machine is relocated. After initial installation, be sure to contact your nearest Mitutoyo sales office prior to relocation.

Model No.		CRYSTA-Apex S203016	CRYSTA-Apex S204016
Measuring range	X axis	78.73" (2000mm)	
	Y axis	118.10" (3000mm)	157.47" (4000mm)
	Z axis	62.99" (1600mm)	
Resolution	0.000004" (0.0001mm)		
Guide method	Air bearings on each axis		
Drive speed	8 - 400mm/s (CNC mode), max. speed: 693mm/s 0 - 80mm/s (J/S Mode: High Speed) 0 - 3mm/s (J/S Mode: Low Speed) 0.05mm/s (J/S Mode: Fine Speed)		
Max. measuring speed	3 mm/s		
Max. drive acceleration	3D: 1.41G (1390mm/s ²)		
Workpiece	Maximum height	70.86" (1800mm)	
	Maximum mass	8,818 lbs. (4000kg)	11,023 lbs. (5000kg)
Mass (including the control device and installation platform)		31,085 lbs. (14100kg)	42,769 lbs. (19400kg)
	Pressure	58 PSI (0.4MPa)	
Air supply	Consumption	5.29CFM (150L/min) under normal conditions	
	Air source	7.06CFM (200L/min)	

CRYSTA-Apex S2000 Series Accuracy ISO 10360-2 unit: μm

Probe used	Maximum permissible error (E _{0,MPE}) ISO 10360-2:2009		Maximum permissible probing error (E _{FTH,MPE}) ISO 10360-5:2010
	Temperature environment 1	Temperature environment 2	
SP25M (Stylus: ø4 x 50 mm)	4.5+8L/1000	4.5+9L/1000	6.0
TP200 (Stylus: ø4 x 10 mm)	9+8L/1000	9+9L/1000	9.5
TP20 (Stylus: ø4 x 10 mm)	10+8L/1000	10+9L/1000	10.5

* L = Selected measuring length (in mm).

* Table below describes temperature environments 1 and 2.

CRYSTA-Apex S2000 Series Accuracy ISO 10360-4 unit: μm

Probe used	Max. permissible scanning error (MPET _{HP})
SP25M (Stylus: ø4 x 50 mm)	6.0μm (60s)

CRYSTA-Apex S2000 Series Installation Temperature

		Temperature environment 1	Temperature environment 2
Limits within which accuracy is guaranteed	Temperature Range	20±2 °C (64.4-71.6 °F)	16 - 24 °C (60.8-75.2 °F)
	Rate of change	1 °C per hour or less	
	Gradient	2 °C in 24 hours or less	5 °C in 24 hours or less
		1 °C or less per meter	

CRYSTA-Apex S2000 Series Dimensions

unit: inch (mm)

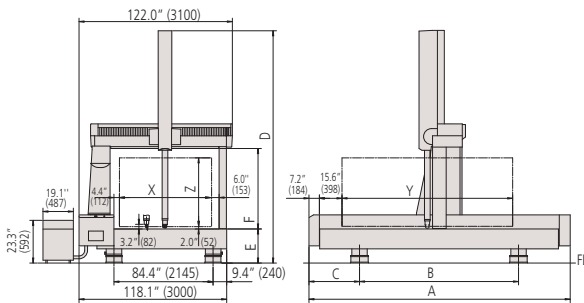

Model No.	A	B	C	D	E	F	X	Y	Z
Crysta-Apex S 203016	181.1" (4600)	103.9" (2640)	38.5" (980)	196.4" (4990)	25.5" (650)	70.8" (1800)	78.7" (2000)	118.1" (3000)	62.9" (1600)
Crysta-Apex S 204016	220.4" (5600)	134.6" (3420)	42.9" (1090)	198.4" (5040)	27.5" (700)	70.8" (1800)	78.7" (2000)	157.4" (4000)	62.9" (1600)

Installation Floor Space

unit: inch (mm)

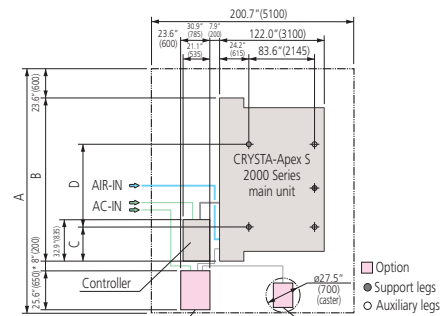

* When a mouse table is used: 33.5" (850mm) Data-processing System
When a 2-monitor dedicated rack is used: 39.4" (1000mm) Control panel

Model No.	A	B	C	D
Crysta-Apex S 203016	244.0" [6200]	181.1" [4600]	38.5" [980]	103.9" [2640]
Crysta-Apex S 204016	283.4" [7200]	220.4" [5600]	42.9" [1090]	134.6" [3420]

Measuring Table (Tapped Insert) Dimensions

(unit: mm)

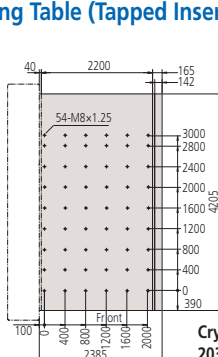

Crysta-Apex S 203016

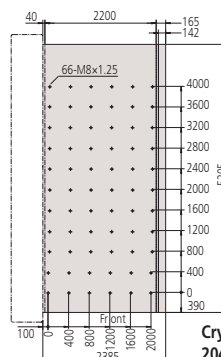

Crysta-Apex S 204016

Software and Probes

GEOPAK (general-purpose measurement program)

The GEOPAK module is the heart of the MCOSMOS software system and is used to measure and analyze geometric elements. All the functions are provided by icons or pull-down menus for ease of use. Main features include easier viewing of measuring procedures and results such as real-time graphic display of measurement results and a function for direct call-up of elements from results graphics.

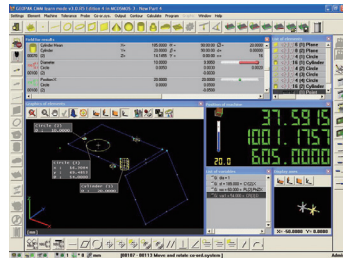

MiCAT Planner

Automatic measurement program generation software that uses 3D CAD with Product & Manufacturing Information (PMI) to enable one-click automated generation of measurement programs. With this program, a complex program that previously would have taken five hours to complete manually now can be completed in 15 minutes.

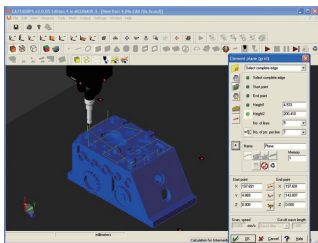
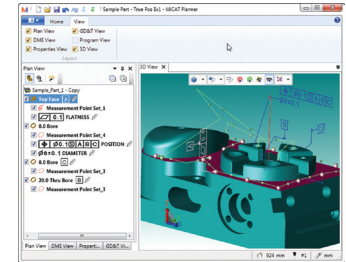

CAT1000 (CAD-based programming)

This module enables the user to use CAD data and on-screen simulation to create parts programs for making automated measurements. This module allows the user to begin creating a parts program as soon as the design data has been finalized, shortening the entire process.

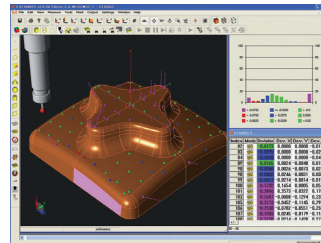

CAT1000S (freeform surface evaluation)

Checks and compares the workpiece with the CAD data containing freeform surfaces and directly outputs the results in the form of CAD data in various formats. Software that directly converts to/from various types of CAD data is available as an optional module.

SCANPAK (contour measurement program)

Software for scanning and evaluating workpiece contours (2D). Evaluates contour tolerance between measurement data and design data, and performs various types of element and inter-element calculations based on a desired range of measurement data specified by the user.

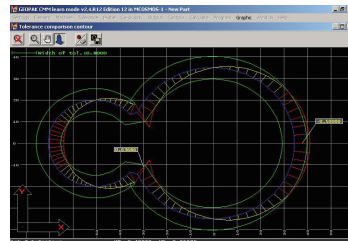

GEARPAK (gear evaluation)

For evaluating most types of involute, worm, and bevel/hypoid gears.

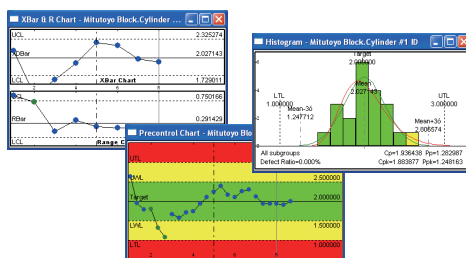
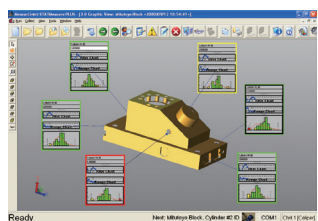
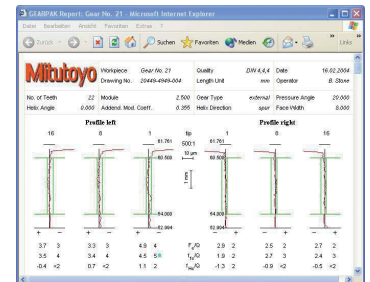

MeasurLink STATMeasure Plus (statistical control - SPC)

Performs various types of statistical computations using measurement results. In addition, by displaying a control diagram on a real-time basis, this program allows defects that may occur in the future (e.g., wearing or damaging of cutting tools) to be discovered early on. This program can also be linked to a higher-level network environment to build a central control system.

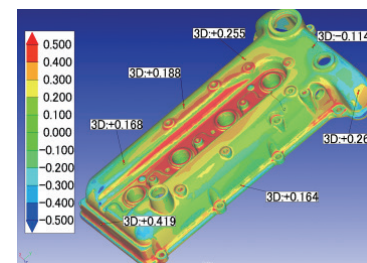

MSURF (non-contact laser measurement and evaluation)

MSURF-S is used to obtain measured point cloud data with the SurfaceMeasure (non-contact laser probe), while MSURF-I is used for comparing this data with the master model data, and for making dimensional measurements. Furthermore, MSURF-G for offline teaching allows the user to create a measurement macro even without the actual workpiece, improving the measuring machine's uptime.



SurfaceMeasure606T

SurfaceMeasure606T (non-contact laser probe)

Lightweight, high-performance, non-contact probe developed for CNC coordinate measuring machines. Spray-less powder measurement has been achieved through automatic setting of appropriate laser intensity and camera sensitivity according to environment or material, providing a simpler and more comfortable laser scanning environment.

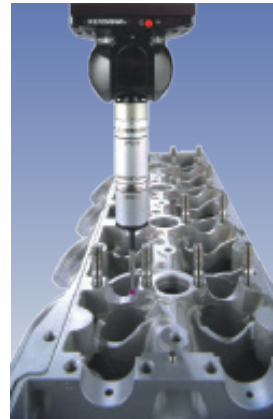

CMM Surftest Probe (surface roughness measuring)

Mitutoyo has a range of surface roughness analysis products from hand-held portable type up to CNC-type Surftest with broader functions and higher accuracy. Utilizing the technologies developed on our surface roughness measuring machines, our CMM's can perform surface roughness analysis by implementing a Surftest probe and the dedicated software. The Surftest probe requires PH10M or PH10MQ probe head.



Not available for Crysta Apex S500 series

Standard-type detector

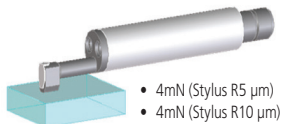

Small hole detector



Extra-small hole detector

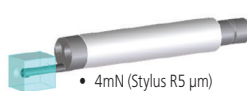

Deep groove detector



Gear-tooth surface detector

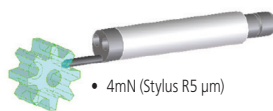

VISIONPAK (vision measurement program)

This program controls QVP and performs various computational analyses on captured images.

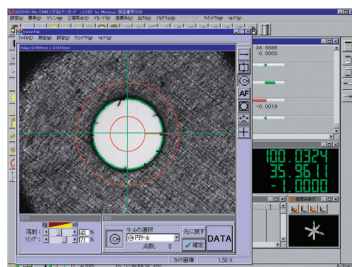

SP25M (compact high-accuracy scanning probe)

This is a compact, high-accuracy, multi-function scanning probe with a 25-mm outside diameter that makes scanning measurements, high-accuracy point measurements, and centripetal point measurements (optional function). The SP25M is used with the PH10MQ/10M auto probe head to provide a high degree of measurement freedom.

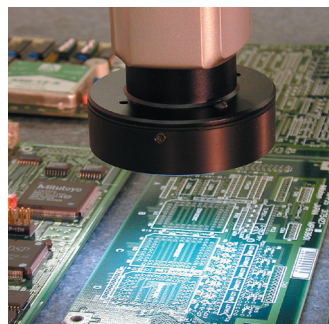

QVP (vision probe)

This probe automatically detects edges from image data of the workpiece magnified by a CCD camera. It is useful for measuring microfabricated products that cannot be measured using a contact-type probe and soft objects that cannot be subjected to any measurement force. The QVP can also be used for measuring height based on autofocus.

MPP-310Q (scanning probe)

Probe that collects coordinate values (point cloud data) at high accuracy by moving at speeds of up to of 120 mm/s while in contact with the workpiece. Because MPP-310Q can also be used with the rotary table (MRT320) for synchronous scanning, it is effective for measuring gears, blades, ball screws, cylindrical cams, etc.

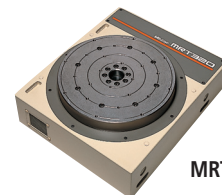

MRT320



Whatever your challenges are, Mitutoyo supports you from start to finish.

Mitutoyo is not only a manufacturer of top quality measuring products but one that also offers qualified support for the lifetime of the equipment, backed up by comprehensive services that ensure your staff can make the very best use of the investment.

Apart from the basics of calibration and repair, Mitutoyo offers product and metrology training, as well as IT support for the sophisticated software used in modern measuring technology. We can also design, build, test and deliver measuring solutions and even, if deemed cost-effective, take your critical measurement challenges in-house on a sub-contract basis.



Find additional product literature and our product catalog

www.mitutoyo.com

Note: All information regarding our products, and in particular the illustrations, drawings, dimensional and performance data contained in this printed matter as well as other technical data are to be regarded as approximate average values. We therefore reserve the right to make changes to the corresponding designs. The stated standards, similar technical regulations, descriptions and illustrations of the products were valid at the time of printing. In addition, the latest applicable version of our General Trading Conditions will apply. Only quotations submitted by ourselves may be regarded as definitive. Specifications are subject to change without notice.

Mitutoyo products are subject to US Export Administration Regulations (EAR). Re-export or relocation of our products may require prior approval by an appropriate governing authority.

Trademarks and Registrations

Designations used by companies to distinguish their products are often claimed as trademarks. In all instances where Mitutoyo America Corporation is aware of a claim, the product names appear in initial capital or all capital letters. The appropriate companies should be contacted for more complete trademark and registration information.



Mitutoyo America Corporation

www.mitutoyo.com
 One Number to Serve You Better
 1-888-MITUTOYO (1-888-648-8869)

M³ Solution Centers:

- Aurora, Illinois (Headquarters)
- Boston, Massachusetts
- Huntersville, North Carolina
- Mason, Ohio
- Plymouth, Michigan
- City of Industry, California
- Birmingham, Alabama
- Renton, Washington
- Houston, Texas