

Willrich Precision  
Ph 866-945-5742  
email: [sales@willrich.com](mailto:sales@willrich.com)



## MACH KO-GA-ME

AGILE MEASUREMENT SOLUTIONS

COORDINATE  
MEASURING MACHINES



# Rapid Near-Line/In-Line Measurement Solutions

A unique and compact CMM for automated measurements.

The MACH Ko-ga-me — a fast, compact, lightweight and easy-to-mount CMM — is the ideal solution for automated cells. The guaranteed accuracy temperature of 10°C to 35°C provides flexibility and performance in your production environment. Mounted on any rigid frame, including machine tools, the MACH Ko-ga-me will provide CMM capabilities without the space requirements of a full-sized machine and in-process measurement without setup and breakdown.

The small-sized 3-axis CNC measuring head incorporates high accuracy and high speed with the flexibility to implement numerous configurations for inspection applications in the quality lab or directly within the manufacturing process. The MACH Ko-ga-me's flexible design allows implementation to meet specific or multiple manufacturing applications:

- As a stand-alone inspection system in the quality lab or in the manufacturing environment, the MACH Ko-ga-me functions like any other CMM - parts can be placed in the measuring volume and measured individually or with a part program.
- As process inspection within computer-integrated manufacturing (CIM), the MACH Ko-ga-me can be implemented near line with operator part loading or in-line with robotic part loading for an automated closed-loop control process.

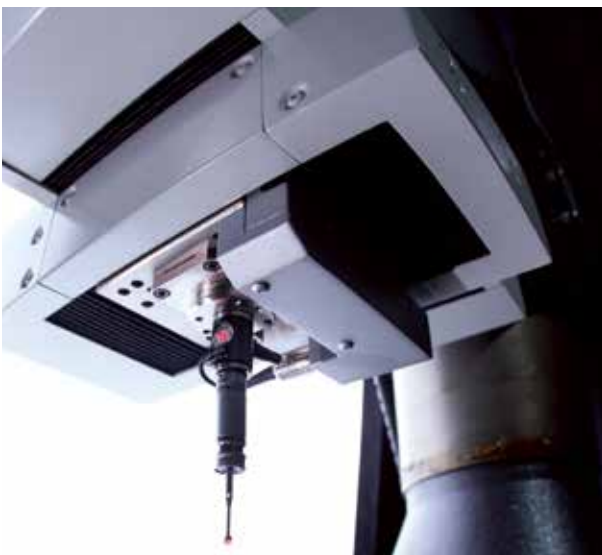

# Features & Benefits

## Versatility

Versatility of the MACH Ko-ga-me allows for quick and easy setup of applications. Modifications can be made on the fly and when critical features in the manufacturing process change. Without expensive masters to maintain, once the A2LA certified calibration is complete, only a simple master ball style probe calibration is necessary to achieve the continuous rated accuracy.

## Flexibility

Because the MACH Ko-ga-me is a compact CMM, it offers flexibility when production or manufacturing requirements change. It can be easily moved, reconfigured to handle a completely different part family or even used for general lab inspection. The MACH Ko-ga-me supports touch probe (TP200) or scanning probe (SP25) technology.

## Speed

With a maximum drive speed of 13.3"/sec (340mm/s), and an acceleration of 6,750mm/s<sup>2</sup> (0.68g), these high-speed capabilities provide the MACH Ko-ga-me the ability to rapidly acquire critical features, allowing for a quicker feedback and compensation of the manufacturing process, reducing scrap and increasing throughput.

## Minimal Site Preparation

With only a 120V 15A power requirement, no requirement for compressed air and a small footprint, the MACH Ko-ga-me can be used almost anywhere a need exists. The lightweight design allows for the unit to mount easily anywhere within the manufacturing process.

## Automation Ready

Using standard features of MCOSMOS, the world's standard in metrology software, MACH Ko-ga-me easily interfaces into factory automation and manufacturing cells. With extended I/O capability, interface to robots, conveyors, clamps and sensors is seamless.

## Guide Method

By utilizing a linear motion bearing design instead of air bearings, the MACH Ko-ga-me performs high-speed measuring without sacrificing accuracy.

## Environment

Designed to be used on the shop floor, using a sealed design and built-in thermal compensation, the MACH Ko-ga-me is accurate within a temperature range of 50~95° F (10~35° C).



Using a stand



Moving axis



Combined with a machine tool

# Applications

Automotive/ATV/Marine	
Pump Housings	Rocker Arms
Motors	Alternator Housings
Pistons	Bearing Races
Filter Assemblies	Piston Rods
Brake Components	Wheel Hubs
Fuel Lines	Throttle Body

Aerospace	
Implants	Impellers
Pumps	Surgical Instruments

Energy (Oil/Gas/Solar/Wind/Nuclear)	
Flanges	Fittings
Pumps	Housings
Couplings/Connections	Hardware

Injection Molding	
Molds	Bottles/Caps
Housings/Cases	Moldings

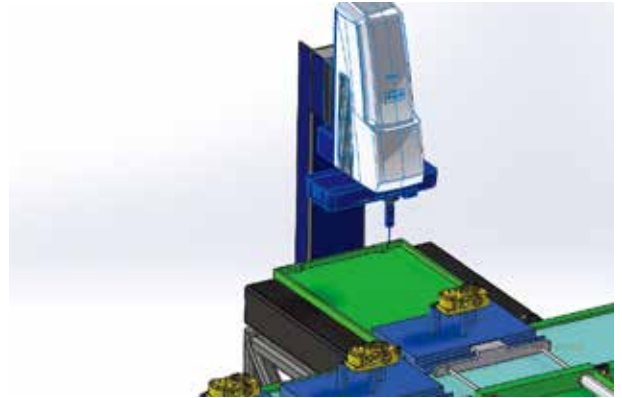

CAD system model with rendered Ko-ga-me for cell design

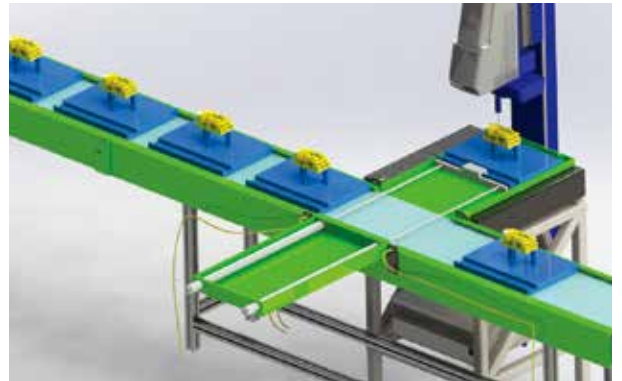

Fully conceptualized cell with animation

# Probe Systems

TP200 Specifications		
Measuring direction	$\pm X, \pm Y, \pm Z$	
Repeatability ( $2\sigma$ )	0.3 $\mu$ m or less (with 10mm stylus), 0.4 $\mu$ m or less (with the 50mm stylus)	
Directionality (XY: 2D)	$\pm 0.4\mu$ m or less (with 10mm stylus), $\pm 0.8\mu$ m or less (with the 50mm stylus)	
Directionality (XYZ: 3D)	$\pm 0.65\mu$ m or less (with 10mm stylus), $\pm 1\mu$ m or less (with the 50mm stylus)	
Required force to generate trigger signal	XY	0.02N (STANDARD/LOW FORCE), where a 50mm stylus is used
	Z	0.07N (STANDARD/LOW FORCE), where a 50mm stylus is used
Amount of over-travel	XY	$\pm 14^\circ$
	Z	+4.5mm (with 0.07N), +3mm (with 0.15N)
Required force to achieve over-travel	XY	0.35N (STANDARD FORCE) 0.1N (LOW FORCE)
	Z	4N (STANDARD FORCE) 1N (LOW FORCE)
Maximum stylus length		50mm (STANDARD FORCE)
		30mm (LOW FORCE)
Maximum stylus mass		8g (STANDARD FORCE), 3g (LOW FORCE)
Stylus mounting method		M2 screw

SP25M Specifications	
Measurement range	$\pm 0.5$ mm
Spring rate	0.4N/mm
Amount of over-travel	$\pm 2.0$ mm (XY) $\pm 1.7$ mm (Z)
Stylus mount	M3
Max. scanning speed	120mm/s [at a known geometry scanning]



# Specifications



Model No.	KGM 12128-B
Probe System	TP200 / SP25M
Measuring Range	4.72 x 4.7 x 3.14" (120mm x 120mm x 80mm)
Mass of Main Unit	62.0 lbs. (28kg)
Scale Resolution	0.00000078" (0.00002mm)
Accuracy	66.2 ~ 69.8°F (19 ~ 21°C): 2.4 + 5.7L/1000 59.0 ~ 77.0°F (15 ~ 25°C): 2.7 + 6.4L/1000 (E <sub>0,MPE</sub> ) 50.0 ~ 86.0°F (10 ~ 30°C): 3.1 + 7.2L/1000 50.0 ~ 95.0°F (10 ~ 35°C): 3.4 + 7.9L/1000 3 + 0.72L/100 (Temperature range 10°C - 35°C)
	(R <sub>0,MPL</sub> ) TP200: 1.9μm SP25: 1.3μm
	(P <sub>FTU,MPE</sub> ) 2.2μm
	(MPE <sub>THP</sub> ) 2.7μm/30sec
Max. Driving Speed	13.3"/s (340mm/s)
Acceleration	0.68G (6,750mm/s <sup>2</sup> )
Guiding Method	Linear motion bearing

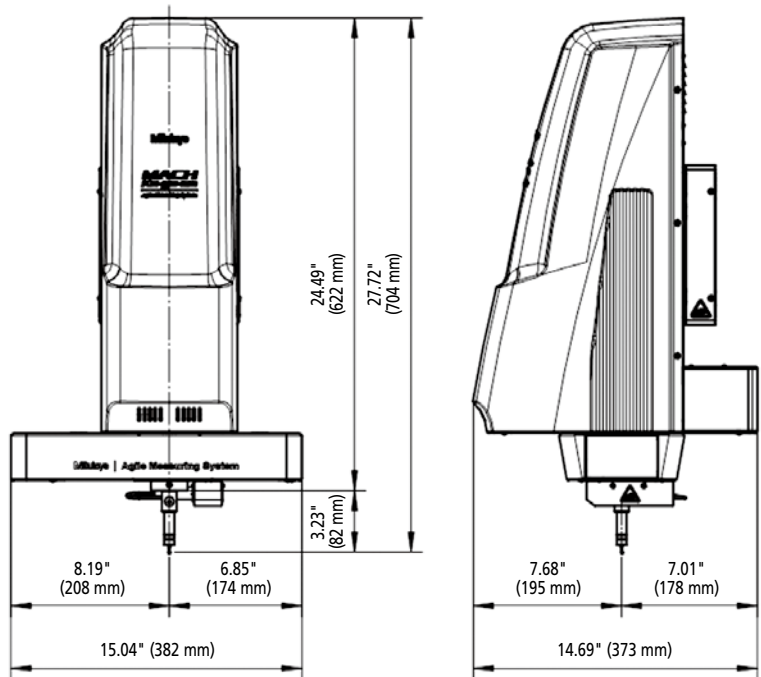

UC-400-K



# Mitutoyo Sales Solutions

Mitutoyo Sales Solutions is a group of highly skilled engineers specializing in the advanced application of Mitutoyo quality tools and CNC metrology equipment. With decades of combined experience in mechanical/electrical engineering and design, material handling and advanced metrology, their skills show in the many satisfied customers that utilize these services.

In the late 90s, through acquisition and merger of a well-established OEM gage builder, the Mitutoyo Sales Solutions Group was created, bringing decades of design and build of custom measurement systems and applications into the fold of Mitutoyo America Corporation's broad spectrum of metrology products and services. It was a natural fit and this new-found capability allowed Mitutoyo America Corporation to offer turnkey products and services to its' clients.

Mitutoyo Sales Solutions' mission is to bring value-added solutions to our customers, helping them to realize the maximum potential of their Mitutoyo investment. From turnkey application of our line of CNC machines to the most basic of indicators, Mitutoyo America Corporation and Mitutoyo Sales Solutions have resolutions for almost every measurement need. We are here to assist with your unique applications.

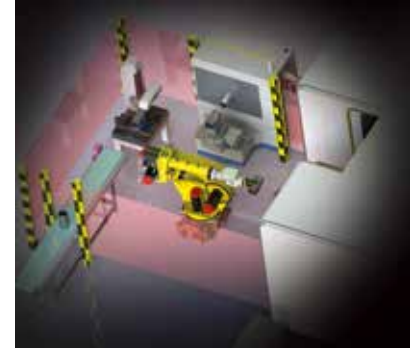

### Services:

- Fixture design/build
- 3D CAD concepts/renderings
- Reach & feasibility studies
- Turnkey capital projects
- Product implementation
- Custom styli/accessories
- Inline/near line gaging
- Custom software interfaces/patches
- "Green button" technology

Contact Information:

888-648-8869 • [www.Mitutoyo.com](http://www.Mitutoyo.com) • [Solutions@Mitutoyo.com](mailto:Solutions@Mitutoyo.com)

## Software

### MCOSMOS - GEOPAK CNC

The MACH Ko-ga-me is easily programmed using the standard MCOSMOS software. Programs can be made with the easy-to-use learn mode or from CAD model with CAT1000 via point and click.

GEOPAK provides visual tools, completely eliminating the use of difficult codes or abbreviated commands. A graphically enhanced display provides step-by-step, on-screen wizards that prompt the operator, allowing even inexperienced users to create routines to measure parts.

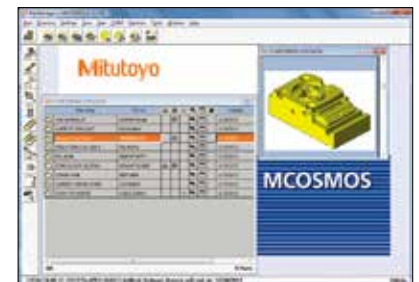

### MiCAT Planner

For fully automated part programming, the MACH Ko-ga-me can be programmed with MiCAT Planner, Mitutoyo's latest software development for fast and efficient CMM part programming. Programs are made with a few mouse clicks in minutes instead of hours or days.



### WORKFLOW:

- 1) Load design model
- 2) Select target CMM
- 3) Part placement via virtual alignment
- 4) Measurement program creation
- 5) Translate to Geopak MCOSMOS

### Design Model Support:

- Siemens NX w/PMI
- CATIA v5 w/PMI
- PRO/E w/PMI
- ACIS (SAT)



# MACH SERIES

## Solutions For Every Production Process

### MACH Ko-ga-me

- 1 Compact design for easy integration
- 2 High-speed measurements
- 3 Designed for production environment 50.0 ~ 95.0 °F (10 ~ 35 °C)
- 4 Extremely small footprint - perfect for automated cells and stand-alone solutions
- 5 Ideal for single-feature inspection and usable with scanning and point-to-point probes
- 6 Measuring range up to 120 mm
- 7 Resolution of 0.02µm and a measuring accuracy of (2.4 + 5.7L/1000)µm



### MACH-3A

- 1 High-speed (47.7" [1,212mm]/sec) and acceleration (1.2G [11,882mm/S<sup>2</sup>])
- 2 Small footprint minimizing production space requirements
- 3 Designed for production environment 41.0 ~ 104.0 °F (5 ~ 40 °C)
- 4 Optional index table
- 5 Probe changing capable
- 6 Measuring range up to 23.6" (600mm)
- 7 Resolution of 0.1µm and a measuring accuracy of (2.2 + 3.5L/1000)µm



### MACH-V

- 1 High-speed (34.0" [866mm]/sec) and acceleration (0.86G [8,480mm/S<sup>2</sup>])
- 2 Ideal for in-line integration
- 3 Designed for production environment 41.0 ~ 95.0 °F (5 ~ 35 °C)
- 4 Barycentric (center-of-mass) drive system for high speed and accuracy
- 5 Probe changing capable
- 6 Measuring range up to 39.3" (1000mm)
- 7 Resolution of 0.1µm and a measuring accuracy of (2.5 + 3.5L/1000)µm



### Thermal compensation - essential for in-line measurement

During production the temperature of a workpiece may differ from that of the measuring equipment due to the manufacturing processes. The MACH series of CMMs incorporate temperature compensation for both the CMM and workpiece.

To support in-line operations, the machine must continue accurate measurement (reference to 20°C) even while the size of a workpiece is changing due to this temperature difference.

The graph to the right shows the high degree of compensation resulting when a MACH-V series machine (at 20°C) measured a workpiece cooled from 40°C to 20°C.

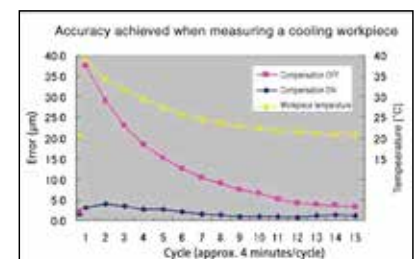



**Whatever your challenges are, Mitutoyo supports you from start to finish.**

Mitutoyo is not only a manufacturer of top-quality measuring products but one that also offers qualified support for the lifetime of the equipment, backed by comprehensive services that ensure your staff can make the very best use of the investment.

Apart from the basics of calibration and repair, Mitutoyo offers product and metrology training, as well as IT support for the sophisticated software used in modern measuring technology. We can also design, build, test and deliver measuring solutions and even, if deemed cost-effective, take your critical measurement challenges in-house on a sub-contract basis.



**Find additional product literature and our product catalog**

[www.mitutoyo.com](http://www.mitutoyo.com)

**Note:** All information regarding our products, and in particular the illustrations, drawings, dimensional and performance data contained in this printed matter as well as other technical data are to be regarded as approximate average values. We therefore reserve the right to make changes to the corresponding designs. The stated standards, similar technical regulations, descriptions and illustrations of the products were valid at the time of printing. In addition, the latest applicable version of our General Trading Conditions will apply. Only quotations submitted by ourselves may be regarded as definitive. Specifications are subject to change without notice.

Mitutoyo products are subject to US Export Administration Regulations (EAR). Re-export or relocation of our products may require prior approval by an appropriate governing authority.

**Trademarks and Registrations**

Designations used by companies to distinguish their products are often claimed as trademarks. In all instances where Mitutoyo America Corporation is aware of a claim, the product names appear in initial capital or all capital letters. The appropriate companies should be contacted for more complete trademark and registration information.

**Note:** MACH KO-GA-ME incorporates a main unit Startup system (relocation detection system), which disables operation when an unexpected vibration is applied or the machine is relocated. Be sure to contact your nearest Mitutoyo Sales Office prior to relocating this machine after initial installation.



**Mitutoyo America Corporation**

[www.mitutoyo.com](http://www.mitutoyo.com)  
 One Number to Serve You Better  
 1-888-MITUTOYO (1-888-648-8869)

**M<sup>3</sup> Solution Centers:**

- Aurora, Illinois (Headquarters)
- Boston, Massachusetts
- Huntersville, North Carolina
- Mason, Ohio
- Plymouth, Michigan
- City of Industry, California
- Birmingham, Alabama
- Renton, Washington
- Houston, Texas