



HEXAGON
MANUFACTURING INTELLIGENCE



TESA
TECHNOLOGY

PRODUCT BROCHURE



**WILLRICH PRECISION
INSTRUMENT**
THINK MEASUREMENT... THINK WILLRICH

Ph 866-945-5742 email:sales@willrich.com

TESA μ -HITE

THE μ LTRA COMPACT TURNKEY SOLUTION
FOR THE PRODUCTION LINE



A MEASURING STATION FOR MULTIPLE APPLICATIONS

The measuring station TESA μ -HITE is far more than a height gauge. This compact, robust, yet highly accurate instrument is designed for [measurement](#) operations [in the workshop](#), close to machining centres, as well as more controlled and secure inspection sites such as [laboratories](#).

With its [measuring range of 100 mm](#), this “all-in-one” station is particularly suitable for controlling small parts close to the production. It can even [replace the use of conventional 1D probes](#) which have a very limited measuring range and are often dedicated to a single application.



Its use in conjunction with the TESA MICRO-HITE height gauge control panel makes this system a significant advantage when it comes to [productivity](#). Indeed, its 'learning' mode coupled with its execution speed can positively impact the [output of a production line](#).

TESA μ -HITE therefore presents itself as a [simple access solution](#) but no less effective, [flexibility](#) is guaranteed when using a product adapted to a wide range of applications and user profiles.

THE SECURITY OF A PRODUCT OF QUALITY

The TESA products are since their development phase submitted to strict internal standards, aligned with the most restrictive national standards. Thanks to this tight monitoring, all the TESA gauges satisfy the quality charter that we strive to maintain as demanding as possible.



SCS certificate

Each TESA μ -HITE is delivered with a SCS (Swiss Calibration Service) certificate of measurement.

 *Any additional cost due to re-certification of the instrument after purchase is avoided.*



Clear information

No confusion! At any time, the displayed values correspond solely to a measurement or calculation and not to the instantaneous position of the probe.

 *Decrease of possible errors due to bad interpretations of the displayed results.*



A philosophy of use for everyone

With its refined user interface, ergonomic panel and context-based help, the TESA μ -HITE range is designed to be accessible to any user profile.

 *Short learning time, user autonomy reached within 1 day maximum.*

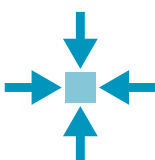

Compact & movable

With its small footprint, this measuring station can be integrated in any workshop. It can be moved easily, avoiding the great effort required to transfer a granite table of a standard height gauge.

 *Small footprint required for measurement close to machines or on a production line.*

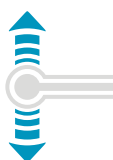

Flexible 1D probe with multiple advantages

Its "accuracy/measuring path" ratio allows it to be comparable with many commercially available 1D probes. Its performance goes far beyond the single measurement of simple heights, since it can also be used as a height gauge.

 *1. Can be used as a 1D probe (axial measurement) or as a height gauge (offset measurement)
2. Possibility to measure in two directions, which is not possible with 1D probes*

A turnkey solution

The use of one or more 1D probes necessarily implies the development of a particular fixing system defined for a single application type. This phase can be long and costly. On the contrary, the μ -HITE is a complete measuring station, easy to install and quickly operational.

 *1. Any extra cost due to the development of a fixing system (1D probes) or granite table (height gauges) is avoided
2. Time saving for the installation of the instrument
3. Quickly operational*



System can be integrated
in a production line

Adjustable height

Several data outputs
(USB & TLC)

TESA reading system
(patented)

opto μ *system*

Colour touch
screen

2 types of measure-
ments (axial
or offset)

Compact granite
table

Easily movable station

Switches (optional) for
fast execution

Refined backlit
keyboard





A refined backlit keyboard

With a simplified panel containing a number of keys reduced to the strictly necessary, the handling is easy, fast and does not leave room for confusion. The keyboard contains a backlight to improve the reading comfort at low-light areas in workshops.

1 key = 1 function
 It is no longer necessary to spend long hours learning how to use the instrument. The management of the capacities of the gauge is intuitive which allows to avoid hidden costs during the setting-in.

Hybrid panel

Each user has the possibility to choose between a 100% touch-use, via the control keyboard, or mixed. This makes the hybrid nature of this panel easy to use when navigating in the various menus as well as while managing measurement actions.

Comfortable and flexible use via the interaction of two navigation processes adapted to any type of environment of use.



Execution speed

Fast batch measurement is often the daily metrological challenge for many companies. This task quickly becomes tedious when done with conventional tools. Once parametrized, the TESA μ -HITE makes it possible to run a measurement sequence in a loop at a steady rhythm thanks to a foot switch freeing the hands of the operator to handle and sort parts.

- 1. Simple solution to set up for a significant time saving when measuring batches
- 2. Foot switch to minimize manual metrological actions and optimize the flow and management of the parts to be measured



Measurement automation

It is sometimes advantageous to integrate the metrology directly into a production line for time saving reasons. The TESA μ -HITE can be steered simply with special commands and allows for real-time control of objects that flow at a steady rate.

Easy steering of the μ -HITE for quick integration of the instrument and maximise the efficiency of the production line.

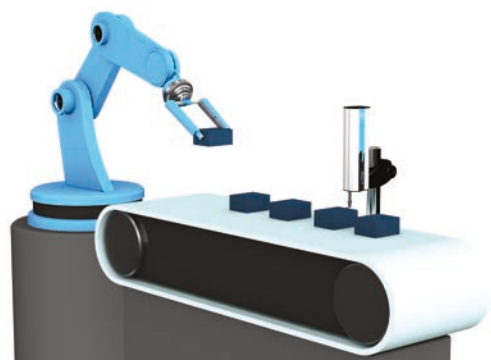

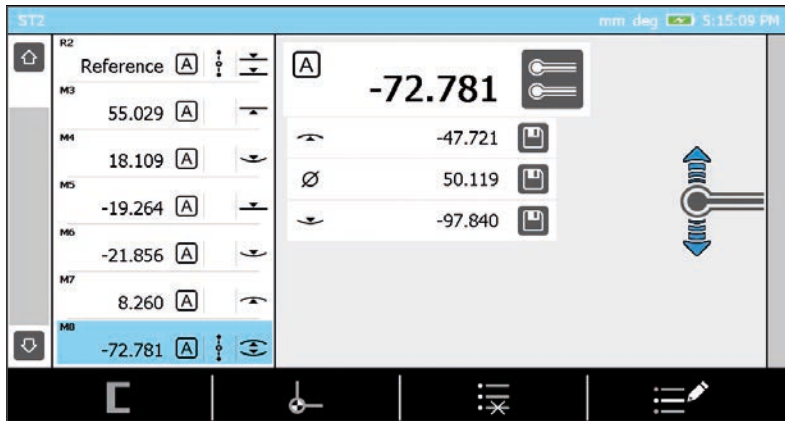

Clear Interface

Reading information is facilitated through clearly defined areas. This allows the user to concentrate on the essential points of his measurement without having to decrypt the displayed results.



1. Minimized learning time
2. User satisfaction
3. Minimized error rate
4. Better throughput

Intelligent user follow-up

During the whole using time, the μ-HITE shows automatically to the user the available options and gives step by step guides through the process. At the same time, a context-based function can be activated at any moment to access specific information concerning the mode or the active process.



As the user has access to a help, he is constantly guided and is never lost during the use. The context-based help is particularly welcome while learning how to use the gauge.

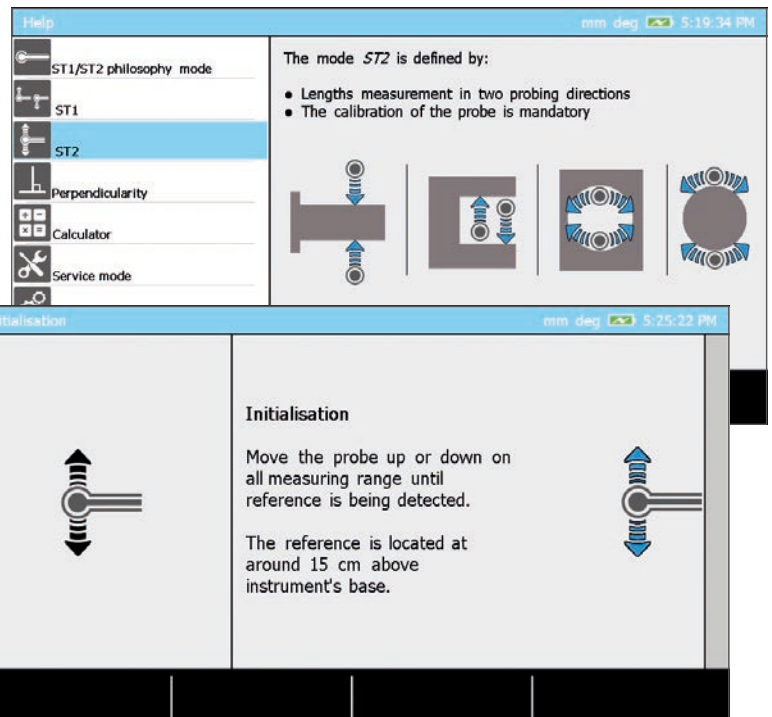

Advanced functions

As there are as many application cases as parts to measure, TESA developed a software that offers a range of possibilities to measure, going beyond the simple 1D function, like angle measurement, squareness deviation measurement or 2D measurement.



1. Multi-task instrument, accessible to everyone
2. Unique investment for numerous measuring possibilities
3. Quick return on investment

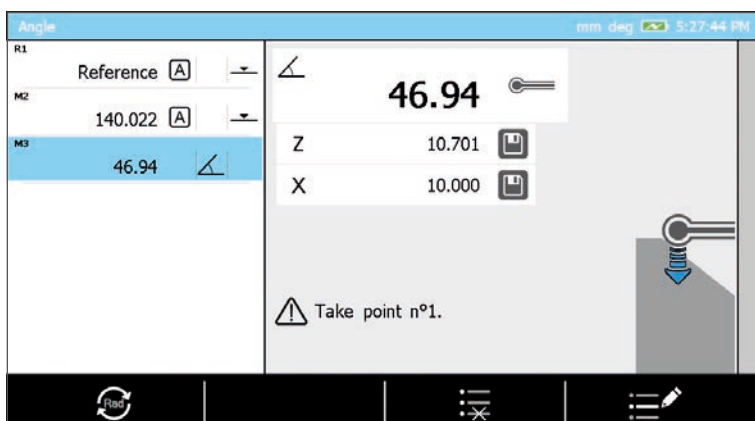

Customisable functions

With its integrated calculator, the control panel gives the possibility to perform calculations using directly the measuring results and to pre-configure calculation functions that will be automatically activated recalling a measuring program.

- 1. All instruments integrated = time gain
- 2. Creation of customised calculation functions adopted to real need
- 3. Integrated function to avoid reading errors

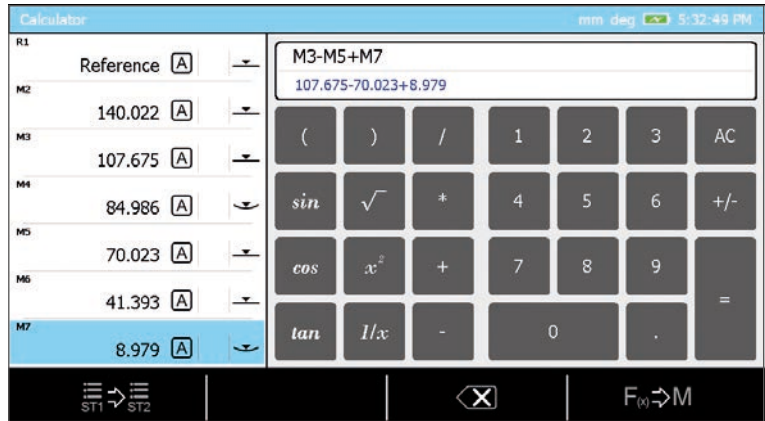

Program management

The μ-HITE is not only developed to easily perform quick measurements, but it is also thought to simplify sequential measurement of parts of the same batch. Once the measuring sequence is carried out on the first spare part “for learning”, the user can repeat it infinitely following the information displayed on the screen.

- Facilitated sequence creation measuring process. Gain of time and simplification of the process during the measurement of batches.

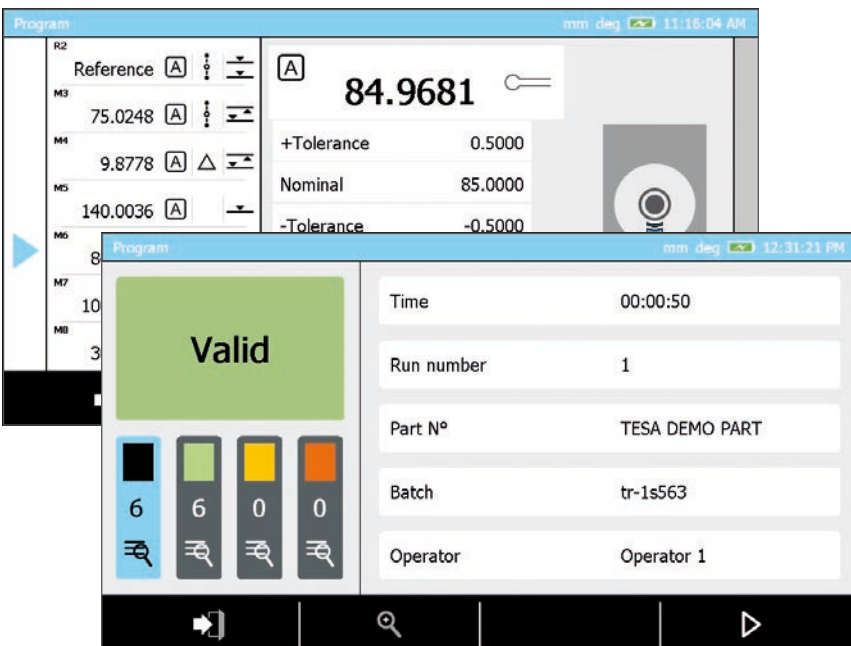

Clear results

Each part has its own tolerances. The software has been created to allow inserting easily acceptance/reject limits in the most direct possible way. Once the part is measured, the user is explicitly informed about its state.

- Precise and detailed measurement results are displayed to the user (GO/NOGO, rework,...) and managed at the same time by the data backup peripheral devices.

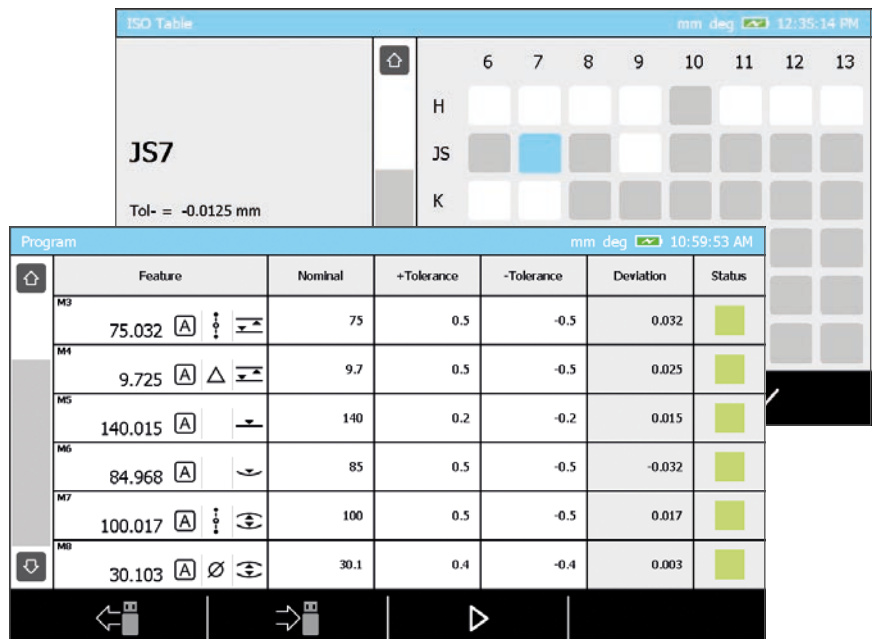



“FLEXIBLE” DATA MANAGEMENT

The TESA MICRO-HITE height gauges are designed to be flexible, its aim to provide the best data management solutions regardless of the type of user or application.



Printing

The data can be automatically sent to a printer connected to the panel.
The printer is optional and can be connected to the instrument at any time during its use.
The data can be printed automatically after each measurement or on demand of the user.



Save on USB stick

The data can be saved in a *.txt file on a memory stick. Several data formats are available (measured value, measured value and tolerances, ...).
The data can be saved automatically after each measurement or on demand of the user.



*.pdf report

After each execution of a measurement sequence a complete report in *.pdf format is created automatically or manually on the USB stick. The report can be customized (insertion of the image of the measured part, the company logo, the operator name or the batch name).



Connection to a peripheral device

It is possible to connect the instrument to a computer or any other peripheral unit via the TLC (TESA Link Connector) to receive the measuring results on it.
This connection can be achieved by cable or wireless.
The data can be sent automatically after each measurement or on demand of the user.



Direct information

Quick access to measurement information is a key element of a production line performance.
For this purpose, TESA has directly integrated the possibility to insert tolerances for the measured elements. Once the end of a measurement program is reached, the user has the possibility to visualize the detail of his results, which are directly accessible on the instrument panel.

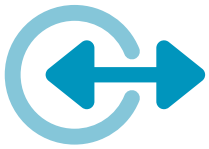

Retrieve data with ease

Most of the TESA instruments are compatible with the free TESA DATA-VIEWER software, allowing a quick and easy handling of all measurement data. The data is then automatically transferred to files in known formats such as *.xls, *.csv, or Q-DAS.

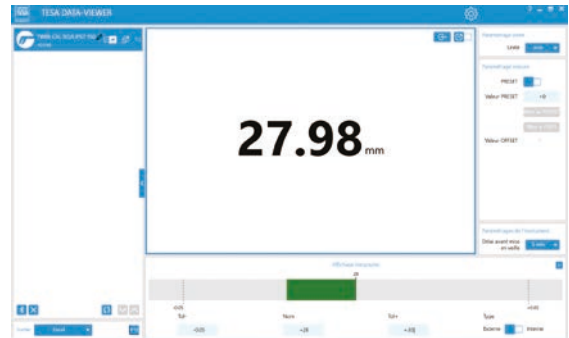

Fill out a report template in real time

With TESA DATA-DIRECT software, it is possible to measure one or more mechanical parts and to receive automatically formatted data in a report template previously prepared (Excel for example). Once a measurement has been recorded, the report is directly accessible.



The quick and easy statistical software

The SPC (Statistical Process Control) TESA STAT-EXPRESS software is the way to calculate in real time all the important characteristics during statistical analyses. Quick to learn, it manages also automatically the measuring reports.



For demanding statistics

For users with more extensive needs, Q-DAS software will be able to meet the most specific requirements:

- Control and traceability
- Automated data recovery
- Setting up dashboards
- Quality management
- Optimization of production processes
- Supplier quality monitoring

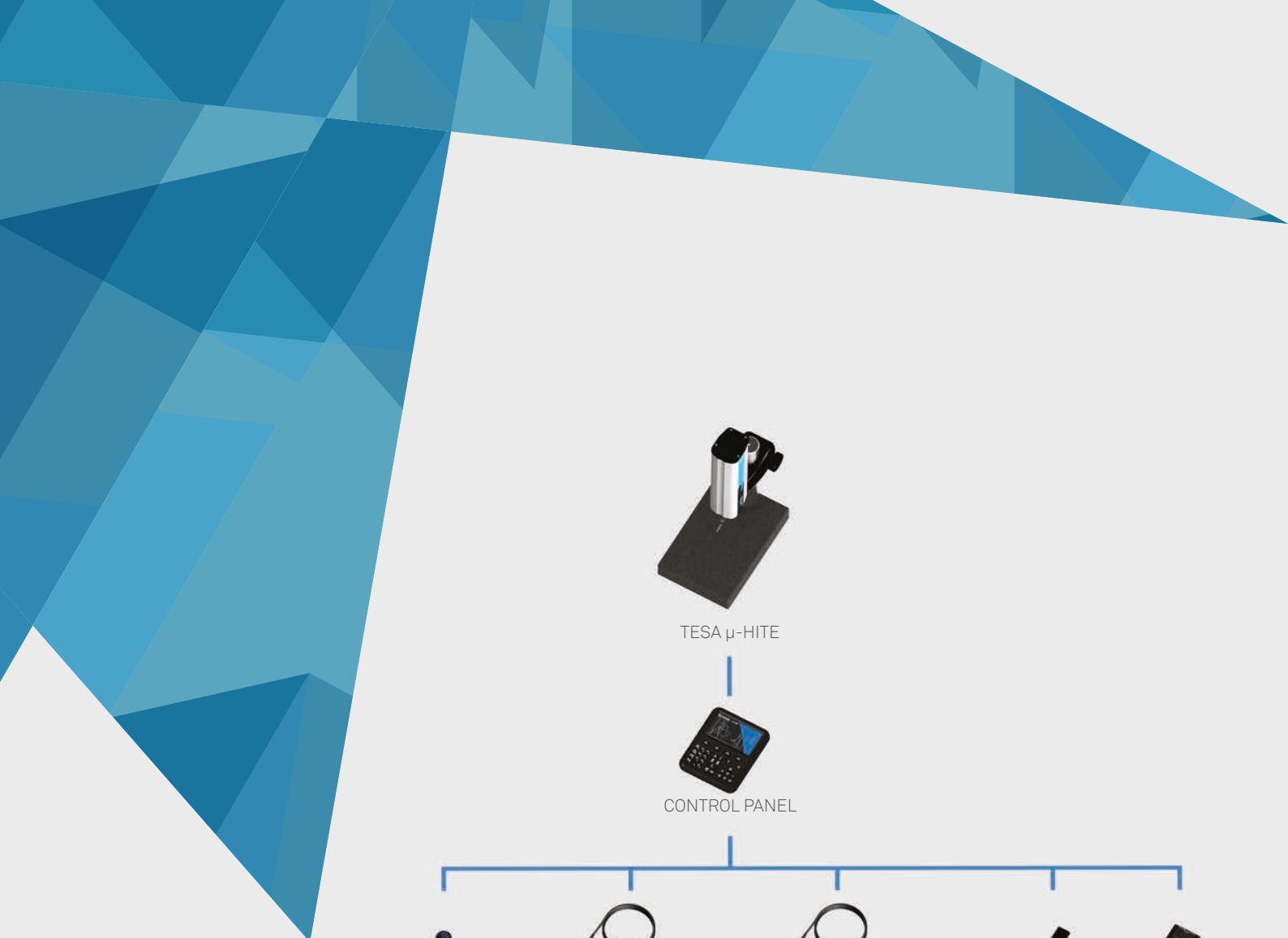

TESA μ -HITE



CONTROL PANEL



TLC-BLE
(04760183)
+
DATA-VIEWER

TLC-DIGIMATIC CABLE
(04760182)

TLC-USB CABLE
(04760181)

USB STICK

PRINTER
(00760235)



Q-DAS



DATA-DIRECT
(04981001)

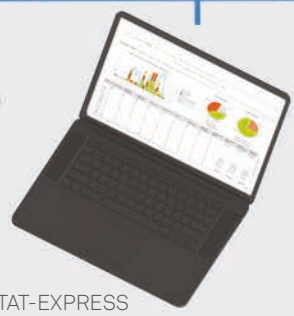

STAT-EXPRESS
(04981002)



COMPUTER

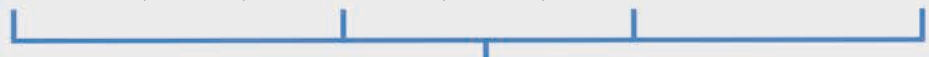

DESK PRINTER



	TESA μ-HITE	Note
	2 probing configurations	✓ Axial and offset
	Single probing	✓
	Culmination point	✓
	Double probing	✓
	Max, min, delta Parallelism, flatness	✓ Dynamic measurement
	Straightness	✓
	Angle	✓ Surfaces or cone
	Embedded calculator	✓ Customisable calculation function
	2D functions	✓
	References	A/B
	Distance	✓
	Mid-point	✓
	Tolerancing GO/NOGO report	✓ GO/NO GO report on the screen
	mm/inch conversion	✓ From control panel
	Online help	✓ Intelligent context-based help
	Preset	✓
	Learning/programming mode	✓ Save on USB stick
	Save data on USB stick	✓ In *.txt format Generation of *.pdf report
	Send data through TLC port	✓ By cable or wireless
	Print data	✓
	Screen shot	✓

		TESA μ-HITE		Retrofit kit for previous generation of μ-HITE
Part number		00730502	00730503	00730504
MAIN COMPONENTS	Motorised TESA μ-HITE probe head	✓	✓	
	Control panel	✓	✓	✓
	Granite table 200 x 300 x 50 mm		✓	
	Pole Ø 50 x 300 mm		✓	
	Probe head support		✓	
	Adaptation box	✓	✓	✓
	Panel-adaptation box cable	✓	✓	✓
	Adaptation box-probe head cable	✓	✓	✓
ACCESSORIES	Axial probe holder for M2,5 inserts	✓	✓	
	Axial probe insert, hard metal ball tip, Ø 3 mm	✓	✓	
	Offset probe insert, hard metal tip, Ø 5 mm	✓	✓	
	12,7 mm / .5 in masterpiece	✓	✓	
POWER SUPPLY	Power supply	✓	✓	✓
	EUR power cable	✓	✓	✓
	US power cable	✓	✓	✓
OTHERS	SCS certificate	✓	✓	
	1 year warranty	✓	✓	✓
	Maintenance contract	Upon request	Upon request	



If you want a different size of granite table or pole, please contact your local dealer.

TESA μ -HITE



Workshop or laboratory instrument



Motorised displacements



2 probing configurations



Adjustable trigger force



Compact turnkey system



Colour & touch screen



Included SCS certificate



1D & 2D measurement modes



Can be steered by external commands

	00730502	00730503
Measuring range [mm]	0 ÷ 100	0 ÷ 100
Max. perm. error [μ m]	Axial: 1 - offset: 2	Axial: 1 - offset: 2
Repeatability (2σ) [μ m]	Axial: 0,5 - offset: 1	Axial: 0,5 - offset: 1
Trigger force [N]	0,6 \pm 0,2 or 1,00 \pm 0,2	0,6 \pm 0,2 or 1,00 \pm 0,2
Panel [mm]	Screen: 84x152 Keyboard: backlit	Screen: 84x152 Keyboard: backlit
Resolution [mm]	0,001 / 0,0001	0,001 / 0,0001
Weight [kg]	Panel + adaptation box: 1,5 – measuring head: 2,5	Panel + adaptation box: 1,5 – measuring head: 2,5 Granite + pole + support: 16,2



EXAMPLES OF USE:

Lithium-ion batteries

One of our clients uses several μ -HITEs, in parallel, on its automated production line dedicated to the manufacture of lithium-ion batteries. The main task of our instruments is to determine the thickness, at the line output, of a multi-layer film (separator + anode + cathode) from which the heart of the batteries is created.



Ceramic parts

One of our clients uses his μ -HITE to ensure that the thickness and diameter of the ceramic seals he produces meet the required specifications.



Valve tappets

The tappet (1) is a mechanical part connecting a camshaft (2) and a valve (3). The cam presses on the plunger, which in turn presses the inlet or exhaust valve to allow the gaseous mixture to enter or leave the combustion chamber of an engine.

One of our clients uses his μ -HITEs to control the height between the face on which the cam will come to press and the face in contact with the valve stem.

The aim is to be able to classify the tappets according to this dimension in order to allow a good pairing between valves with more or less long stem and their respective tappets.

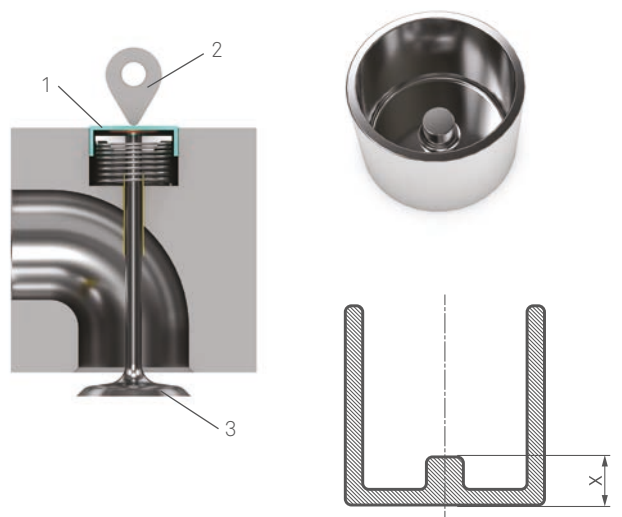

Sleeves

For one of its crimping tools, one of our clients uses his μ -HITE to determine whether the internal cone angle of a sleeve meets the expected specifications. To do this, he compares the height difference between the upper surface of the part and the height of a reference ball measured by a flat probe.

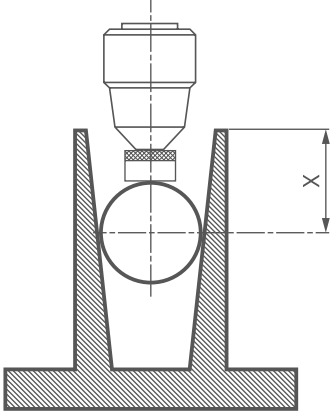

Watch cases

One of our clients uses his μ -HITE to check that the dimensions of the watch cases he receives are correctly manufactured to receive the various components he wants to place on them.

Hydraulic parts

One of our clients uses his μ -HITE to control the heights of different parts he produces. The difficulty of certain parts lies in the accessibility of the zone to be measured. That's why he uses a TESA μ -HITE rod-shaped accessory so he can insert it deep into the part without touching it.



Pill moulds

One of our clients uses his μ -HITE to control the shape of his moulds after prolonged use.

Therefore, he measures both diameters on each side of the mould to confirm that the system is still meeting the dimensional expectations.

ACCESSORIES

The TESA height gauges are compatible with a wide range of accessories which allowing the instrument to be customised to meet your real needs.

Probe holders

Probe holder for axial measurement 1	00760194	For threaded probe inserts M1,4
Probe holder for axial measurement 2	00760195	For threaded probe inserts M2,5
Probe holder for axial measurement 3	00760196	For threaded probe inserts M3
Probe holder for offset measurement 1	00760187	For rod (0° and 8°)
Probe holder for offset measurement 2	00760198	With a mounting bore \varnothing 4 mm
Probe holder for offset measurement 3	00760199	2xM1,4 + 2xM3, use in conjunction with 00760198
Probe holder for offset measurement 4	00760255	2xM1,4 + 3xM2,5

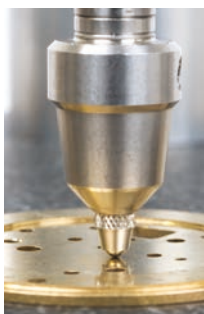
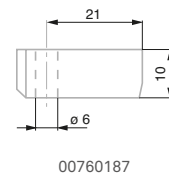
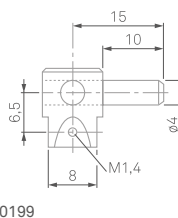
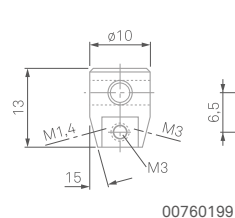
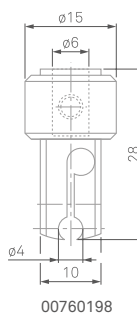
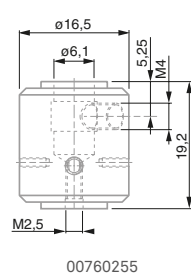
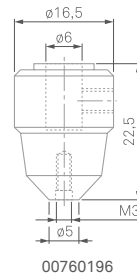
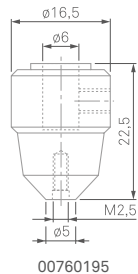
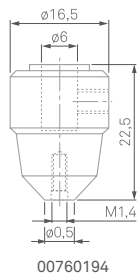

Cone-shaped probe

Probe insert \varnothing 8mm	00760183	Hardened steel, M3 thread
--------------------------------	----------	---------------------------

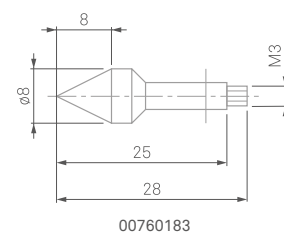
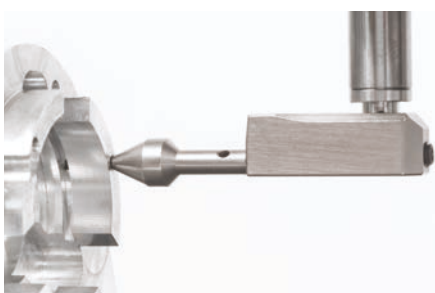

Ball probes

Probe insert Ø 5 mm	00760197	Carbide ball tip
Probe insert Ø 5 mm	00760200	Carbide ball tip, in conjunction with probe holder 00760198
Probe insert Ø 3 mm	00760201	Carbide ball tip, in conjunction with probe holder 00760198
Probe insert Ø 0,9 mm	00760180	Steel tip, hardened, M3 thread
Probe insert Ø 1,9 mm	00760181	Steel tip, hardened, M3 thread
Probe insert Ø 2,9 mm	00760182	Steel tip, hardened, M3 thread
Probe insert Ø 1 mm	01860201	Carbide ball tip, M1,4 thread
Probe insert Ø 2 mm	01860202	Carbide ball tip, M1,4 thread
Probe insert Ø 3 mm	01860203	Carbide ball tip, M1,4 thread
Probe insert Ø 1 mm	01860211	Carbide ball tip, M1,4 thread
Probe insert Ø 2 mm	01860212	Carbide ball tip, M1,4 thread
Probe insert Ø 3 mm	01860213	Carbide ball tip, M1,4 thread
Probe insert Ø 1 mm	03560051	Carbide ball tip, M2,5 thread
Probe insert Ø 2 mm	03560052	Carbide ball tip, M2,5 thread
Probe insert Ø 3 mm	03560053	Carbide ball tip, M2,5 thread
Probe insert Ø 4 mm	03560054	Carbide ball tip, M2,5 thread
Probe insert Ø 5 mm	03560055	Carbide ball tip, M2,5 thread
Probe insert Ø 6 mm	03560056	Carbide ball tip, M2,5 thread
Probe insert Ø 7 mm	03560057	Carbide ball tip, M2,5 thread
Probe insert Ø 8 mm	03560058	Carbide ball tip, M2,5 thread



Other ball probes are also available. Please refer to the general catalogue or contact your local dealer.

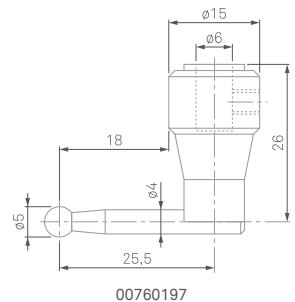
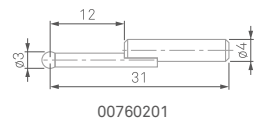
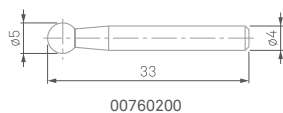
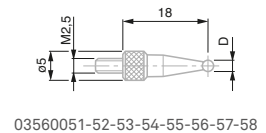
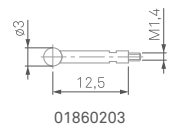
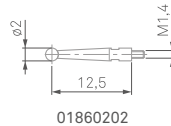
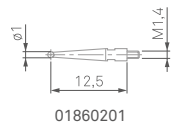
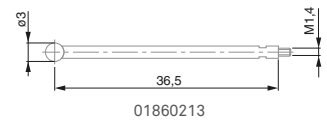
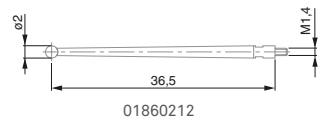
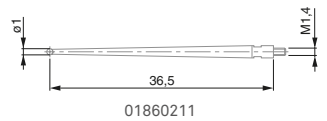
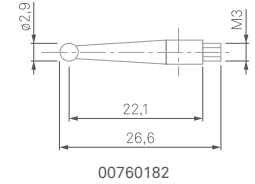
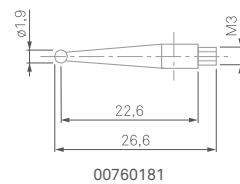
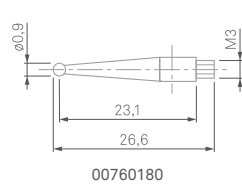

Spherical measuring inserts

Probe insert, R = 1 mm	03510204	Carbide ball probe, M2 thread
Probe insert, R = 5 mm	03510103	Carbide ball probe, M2 thread
Probe insert, R = 5 mm	03510202	Carbide ball probe, L = 16 mm, M2 thread
Probe insert, R = 5 mm	03510203	Carbide ball probe, L = 26 mm, M2 thread
Probe insert, R = 0,5 mm	03560035	Steel probe, L = 5 mm, M2,5 thread
Probe insert, R = 0,5 mm	03560036	Steel probe, L = 10 mm, M2,5 thread
Probe insert, R = 0,5 mm	03560037	Steel probe, L = 15 mm, M2,5 thread
Probe insert, R = 0,5 mm	03560038	Steel probe, L = 20 mm, M2,5 thread
Probe insert, R = 0,5 mm	03560039	Steel probe, L = 30 mm, M2,5 thread
Probe insert, R = 0,5 mm	03560040	Steel probe, L = 40 mm, M2,5 thread
Probe insert, R = 1,5 mm	03510001	Steel probe, M2,5 thread
Probe insert, R = 1,5 mm	03510002	Carbide ball probe, M2,5 thread
Probe insert, R = 1,5 mm	03560001	Sapphire probe, M2,5 thread
Measuring insert with 4 interchangeable pins	03510201	Steel probe, L = 16/26/36/46 mm, M2,5 thread
Probe insert, short, Ø 3 mm	03560007	Carbide ball probe, M2,5 thread
Probe insert, long, Ø 3 mm	03560019	Steel probe, M2,5 thread
Probe insert, long, Ø 3 mm	03560020	Carbide ball probe, M2,5 thread
Probe insert, long, Ø 3 mm	03560021	Ruby probe, M2,5 thread
Probe insert, R = 5 mm	03510101	Steel probe, M2,5 thread
Probe insert, R = 5 mm	03510102	Carbide ball probe, M2,5 thread
Probe insert, R = 16 mm	03560017	Steel probe, M2,5 thread
Probe insert, R = 16 mm	03560018	Carbide ball probe, M2,5 thread

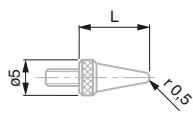

03560035-36-37-38-39-40

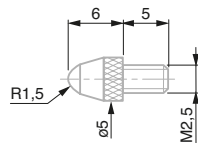

03510001-02 | 03560001

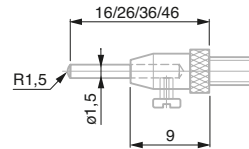

03510201

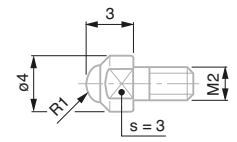

03510204

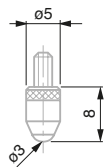

03560019-20-21

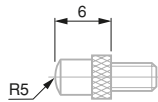

03510101-102

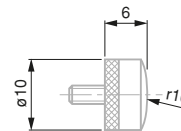

03560017-18

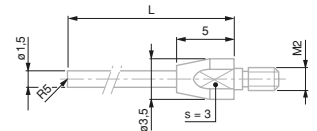

03510202-203

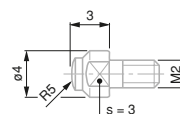

03510103

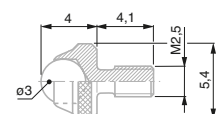

03560007

Flat face probe

Insert with adjustable parallelism, Ø 2,5 mm	03510902	Carbide ball probe, M2,5 thread Counter-nut for radial alignment
Probe insert, Ø 1,5 mm	03560008	Steel probe, interchangeable pin, M2,5 thread
Probe insert, Ø 1,5 mm	03560009	Carbide ball probe, interchangeable pin, M2,5 thread
Probe insert, Ø 2 mm	03560026	Steel probe, L = 5 mm, L1 = 2,8 mm, M2,5 thread
Probe insert, Ø 2 mm	03560027	Steel probe, L = 10 mm, L1 = 7,8 mm, M2,5 thread
Probe insert, Ø 2 mm	03560028	Steel probe, L = 15 mm, L1 = 12,8 mm, M2,5 thread
Probe insert, Ø 2 mm	03560029	Steel probe, L = 20 mm, L1 = 17,8 mm, M2,5 thread
Probe insert, Ø 2,5 mm	03510801	Steel probe, M2,5 thread
Probe insert, Ø 2,5 mm	03510802	Carbide ball probe, M2,5 thread
Probe insert, Ø 3,4 mm	03560022	Steel probe, M2,5 thread
Probe insert, Ø 3,4 mm	03560023	Carbide ball probe, M2,5 thread
Probe insert, Ø 5 mm	03560012	Steel probe, M2,5 thread
Probe insert, Ø 5 mm	03560013	Carbide ball probe, M2,5 thread
Probe insert, Ø 10 mm	03560014	Steel probe, M2,5 thread
Probe insert, Ø 10 mm	03560015	Carbide ball probe, M2,5 thread
Probe insert, Ø 20 mm	03560016	Steel probe, M2,5 thread

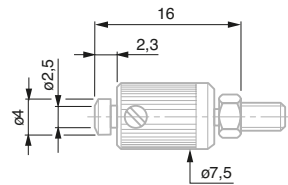

03510902

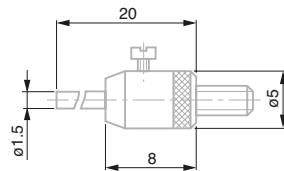

03560008-09

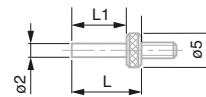

03560026-27-28-29

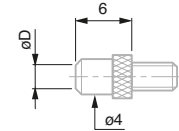

03510801-02 | 03560022-23

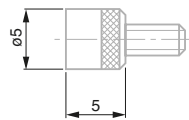

03560012-13

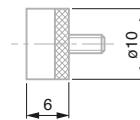

03560014-15

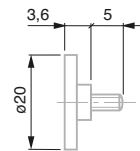

03560016

Cylindrical measuring inserts

Probe insert, Ø 2 mm	03510503	Carbide ball probe, M2 thread Counter-nut for radial alignment
Probe insert, Ø 2 mm	03510502	Carbide ball probe, M2,5 thread Counter-nut for radial alignment

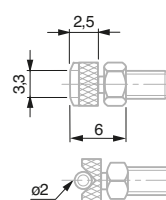

03510502

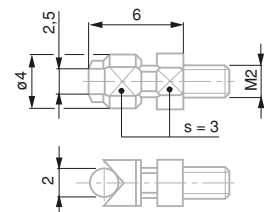

03510503

Shaft probes

The shaft probes are mainly used to measure grooves, centring shoulders, blind bores, ...

Rod, angle 8°	00760178	Hardened steel, use in conjunction with holder 00760187
Cylindrical rod	00760179	Carbide, use in conjunction with holder 00760187

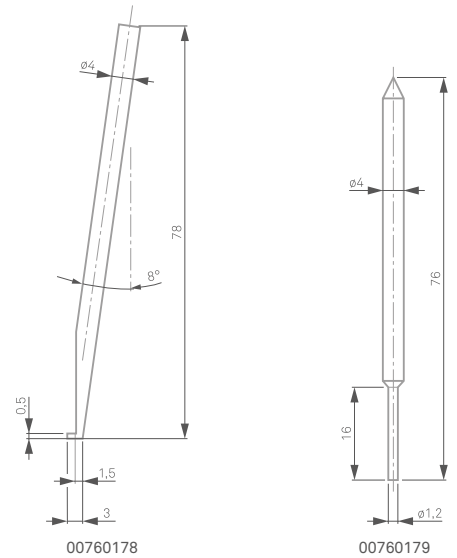

Extensions

Extension L = 10 mm	03540505	For M2 accessory, M2 thread
Extension L = 15 mm	03540506	For M2 accessory, M2 thread
Extension L = 10 mm	03560042	For M2,5 accessory, M2,5 thread
Extension L = 15 mm	03560043	For M2,5 accessory, M2,5 thread
Extension L = 20 mm	03560044	For M2,5 accessory, M2,5 thread
Extension L = 25 mm	03560045	For M2,5 accessory, M2,5 thread
Extension L = 30 mm	03560046	For M2,5 accessory, M2,5 thread
Extension L = 35 mm	03560047	For M2,5 accessory, M2,5 thread
Extension L = 40 mm	03560048	For M2,5 accessory, M2,5 thread
Extension L = 45 mm	03560049	For M2,5 accessory, M2,5 thread
Extension L = 50 mm	03560050	For M2,5 accessory, M2,5 thread
Extension L = 20 mm	00760184	For M3 accessory, M3 thread
Extension L = 20 mm	00760185	For M2,5 accessory, M3 thread

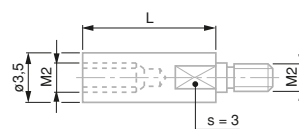

03540505-06

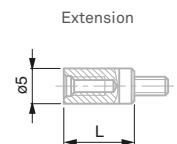

03560042-43-44-45-46-47-48-49-50

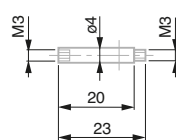

00760184

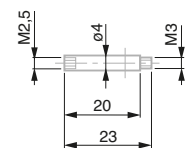

00760185

Adapter

Adapter M2,5-M2	03560092	For M2 accessory, M2,5 thread
Adapter M3-M2,5	03560065	For M2,5 accessory, M3 thread

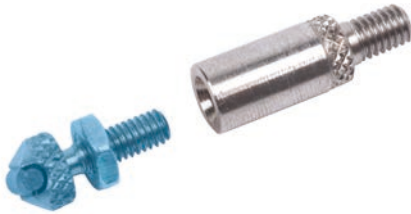

Knife-edged measuring inserts

Insert 2 mm	03560031	Steel, L = 5 mm, M2,5 thread - Counter-nut for radial alignment
Insert 2 mm	03560032	Steel, L = 10 mm, M2,5 thread - Counter-nut for radial alignment
Insert 2 mm	03560033	Steel, L = 15 mm, M2,5 thread - Counter-nut for radial alignment
Insert 2 mm	03560034	Steel, L = 20 mm, M2,5 thread - Counter-nut for radial alignment
Insert 3,4 mm	03560024	Steel, L = 8 mm, M2,5 thread - Counter-nut for radial alignment
Insert 3,4 mm	03560025	Carbide, L = 8 mm, M2,5 thread - Counter-nut for radial alignment

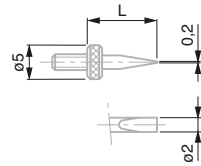

03560031-32-33-34

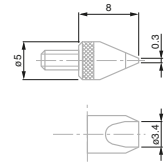

03560024 -25

Kit

Set of inserts for TESA μ-HITE consisting of:	00760186	
Probe holder for offset measurement	00760187	For rod (0° and 8°)
Rod, angled through 8°	00760178	Hardened steel
Cylindrical rod	00760179	Carbide
Ball probe insert, Ø 0,9 mm	00760180	Steel tip, hardened, M3 thread
Ball probe insert, Ø 1,9 mm	00760181	Steel tip, hardened, M3 thread
Ball probe insert, Ø 2,9 mm	00760182	Steel tip, hardened, M3 thread
Cone-shaped probe insert, Ø 8 mm	00760183	Hardened steel, M3 thread
Extension 20 mm	00760184	For M3 insert, M3 thread
Extension 20 mm	00760185	For M2,5 insert, M3 thread

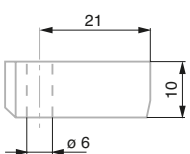

00760187

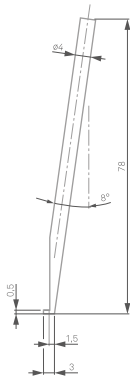

00760178

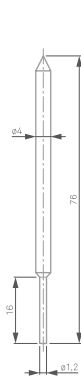

00760179

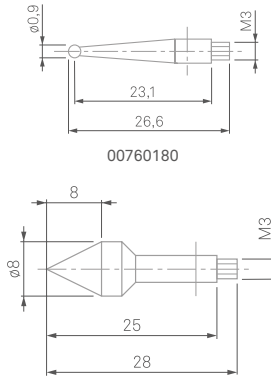

00760180

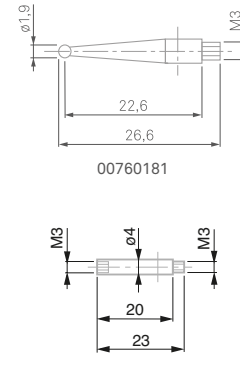

00760181

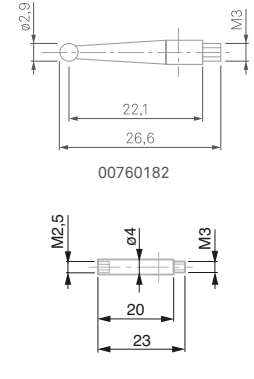

00760182

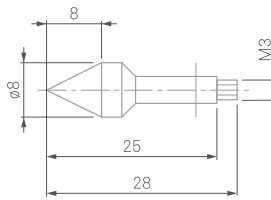

00760183

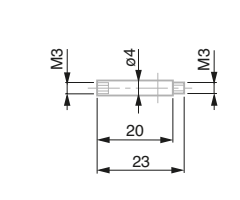

00760184

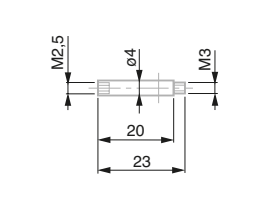

00760185

OTHER ACCESSORIES

DATA MANAGEMENT	USB printer	00760235	-
	Thermal paper for USB Printer	00760250	Pack of 4 rolls
	TESA DATA-DIRECT software	04981001	For data formatting
	TESA STAT-EXPRESS software	04981002	SPC software
	Q-DAS software (qs-STAT, ...)	-	Please contact your local dealer
	TLC-USB cable	04760181	-
	TLC-DIGIMATIC cable	04760182	-
	TESA TLC-BLE emitter (Bluetooth®)	04760184	-
	USB dongle receiver + 1,5 m cable	04760185	For use with 04760184
	TESA TLC-BLE starter kit	04760183	= 04760184 + 04760185
POWER SUPPLY	Charger	00760251	-
	Charger cable	04761055	For Europe
	Charger cable	04761056	For USA
OTHERS	Control panel	00760234	-
	Reference gauge	00760253	12,7 mm/5in
	Hand switch	04768000	For manual release, cable L = 1,8 m
	Foot switch	04768001	For a foot release, cable L = 1,8 m
	Cleaning liquid	00760249	For granite table

THE TESA SERVICE, OUR PRIORITY

For TESA, customer care is essential. To satisfy the most demanding metrological expectations of our clients and to help them find solutions is our daily challenge.



Calibration

To preserve the accuracy of measurement of your tools, TESA controls and calibrates your equipment and delivers a SCS accreditation (Swiss Calibration Service) or a TESA measuring report.



Repairs

Your height gauge needs to be repaired? TESA proposes quick solutions to repair, exchange and rent, if your equipment is under warranty or not.



Support

A product support and technical support are available for TESA equipment.



Training

A whole range of courses has been designed to meet your needs: user training during the installation, product training at TESA headquarters as well as on-site and customised trainings.



Maintenance

Work with peace of mind thanks to the preventive TESA maintenance contract to extend the life of your equipment and to preserve their precision.



Customization of the measuring inserts

For any requirements of specific measures, TESA proposes to customise your measuring insert according to your wishes.



HEXAGON

MANUFACTURING INTELLIGENCE

Hexagon Manufacturing Intelligence helps industrial manufacturers develop the disruptive technologies of today and the life-changing products of tomorrow. As a leading metrology and manufacturing solution specialist, our expertise in sensing, thinking and acting – the collection, analysis and active use of measurement data – gives our customers the confidence to increase production speed and accelerate productivity while enhancing product quality.

Through a network of local service centres, production facilities and commercial operations across five continents, we are shaping smart change in manufacturing to build a world where quality drives productivity. For more information, visit HexagonMI.com.

Hexagon Manufacturing Intelligence is part of Hexagon (Nasdaq Stockholm: HEXA B; hexagon.com), a leading global provider of information technologies that drive quality and productivity across geospatial and industrial enterprise applications.

-  COORDINATE MEASURING MACHINES
-  3D LASER SCANNING
-  SENSORS
-  PORTABLE MEASURING ARMS
-  SERVICES
-  LASER TRACKERS & STATIONS
-  MULTISENSOR & OPTICAL SYSTEMS
-  WHITE LIGHT SCANNERS
-  METROLOGY SOFTWARE SOLUTIONS
-  CAD / CAM
-  STATISTICAL PROCESS CONTROL
-  AUTOMATED APPLICATIONS
-  MICROMETERS, CALIPERS, HEIGHT GAGES, ETC...
-  DESIGN AND COSTING SOFTWARE



Established in 1941 and headquartered in Renens, Switzerland, TESA SA manufactures and markets precision measuring instruments that stand for quality, reliability and longevity.

For more than 75 years, TESA has distinguished itself in the market through its excellent products, its unique expertise in micromechanics and precision machining as well as its proven experience in dimensional metrology.

The TESA brand is the global market leader in the field of height gauges and a pioneer thanks to its wide range of instruments, including callipers, micrometers, dial gauges,

lever-type dial test indicators and inductive probes. TESA is a true benchmark for the inspection of incoming goods, as well as for production workshops and quality assurance laboratories.

Through its worldwide distribution network the company focuses on the mechanical engineering, micromechanical, automotive, aerospace, watchmaking and medical industries.

In 2001, TESA became part of Hexagon, a leading global provider of information technologies.

TESAtechnology.com