

SALES@WILLRICH.COM  
Ph 866-945-5742

Mitutoyo

MeasurLink<sup>®</sup> ENABLED  
Data Management Software by Mitutoyo



# SPRING PROMO 2019

PRECISION TOOLS & INSTRUMENTS

Effective May 1 through July 31, 2019

SPRING PROMO 2019



**NEW**  
Products

d2

# Data Collection – Store. Send. Print.



## Dear Valued Customers,

I want to take a moment to express my sincere appreciation for your continued support and commitment to Mitutoyo products and services.

Inside the pages of the 2019 spring promotion, you will find a lot of great deals on a variety of Mitutoyo tools and instruments including calipers, micrometers, indicators, height gages, microscopes and profile projectors. Prices are effective May 1, 2019 – July 31, 2019.

You can find all of the latest promotions, products and events on our website, [www.mitutoyo.com](http://www.mitutoyo.com).

Thank you for trusting us with your metrology needs.

Sincerely,

*Matthew B. Dye*

**Matt Dye**  
President, Mitutoyo America Corporation

Mitutoyo products are sold only through authorized distributors. To find an authorized Mitutoyo distributor near you, visit: [www.mitutoyo.com/distributor-locator/](http://www.mitutoyo.com/distributor-locator/)



**The DP-1VA collects data from a Digimatic gage which can be stored, exported to software or printed.**

### Data Logger:

- Data can be stored internally, printed and/or sent to a PC as it is measured or after all data has been collected.
- Up to 1,000 measurements can be stored.

### Timer:

- Data collection can be triggered by a timer function.
- The DP-1VA can collect data unattended to measure changes over time.

### Tolerance and SPC:

- Tolerances can be set in the unit, and statistics can be calculated and printed directly from the DP-1VA.
- No additional software is required.

### Features:

- d2 compatible
- A gage with SPC output is connected to the DP-1VA with an SPC cable.
- The data for each part measured is printed, saved or sent directly to a PC through a USB cable.
- This data can be triggered by the button on the gage, cable or the DP-1VA. An optional footswitch can also be used.



264-505A



"d2" is the name for Mitutoyo Digimatic output compatible with up to 8 digits of I/O data.

Order No.	Model	List	Promo
264-505A	DP-1VA	\$514.00	\$488.30

Order No.	264-505A
Data input	Digimatic, Digimatic 2, RS-232C input (for KA Counter Only)
Printing method	Thermal Line Printer
Character specifications	Total dot number: 384 dots/line Dot size: 8 dots/mm Normal font: 24 x 16 dots Large font: 36 x 24 dots
Print speed	0.8 s/line when using AC adapter
Print capacity	7,000 lines/roll with Large font 10,000 lines/roll with Normal font
Print data	Measuring data, go/±no go, number of data, maximum minimum value, range, average, standard deviation, number of defective, function defective, process capability index, histogram, D-chart, control chart generation for X-bar and central limit data, data and time
Printer paper	High durability thermal paper. (one roll included) Width: 58mm. Roll length: 48m
Power supply	100 V 50/60 Hz AC adapter (6 V, 2 A) AA alkaline batteries x4 (not included)
Battery life	About 10,000 lines at 20 C
Data processing capability	Mode 0: 100,000 data entries Mode 1: 9,999 data entries Mode 3: sample size 10 x subgroup 9,999 = Total number of data entries: 99,990
Tolerance judgement	5 sets
Logging of measurement data	Max 1,000 points
Timer input	0.25 s, 1 s, 5 s, 30 s, 1 min, 30 min, 60 min
Data Output	USB Output RS-232C output at TTL level Tolerance judgment result output (-NG, GO, +NG)
Clock precision	+/-2 min max/month
Internal battery life	10 years
Operating temperature range	0 C to 45 C with AC adapter 10 C to 45 C with batteries
External Dimensions	94mm x 201mm x 75mm



USB connection allows collected data to be easily transferred from the DP-1VA to the PC. The output is HID or VCP so data can be sent directly to Excel or data collection software such as IT-Pak or MeasurLink.

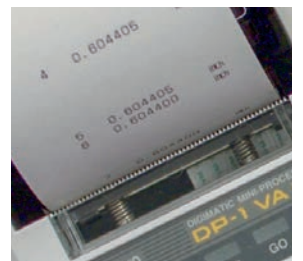

Digimatic 2 function allows the high resolution of the gage to be output in its entirety in metric or inch.



DATA MANAGEMENT  
SYSTEMS LITERATURE

## Quickmikes

The new Quickmike series still boasts the super-fast spindle feed rate that's **20x faster** than standard micrometers, Absolute encoder, increased measuring ranges. New features include:

- > IP65 protection – can be used around cutting fluids
- > MIN Hold – the minimum measurement can be held on the display for more repeatable and accurate measurements
- > Larger LCD – 33% larger, 10mm character height
- > Function lock – prevents accidental changes
- > 5 year battery life – more operating time, less downtime looking for and replacing batteries



293-676-20



293-677-20



**MeasurLink<sup>2</sup> ENABLED**  
Data Management Software by Mitutoyo

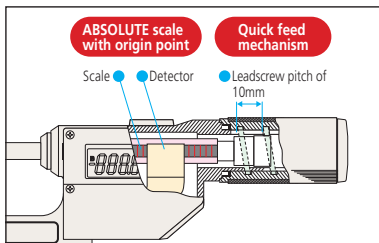

### ABSOLUTE™

The ABS (absolute) linear scale eliminates the need for origin setting at every power-on and achieves high reliability while being free from overspeed error.

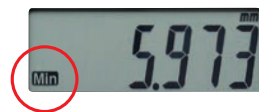
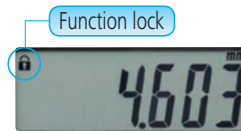

Minimum-value hold function ensures measurement value is retained

**COOLANT PROOF™ IP65**

Order No.	Range	Resolution	Accuracy	Flatness	Parallelism	List	Promo
293-676-20	0 - 1.2"	.00005"/0.001mm	±0.0001"	0.000012"	0.00008"	\$611.00	<b>\$580.45</b>
293-677-20	1 - 2.2"	.00005"/0.001mm	±0.0001"	0.000012"	0.00008"	\$667.00	<b>\$633.65</b>

SPC cable with data switch – 1m: **05CZA662** 2m: **05CZA663**

## MDC Micrometer

- > New electromagnetic ABSOLUTE sensor - Improved resistance to environmental conditions such as dirt, oil and water, which can cause false readings.
- > New ratchet thimble on select models improves one-hand operability.
- > New anti-slip finish for improved grip while taking measurements.
- > Long battery life – 2.4 years under normal operation.
- > Function-lock system prevents accidental setting changes.
- > Certificate of inspection provided.



293-348-30



www.mitutoyo.com/MDC  
VIDEO DEMO

**COOLANT PROOF™**

Order No.	Range	Resolution	Remarks	List	Promo
293-340-30	0-1"/0-25.4mm	.00005"/0.001mm	Ratchet Stop	\$193.00	<b>\$183.35</b>
293-344-30	0-1"/0-25.4mm	.00005"/0.001mm	Ratchet Thimble	\$193.00	<b>\$183.35</b>
293-348-30	0-1"/0-25.4mm	.00005"/0.001mm	Friction Thimble	\$193.00	<b>\$183.35</b>
293-349-30	0-1"/0-25.4mm	.0001"/0.001mm	Ratchet Thimble	\$193.00	<b>\$183.35</b>
293-345-30	1-2"/25.4-50.8mm	.00005"/0.001mm	Ratchet Thimble w/Standard	\$250.00	<b>\$237.50</b>



www.mitutoyo.com



Purchase the world's first 5μinch /0.1μm resolution micrometer and receive a USB input tool and cable (\$280 value)

Using precision digital measuring tools together with a USB input tool improves both measurement results and data reliability. The latest version of digimatic output, d2, allows output to a resolution of 1 millionths of an inch. The high-accuracy MDH with 5 millionths resolution can be output in its entirety in both inch and metric. Resulting data can be input directly to Microsoft® Excel, MeasurLink® or other SPC programs.

To receive this special offer, use promo code: **PROMO026**.

Part #	Description	List Price
<b>PROMO026</b>	Package: MDH Mic, SPC Cable, USB Input Tool	<b>\$1,680.00</b>
<b>293-130-10</b>	MDH Micrometer with high accuracy, high resolution output	\$1,680.00
<b>05CZA662</b>	SPC CONNECTING CABLE (1M)	\$83.80
<b>264-016-10</b>	USB INPUT TOOL	\$197.00



High Accuracy, High Resolution MDH Micrometer with new d2 output

- > Enabling .000005"/0.0001mm resolution measurement, this micrometer is ideal for those who need to make highly accurate measurements with a handheld tool.
- > The ABS (absolute) rotary sensor eliminates the need to perform origin setting each time the power is turned on, allowing you to start measuring right away. With no possibility of overspeed errors, the high-accuracy digimatic micrometer delivers a higher level of reliability.
- > Certificate of inspection provided.



Model	Display	Output	Format
Standard Micrometer	.01235	.01235	Digimatic
MDH Micrometer w/d2	.012345	.012345	Digimatic d2

Specifications

Order No.	Range	Resolution	Accuracy
<b>293-130-10</b>	0 - 1" / 0 - 25.4mm	.000005"/.00002" 0.0001mm/0.0005mm (switchable)	±.00002"

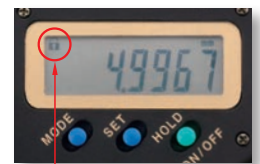

Function lock



**You Tube**

Watch our videos on Specialty Calipers & Micrometers on our YouTube channel:  
<http://www.mitutoyo.com/ytplaylist>

## Spline Micrometer

- > The anvil and spindle have a small diameter for measuring splined shafts, slots and keyways.
- > With SPC output
- > With a standard bar except 0-1"
- > Resolution: .00005"/0.001mm

**MeasurLink** ENABLED  
Data Management Software by Mitutoyo

**IP65** **SPC**



331-362-30



Digital

Order No.	Range	Accuracy	Contacts	List	Promo
331-361-30	0 - 1" / 0 - 25.4mm	±.0001"	Ø.079"	\$484.00	<b>\$459.80</b>
331-352-30	1 - 2" / 25.4-50.8mm	±.0001"	Ø.118"	\$543.00	<b>\$515.85</b>
331-362-30		±.0001"	Ø.079"	\$543.00	<b>\$515.85</b>
331-353-30	2 - 3" / 50.8-76.2mm	±.0001"	Ø.118"	\$565.00	<b>\$536.75</b>

SPC cable with data switch - 1m: **05CZA662** 2m: **05CZA663**

## Outside Micrometer with Interchangeable Anvils

- > Large range micrometers have an oversize frame and multiple anvils to allow a single micrometer to be used over a 6" range. This reduces tool cost for infrequently measured ranges.
- > Wide measuring range with interchangeable anvils.
- > Supplied with zero-setting standards bar for each range.



**MeasurLink** ENABLED  
Data Management Software by Mitutoyo



**IP65** **SPC**

Order No.	Range	Resolution	List	Promo
340-351-30	0-6" / 0-152.4mm	.00005" / 0.001mm	\$754.00	<b>\$716.30</b>
340-352-30	6-12" / 152.4 - 304.8mm	.0001" / 0.001mm	\$927.00	<b>\$880.65</b>
340-720*	12-18" / 304.8 - 457.2mm	.0001" / 0.001mm	\$1,160.00	<b>\$1,102.00</b>
340-721*	18-24" / 457.2 - 609.6mm	.0001" / 0.001mm	\$1,320.00	<b>\$1,254.00</b>
340-722*	24-30" / 609.6 - 762.0mm	.0001" / 0.001mm	\$1,460.00	<b>\$1,387.00</b>
340-723*	30-36" / 762.0 - 914.4mm	.0001" / 0.001mm	\$1,550.00	<b>\$1,472.50</b>

SPC cable with data switch - 1m: **05CZA662** 2m: **05CZA663**

\* 1m: **959149** 2m: **959150**

## Point Micrometer

- > Pointed spindle and anvil for measuring the web thickness of drills, small grooves, keyways and other hard-to-reach dimensions.
- > The measuring points have approximately 0.3mm / .012" radius.
- > With a standard bar except 0 - 1"
- > Resolution: .00005"/0.001mm (digital models)
- > With SPC output.
- > With carbide tips

**MeasurLink** ENABLED  
Data Management Software by Mitutoyo

**IP65** **SPC**



342-361-30



Digital

Order No.	Range	Accuracy	Point	List	Promo
342-361-30	0 - 1" / 0 - 25.4mm	±.0001"	30°	\$476.00	<b>\$452.20</b>
342-362-30	1" - 2" / 25.4 - 50.8mm	±.0001"	30°	\$519.00	<b>\$493.05</b>
342-363-30	2" - 3" / 50.8 - 76.2mm	±.0001"	30°	\$553.00	<b>\$525.35</b>
342-364-30	3" - 4" / 76.2 - 101.6mm	±.00015"	30°	\$588.00	<b>\$558.60</b>

SPC cable with data switch - 1m: **05CZA662** 2m: **05CZA663**

## Spherical Face Micrometer

- > Designed to measure the wall thickness of various tubing.
- > Resolution: .00005" / 0.001mm
- > With SPC output.
- > With a standard bar except 0 - 1" model.
- > With digit counter.



395-371-30

**IP65** **SPC**

**MeasurLink** ENABLED  
Data Management Software by Mitutoyo

Digital model with spherical anvil

Order No.	Range	Accuracy	Min ID	List	Promo
395-371-30 <sup>S-F</sup>	0 - 1" / 0 - 25.4mm	±.0001"	D: .59"	\$422.00	<b>\$400.90</b>
395-372-30 <sup>S-F</sup>	1" - 2" / 25.4 - 50.8mm	±.0001"	D: .59"	\$448.00	<b>\$425.60</b>
395-351-30 <sup>S-F</sup>	0 - 1" / 0 - 25.4mm	±.0001"	D: .59"	\$409.00	<b>\$388.55</b>
395-352-30 <sup>S-F</sup>	1" - 2" / 25.4 - 50.8mm	±.0001"	D: .59"	\$438.00	<b>\$416.10</b>

S-F: Spherical anvil and flat spindle

S-S: Spherical anvil and spherical spindle

SPC cable with data switch - 1m: **05CZA662** 2m: **05CZA663**

## Tire Tread Depth Gage

- > Compact depth gage.
- > Enables measurement of depth of tire groove.
- > Battery life: Approx. 5 years under normal use.
- > Allows integration into statistical process control and measurement systems.
- > With SPC output.



**MeasurLink<sup>®</sup> ENABLED**  
Data Management Software by Mitutoyo



Order No.	Range	Resolution	Accuracy	List	Promo
<b>571-200-20</b>	0 - 1" / 0 - 25mm	.0005" / 0.01mm	±.001"	\$227.00	<b>\$215.65</b>

SPC cable – 1m: **05CZA624** 2m: **05CZA625**

## Digimatic Thickness Gages

- > Thickness Gages offer a quick and efficient means of inspection with their convenient grip handle, thumb trigger and spring-loaded spindle. Models with various dimensions are also available.
- > With SPC output.



Order No.	Range	Resolution	List	Promo
<b>547-400S</b>	0-.47"/0-12mm	.00005"/0.001mm	\$856.00	<b>\$813.20</b>
<b>547-500S</b>	0-.47"/0-12mm	.0005"/0.01mm	\$290.00	<b>\$275.50</b>

## Bore Gages

- > Carbide-tipped contact points for durability.
- > The dial indicator is fully protected by a rugged cover.
- > Optional extension rods can be attached for measuring deep holes.

Dedicated Bore Gage Indicators are also available



### Optional Accessories

- 953549:** 125mm / 4.92" Extension rod for 18-35mm / .7 - 1.4" models
- 953552:** 125mm / 4.92" Extension rod for 35-160mm / 1.4 - 6.5" models
- 953557:** 125mm / 4.92" Extension rod for 160-400mm / 6.5 - 16" models
- 953550:** 250mm / 9.84" Extension rod for 18-35mm / .7 - 1.4" models
- 953553:** 250mm / 9.84" Extension rod for 35-160mm / 1.4 - 6.5" models
- 952361:** 250mm / 9.84" Extension rod for 160-400mm / 6.5 - 16" models
- 953551:** 500mm / 19.69" Extension rod for 18-35mm / .7 - 1.4" models
- 953554:** 500mm / 19.69" Extension rod for 35-160mm / 1.4 - 6.5" models
- 953558:** 500mm / 19.69" Extension rod for 160-400mm / 6.5 - 16" models
- 953555:** 750mm / 29.53" Extension rod for 35-160mm / 1.4 - 6.5" models
- 953559:** 750mm / 29.53" Extension rod for 160-400mm / 6.5 - 16" models
- 953556:** 1000mm / 39.37" Extension rod for 35-160mm / 1.4 - 6.5" models
- 953560:** 1000mm / 39.37" Extension rod for 160-400mm / 6.5 - 16" models

Order No	Range	Graduation (Indicator)	Anvils	Spacers	List	Promo
<b>511-751</b>	.7 - 1.4"	.0001" (2923SB-10)	9	2	\$423.00	<b>\$380.70</b>
<b>511-752</b>	1.4 - 2.5"		6	4	\$413.00	<b>\$371.70</b>
<b>511-753</b>	2.0 - 6.0"		11 (2" sub anvil)	4	\$451.00	<b>\$405.90</b>
<b>511-754</b>	4.0 - 6.5"		13	4	\$596.00	<b>\$536.40</b>
<b>511-755</b>	6.5 - 10"		6	7	\$672.00	<b>\$604.80</b>
<b>511-756</b>	10 - 16"		5 (3" sub anvil)	7	\$799.00	<b>\$719.10</b>



511-751

Prices effective May 1 through July 31, 2019

## ABSOLUTE Coolant-Proof Calipers

- > Sealed housing is IP-67 rated, meaning it's immune to the coolants, dirt, grit and chips found in many manufacturing environments.
- > Easy to use - no need to wipe or clean the scale.
- > .0005"/0.01mm resolution with  $\pm .001$ " accuracy.
- > Automatic power-on/off.
- > Certificate of inspection provided.

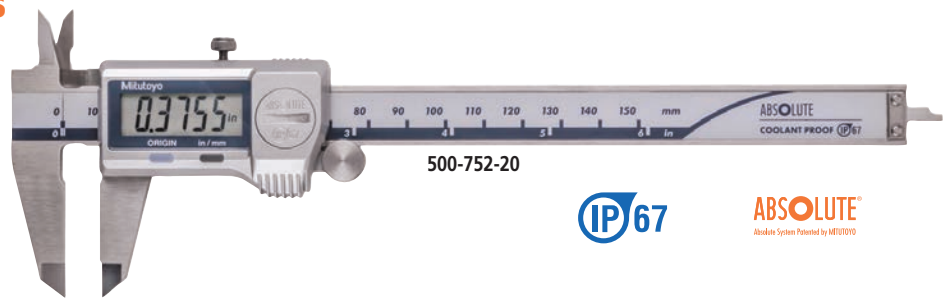

**COOLANT PROOF™**

Built-in ABS (absolute) scale means these calipers are ready to use immediately after power-on without origin resetting. It's as easy as vernier caliper measurements.

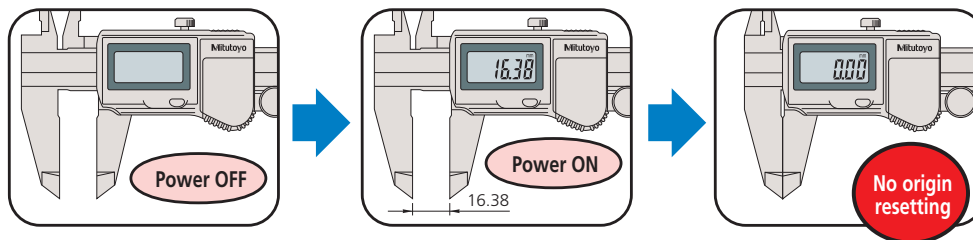

Order No.	Range	List	Promo
<b>Non-Output Style</b>			
500-752-20	0-6"/0-150mm	\$215.00	<b>\$204.25</b>
500-753-20	0-8"/0-200mm	\$288.00	<b>\$273.60</b>
500-754-10*	0-12"/0-300mm	\$499.00	<b>\$474.05</b>

\*  $\pm .0015$ " accuracy



**COOLANT PROOF™ IP67**

COOLANTPROOF is the universal term of Mitutoyo Digimatic Small Tool Instruments that are free from measurement error and physical deterioration due to routine exposure to water, cutting oil or coolant. This high performance is achieved by using encoders that are inherently immune to contamination, where exposure is inevitable, combined with comprehensive sealing techniques and extremely oil-resistant materials to guarantee a long working life under normal operating conditions.

## Digimatic Carbon Fiber Caliper



**MeasurLink™ ENABLED**  
Data Management Software by Mitutoyo

Order No.	Range	Accuracy	Resolution	List	Promo
552-312-10	0(.5")-18"	$\pm .002$ "	.0005"/0.01mm	\$975.00	<b>\$926.25</b>
552-313-10	0(.5")-24"	$\pm .002$ "	.0005"/0.01mm	\$1,090.00	<b>\$1,035.50</b>
552-314-10	0(1")-40"	$\pm .002$ "	.0005"/0.01mm	\$1,950.00	<b>\$1,852.50</b>
552-315-10	0(1")-60"	$\pm .004$ "	.0005"/0.01mm	\$2,330.00	<b>\$2,213.50</b>
552-316-10	0(1")-80"	$\pm .005$ "	.0005"/0.01mm	\$3,650.00	<b>\$3,467.50</b>

SPC cable - 1m: 05CZA624 2m: 05CZA625

- > Lightweight Digimatic Calipers that employ CFRP (Carbon Fiber Reinforced Plastics) in the beam and jaws.
- > Highly durable and easy to handle.
- > Direct readout of ID measurements from the LCD. (Offset value can be set easily by pressing the Offset key.)
- > Preset function for setting a desired starting point.
- > With SPC data output.
- > Special models available with ceramic jaws which are suitable for measuring abrasive and magnetic products.
- > Can be used in workshop conditions exposed to coolant, water, dust or oil.
- > Incorporates absolute measurement system.
- > Automatic power-on/off.



### ABSOLUTE Digimatic Calipers

- > Electromagnetic inductive sensor (AOS) improves environmental resistance against dirt, water and oil.
- > A battery life of approximately 3.5 years has been achieved under normal use through the adoption of Mitutoyo's ABSOLUTE scale.
- > The slider configuration features an ergonomic, thumb-friendly shape.
- > Can measure OD, ID, depth and steps.
- > The data output function allows integration into statistical process control and measurement systems.
- > Display character height: 9mm
- > AOS applies to 4", 6" and 8" models
- > Resolution: .0005"/0.01mm



www.mitutoyo.com/aoscd  
VIDEO DEMO

**MeasurLink** ENABLED  
Data Management Software by Mitutoyo



500-171-30

**SPC** **ABSOLUTE**  
Absolute System Powered by MITUTOYO

**ABSOLUTE AOS**  
**DIGIMATIC**  
AOS: Advanced Onsite Sensor

Order No.	Range	Remarks	List	Promo
<b>Non SPC Output Style</b>				
500-195-30	0-4"/0-100mm	.075" round depth bar	\$148.00	\$140.60
500-196-30	0-6"/0-150mm		\$161.00	\$152.95
500-197-30	0-8"/0-200mm		\$231.00	\$219.45
<b>With SPC Output Style</b>				
500-170-30	0-4"/0-100mm	.075" Round depth bar	\$177.00	\$168.15
500-171-30	0-6"/0-150mm		\$188.00	\$178.60
500-172-30	0-8"/0-200mm		\$248.00	\$235.60
500-173	0-12"/0-300mm		\$541.00	\$513.95
500-505-10	0-18"/0-450mm	without thumb roller	\$844.00	\$801.80
500-506-10	0-24"/0-600mm	without thumb roller	\$927.00	\$880.65
500-507-10	0-40"/0-1000mm	without thumb roller	\$1,790.00	\$1,700.50

SPC cable with data switch - 1m: 959149 2m: 959150

### Dial Calipers

- > Smooth sliding with high shock protection.
- > Lock screw for dial bezel and for holding the sliding jaw position.
- > Can measure OD, ID, depth and steps.
- > Models available with carbide-tipped OD and ID jaws.

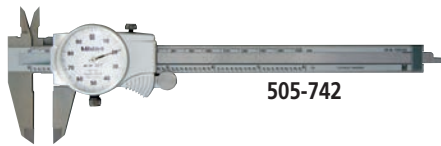

505-742

Order No.	Range	Remarks	List	Promo
505-742	6" .100"/rev.		\$125.00	\$112.50
505-738	6" .100"/rev.	carbide-tipped OD and ID jaws	\$213.00	\$191.70
505-740	6" .200"/rev.		\$114.00	\$102.60
505-743	8" .100"/rev		\$182.00	\$163.80
505-746	12" .100/rev		\$289.00	\$260.10
505-749	12" .200/rev		\$269.00	\$242.10

### Coolant-Proof Carbon Fiber Caliper with Interchangeable Jaws

- > The range of applications can be expanded by using interchangeable jaws (optional).
- > Quick and easy change of jaws due to the unique clamping mechanism. (A pair of clamping wheels is a standard accessory.)
- > Provided with preset function for setting a desired starting point, which allows direct readout of offset measurements.
- > Resolution: .0005"/0.01mm

**IP66** **SPC** **ABSOLUTE**  
Absolute System Powered by MITUTOYO

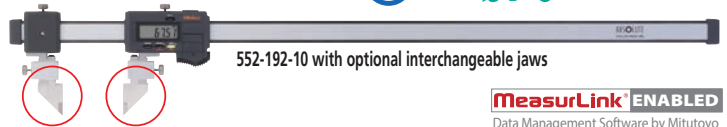

552-192-10 with optional interchangeable jaws

**MeasurLink** ENABLED  
Data Management Software by Mitutoyo

Order No.	Range	Accuracy	List	Promo
552-191-10	0 - 18" / 0 - 450mm	±.002"	\$937.00	\$890.15
552-192-10	0 - 24" / 0 - 600mm	±.002"	\$968.00	\$919.60
552-194-10	0 - 60" / 0 - 1500mm	±.004"	\$2,520.00	\$2,394.00
552-195-10	0 - 80" / 0 - 2000mm	±.005"	\$3,530.00	\$3,353.50

SPC cable with data switch - 1m: 05CZA624 2m: 05CZA625

### Interchangeable Jaws (optional)

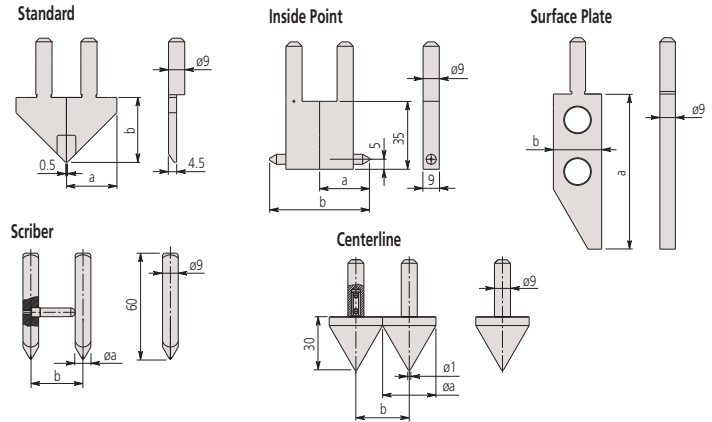

Order No.	Components	a	b	List	Promo
<b>Standard</b>					
07CZA056	Right (07CAA044), Left (07CAA045)	28mm (1.1")	30mm (1.2")	\$308.00	\$292.60
<b>Inside Point</b>					
07CZA058	07CZA041 x 2pcs.	25mm	50mm	\$317.00	\$301.15
07CZA059	07CZA048 x 2pcs.	1"	2"	\$342.00	\$324.90
<b>Scriber</b>					
07CZA055	Right (07CZA042), Left (07CZA043)	8mm	30mm	\$335.00	\$318.25
07CZA061	Right (07CZA042), Left (07CZA049)	.31"	1.2"	\$342.00	\$324.90
<b>Surface Plate</b>					
07CZA044		3.5" / 90mm	1.1" / 28mm	\$267.00	\$253.65
<b>Centerline</b>					
07CZA057	07CZA039 x 2pcs.	30mm	30mm	\$342.00	\$324.90
07CZA060	07CZA047 x 2pcs.	1.2"	1.2"	\$317.00	\$301.15



## Offset Caliper

- > Main scale jaw can slide up and down to facilitate measurement of stepped sections. (Hard-to-reach dimensions such as A, B, C can be accurately measured.)
- > With depth bar.
- > With SPC data output.

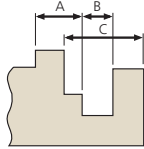

573-701-20

Order No.	Range	Accuracy	Resolution	List	Promo
573-701-20	0 - 6" / 0 - 150mm	±.001"	.0005" / 0.01mm	\$478.00	<b>\$454.10</b>
573-702-20	0 - 8" / 0 - 200mm	±.001"	.0005" / 0.01mm	\$548.00	<b>\$520.60</b>
573-704	0 - 12" / 0 - 300mm	±.0015"	.0005" / 0.01mm	\$735.00	<b>\$698.25</b>

SPC cable with data switch - 1m: **05CZA624** 2m: **05CZA625**

## Point Caliper

- > Narrow tip jaws fit into very small grooves and tracks, making many previously difficult outside measurements easier to obtain.
- > With depth bar.
- > With SPC data output.

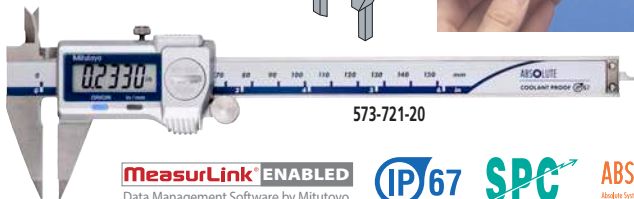
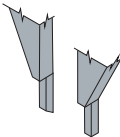

573-721-20

Order No.	Range	Accuracy	Resolution	List	Promo
573-721-20	0 - 6" / 0 - 150mm	±.001"	.0005" / 0.01mm	\$419.00	<b>\$398.05</b>
573-725-20*	0 - 6" / 0 - 150mm	±.001"	.0005" / 0.01mm	\$520.00	<b>\$494.00</b>

\* Extended tips

SPC cable with data switch - 1m: **05CZA624** 2m: **05CZA625**

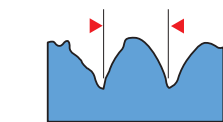

Random point-to-point dimensions

## Digimatic Caliper with Nib-Style Jaws

- > The rounded faces of the jaws are ideal for accurate ID (inside diameter) measurement.
- > Incorporates an Absolute measurement system. No need to reset the origin after switching on.
- > ID measurement value: displayed value + (a compensation value displayed on the main unit). OFFSET switch allows to input a compensation value so that the measurement value can be read directly
- > With SPC output.

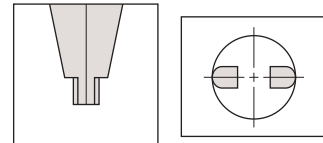

Round surface of jaws for accurate ID measurement.

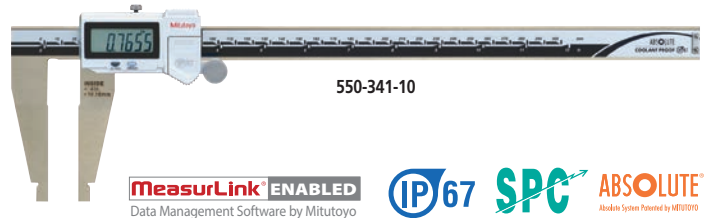

550-341-10

Order No.	Range*	Accuracy	Resolution	List	Promo
550-311-20	0 (.4") - 8" / 0 (10) - 200mm	±.001"	.0005" / 0.01mm	\$541.00	<b>\$513.95</b>
550-341-10	0 (.4") - 12" / 0 (10) - 300mm	±.0015"	.0005" / 0.01mm	\$786.00	<b>\$746.70</b>
SPC cable with data switch - 1m: <b>05CZA624</b> 2m: <b>05CZA625</b>					
550-223-10**	0 (.5") - 18" / 0 (20) - 450mm	±.002"	.0005" / 0.01mm	\$985.00	<b>\$935.75</b>
550-225-10**	0 (.5") - 24" / 0 (20) - 600mm	±.002"	.0005" / 0.01mm	\$1,100.00	<b>\$1,045.00</b>
550-227-10**	0 (1") - 40" / 0 (20) - 1000mm	±.003"	.0005" / 0.01mm	\$1,970.00	<b>\$1,871.50</b>

\*( ) : Minimum dimension in ID measurement \*\*Models are not IP67 rated SPC cable w/ data switch - 1m: **959149** 2m: **959150**



### Neck Caliper

- > Point-jaw type can measure wall thickness inside bores and recesses.
- > Flat-jaw type can measure grooves and recesses.
- > With SPC data output.

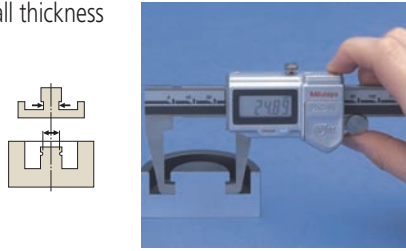
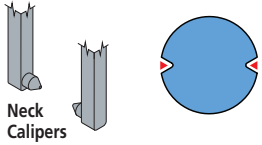

**MeasurLink** ENABLED  
Data Management Software by Mitutoyo

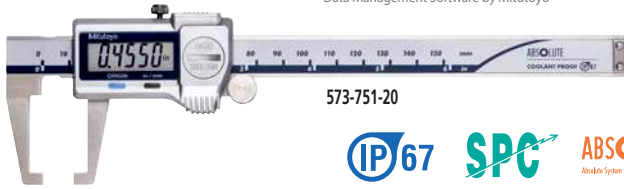

573-751-20

**IP67 SPC ABSOLUTE**  
Absolute System Powered by MITUTOYO

Order No.	Range	Accuracy	Resolution	List	Promo
573-751-20	0 - 6" / 0 - 150mm	±.0015"	.0005" / 0.01mm	\$687.00	<b>\$652.65</b>
573-752-20*	0 - 6" / 0 - 150mm	±.0015"	.0005" / 0.01mm	\$826.00	<b>\$784.70</b>

\*Point jaw

SPC cable with data switch – 1m: **05CZA624** 2m: **05CZA625**

### Digimatic Caliper with Nib and Standard Jaws

- > The rounded faces of the jaws are ideal for accurate ID (inside diameter) measurement.
- > With SPC output.

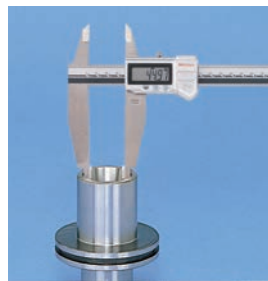

551-224-10

**MeasurLink** ENABLED  
Data Management Software by Mitutoyo

**IP67 SPC**

Order No.	Range*	Accuracy	Resolution	List	Promo
551-311-20	0 (.4") - 8" / 0 (10) - 200mm	±.0015"	.0005" / 0.01mm	\$596.00	<b>\$566.20</b>
SPC cable with data switch – 1m: <b>959149</b> 2m: <b>959150</b>					
551-224-10**	0 (.5") - 20" / 0 (20) - 500mm	±.0025"	.0005" / 0.01mm	\$1,260.00	<b>\$1,197.00</b>
551-226-10**	0 (.5") - 30" / 0 (20) - 750mm	±.0025"	.0005" / 0.01mm	\$2,040.00	<b>\$1,938.00</b>
551-227-10**	0 (1") - 40" / 0 (20) - 1000mm	±.003"	.0005" / 0.01mm	\$2,140.00	<b>\$2,033.00</b>

\*( ): Minimum dimension in ID measurement  
\*\* Models are not IP67 rated

SPC cable with data switch – 1m: **05CZA624** 2m: **05CZA625**

### Inside Caliper Knife-Edge/Inside Groove/Point Jaw

- > Special ID jaw calipers are designed for difficult-to-measure areas, such as ID grooves or recessed areas.
- > With SPC data output.



**IP67 SPC ABSOLUTE**  
Absolute System Powered by MITUTOYO

#### Knife edge



573-742-20

Measurable min. hole diameter:  $\phi$ .4"

**MeasurLink** ENABLED  
Data Management Software by Mitutoyo

#### Inside groove



573-745-20

Measurable min. hole diameter:  $\phi$ .4"

**MeasurLink** ENABLED  
Data Management Software by Mitutoyo

#### Point jaw



573-746-20

Measurable min. hole diameter:  $\phi$ .8"

**MeasurLink** ENABLED  
Data Management Software by Mitutoyo

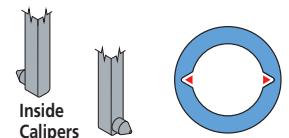

Inside Calipers

Order No.	Range	Accuracy	List	Promo
573-742-20	.4" - 8" / 10-200mm	±.002"	\$937.00	<b>\$890.15</b>
573-745-20	.4" - 6" / 10-150mm	±.002"	\$749.00	<b>\$711.55</b>
573-746-20	.8" - 6" / 20-150mm	±.002"	\$909.00	<b>\$863.55</b>

SPC cable with data switch – 1m: **05CZA624** 2m: **05CZA625**

**10% Off** - Plus Complimentary Accredited Calibration\* (A2LA 0750.01) and Shipping\*\*



5.7" color LCD

**MeasurLink** ENABLED  
Data Management Software by Mitutoyo

**Promo Price**  
**\$7,632**  
518-351A-21  
Order No.  
**PROMO027**

standard

**Promo Price**  
**\$8,091**  
518-352A-21  
Order No.  
**PROMO028**

with power grip

### Linear Height LH-600E

The Mitutoyo Linear Height LH-600E offers advanced performance for reliable and easy 2D measurement.

Measuring Range (stroke) 0-38" (24") / 0-972mm(600mm)

- > Excellent accuracy of  $(1.1+0.6L/600)\mu\text{m}$  with  $0.1\mu\text{m}/0.5\mu\text{m}$  resolution/repeatability.
- > Perpendicularity of  $5\mu\text{m}$  and straightness of  $4\mu\text{m}$  are guaranteed.
- > Pneumatic full/semi-floating system.
- > One-key operation for running a semi-automatic measurement.
- > Data entry from a Digimatic tool.

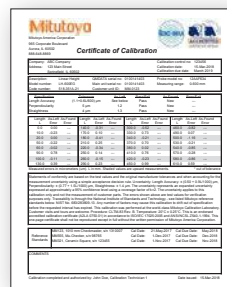

\*Complimentary accredited calibration applies to orders placed May 1 through July 31, 2019. Mitutoyo America Corporation reserves the right to change or discontinue this offer at any time. This offer is void wherever prohibited or restricted by law. No cash value. Complimentary accredited calibration will be conducted prior to unit shipping and cannot be applied toward previously placed orders. Refer to our terms and conditions for further details.

\*\*Complimentary ground shipping for the 48 contiguous United States. Offer applies to orders placed May 1 through July 31, 2019. Mitutoyo America Corporation reserves the right to change or discontinue this offer at any time. This offer is void wherever prohibited or restricted by law. No cash value. For Alaska and

Hawaii special rates apply. Contact us for details. Complimentary shipping cannot be applied toward previously placed orders. Orders may only be shipped to a single address. If customer returns product, they are responsible for the shipping cost. Refer to our terms and conditions for further details.

### Digimatic Height Gages (Multi-Function)

Now with two resolutions (.0002"/.0005"), two-value preset memory and increased character height for easier viewing.

- > Highly versatile, multi-function type.
- > Carbide-tipped long scriber is provided.
- > Rigid construction ensures repeatable measurement.
- > Switchable resolution.
- > Coarse/fine feed switching.
- > With SPC data output.
- > Two preset reference heights.
- > Inclined handle improves slider ergonomics.
- > Zero/ABS setting (ABS and INC modes)
- > Two-value preset memory
- > Data/hold
- >  $\pm$  Counting
- > Inch/mm conversion

**MeasurLink** ENABLED  
Data Management Software by Mitutoyo



Order No.	Range	Resolution	Accuracy	List	Promo
192-671-10	0-18"/0-450mm	.0005" (0.01mm)	$\pm 0015''$	\$2,350.00	<b>\$2,232.50</b>
192-672-10	0-24"/0-600mm	[.0002" (0.005mm) Switchable]	$\pm 0015''$	\$3,010.00	<b>\$2,859.50</b>

### Dial Height Gages

Double-column structure ensures high measuring accuracy. Coarse/fine feed switching. Carbide-tipped scriber.

- > Easy and error-free reading with both up and down digital counters as well as a dial.
- > Provided with a feed wheel for easy coarse feeding.
- > Carbide-tipped scriber is provided.
- > The counters and dial can be re-zeroed at any scriber position.
- > Fits comfortably in the hand and moves easily on the surface plate.



Easy and error-free reading



Order No.	Range	Graduation	List	Promo
192-150	0-12"	.001"	\$1,040.00	<b>\$988.00</b>
192-151	0-18"	.001"	\$1,440.00	<b>\$1,368.00</b>
192-152	0-24"	.001"	\$1,870.00	<b>\$1,776.50</b>



Dial Test Indicators

- > One piece movement for high-impact resistance and durability
- > Includes NIST-traceable Certificate of inspection - bidirectional



Part #	Range	Graduations	Set Type	Face Color	List	Promo	Remarks
<b>Standard</b>							
513-402-10E	.03"	.0005"	Basic	White	\$134.00	<b>\$120.60</b>	
513-402-10T	.03"	.0005"	Full	White	\$159.00	<b>\$143.10</b>	
513-403-10E	.008"	.0001"	Basic	White	\$174.00	<b>\$156.60</b>	
513-404-10E	0.8mm	0.01mm	Basic	Yellow	\$136.00	<b>\$122.40</b>	
513-404-10A	0.8mm	0.01mm	Plus	Yellow	\$149.00	<b>\$134.10</b>	
513-404-10T	0.8mm	0.01mm	Full	Yellow	\$160.00	<b>\$144.00</b>	
513-406-10T	.03"/0.7mm	.0005"/0.01mm	Full	White/Yellow	\$174.00	<b>\$156.60</b>	
513-409-10E	0.2mm/.0076"	0.002mm/.0001"	Basic	Yellow/White	\$202.00	<b>\$181.80</b>	
513-409-10T	0.2mm/.0076"	0.002mm/.0001"	Full	Yellow/White	\$205.00	<b>\$184.50</b>	
513-412-10E	.03"	.0005"	Basic	White	\$192.00	<b>\$172.80</b>	
513-415-10E	1.0mm	0.01mm	Basic	Yellow	\$144.00	<b>\$129.60</b>	Long stylus
513-415-10H	1.0mm	0.01mm	Basic	Yellow	\$158.00	<b>\$142.20</b>	Long stylus
<b>Ruby Tip</b>							
513-472-10E	.03"	.0005"	Basic	White	\$149.00	<b>\$134.10</b>	
513-479-10E	.03"	.0005"	Basic	White	\$158.00	<b>\$142.20</b>	Long stylus
<b>Standard (20° tilted face)</b>							
513-442-10T	.06"	.0005"	Full	White	\$205.00	<b>\$184.50</b>	
513-443-10A	.016"	.0001"	Basic	White	\$228.00	<b>\$205.20</b>	
513-446-16T	.06"	.0005"	Full	Black	\$273.00	<b>\$245.70</b>	
513-446-10A	.06"	.0005"	Basic	White	\$242.00	<b>\$217.80</b>	Long stylus
<b>Vertical: dial is on the top of the frame</b>							
513-452-10E	.03"	.0005"	Basic	White	\$174.00	<b>\$156.60</b>	
513-453-10E	.008"	.0001"	Basic	White	\$207.00	<b>\$186.30</b>	
<b>Parallel: dial is on the side of the frame</b>							
513-485-10E	0.2mm	0.002mm	Basic	Yellow	\$221.00	<b>\$198.90</b>	



Conventional

New

Scratch and smudge-resistant, anti-glare crystal for easy-to-read dial

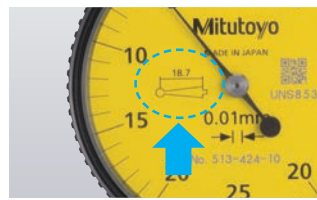

Contact point length is printed on dial face to avoid accuracy issues

Set Configuration

Inch

**Full set**

- Contact point, .039" DIA. carbide
- Contact point, .118" DIA. carbide
- Stem, .157" DIA. (21CAB106)
- Swivel clamp (900322, for .157" DIA., 3/8" DIA. dovetail)
- Inch holding bar (L: 4") (900306)

**Basic set**

- Contact point, .079" DIA. (Carbide)
- Indicator
- Knurled clamp ring
- Stem, .157" DIA. (21CAB106)
- Stem, 3/8" DIA.

**T set**

**E, A set**

Metric

**Full set**

- Swivel clamp (900321, for ø4mm, ø8mm, dovetail)
- Metric holding bar (L: 100mm) (900209)

**Plus set**

- Contact point, ø1mm carbide
- Contact point, ø3mm carbide
- Stem, ø4mm (21CAB106)

**Basic set**

- Contact point, ø2mm (Carbide)
- Indicator
- Knurled clamp ring
- Stem, ø8mm (Set No. 902804)

**T set**

**A set**

**C set (ø 6 Stem)**

**E set**

**H set (ø 6 Stem)**



VISIT US AT BOOTH 3111

May 14-16, 2019 | Eastern States Exposition  
West Springfield, MA

## Magnetic Stands

Mitutoyo Magnetic Stands accept all AGD-type dial indicators, test indicators and probes having .375", 6mm or 8mm diameter shanks and/or lug back with 1/4" diameter mounting hole. The On/Off switch offers instant mounting and dismounting without any adverse effect to the indicators or work surface.

Mitutoyo Magnetic Stands have 132 Lbf of magnetic force to help prevent damage to indicators and probes due to accidental base fall-over.

Order No	Description	Applicable holding stem dia.	List	Promo
7010S	Magnetic Stand w/6" Rod & Universal Clamp		\$135.00	\$121.50
7011BN	Magnetic Stand w/6" Adjustable Rod & Universal Clamp		\$153.00	\$137.70
7032B	Universal Magnetic Stand w/ mechanical locking system	ø6mm, ø8mm, ø9.53mm (3/8")	\$200.00	\$180.00
7033B	Universal Magnetic Stand w/mechanical locking system	ø6mm, ø8mm, ø9.53mm (3/8")	\$200.00	\$180.00

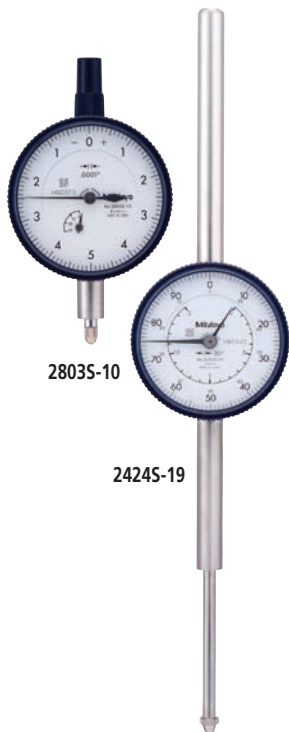
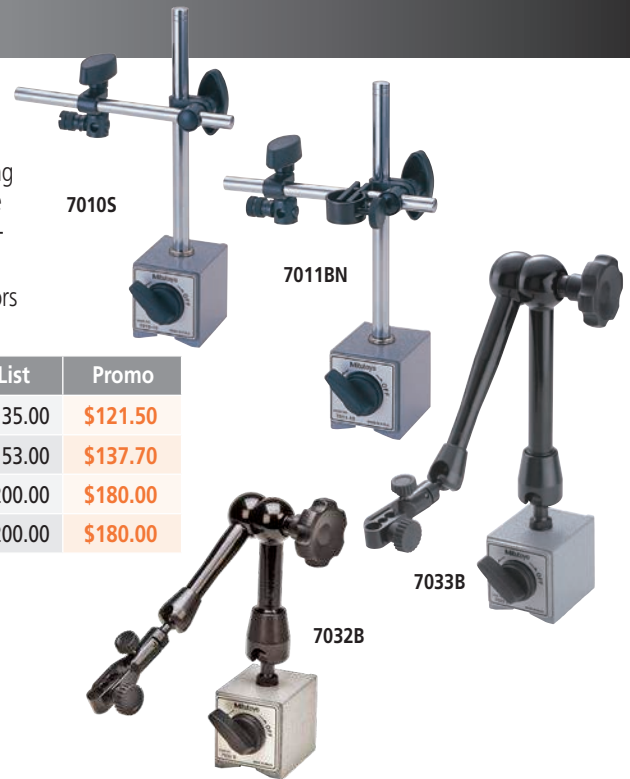

## Series Two Dial Indicators

- > High-strength, heat-treated stainless steel spindles for longevity
- > Scratch and chemical-resistant hard-coated crystals
- > Increased rigidity in the bearing plate for reducing the retracing error (20%) and 4-screw mounting for greater impact resistance
- > Inspection certificate included

Order No	Graduation	Range	Range/Rev	Type	Dial Reading	Accuracy First 2.5 Rev/Overall	Force	List	Promo
2358S-10	.0001"	.5"	.01"	w/lug	0-10	.0001 / .0008	2.0N or less	\$227.00	\$215.65
2803S-10	.0001"	.025"	.01"	w/lug	0-5-0	.0001 / .0001	2.5N or less	\$165.00	\$156.75
2416S-10	.001"	1"	.1"	w/lug	0-100	.001 / .002	1.8N or less	\$145.00	\$137.75
2424S-19	.001"	2"	1"	w/lug	0-100	.001 / .003	2.5N or less	\$227.00	\$215.65
2776S	.0005"	1"	.05"	w/lug	0-50	.0005 / .002	2.5N or less	\$146.00	\$138.70

## ABSOLUTE Digimatic Indicator ID-U

- > Slim, low cost, 1" range digital indicator
- > Large LCD and simple key operation.
- > After the initial origin setting, the ID-U no longer needs absolute positioning over the entire battery life; the origin is remembered even after power-off.
- > Ideal for installation into measuring devices because of compact design and long battery life.
- > Employing the ABSOLUTE linear encoder, the ID-U always displays the spindle Absolute Position from the origin at power-on. Also unlimited response speed eliminates overspeed errors.
- > Flat-back type, has no option for backs.

Order No.	Resolution	Range	Model	Accuracy	Measuring force	List	Promo
575-123	.0005"/0.01mm	1" / 25.4mm	ID-U1025E	.001"	1.8N or less	\$201.00	\$180.90



**ABSOLUTE**  
**SPC**

**MeasurLink** ENABLED  
Data Management Software by Mitutoyo

SPC cable - 1m: 905338 2m: 905409

www.mitutoyo.com

### ABSOLUTE Digimatic Indicator ID-S

- > Employing the ABSOLUTE linear encoder, the ID-S always displays the spindle Absolute Position from the origin at power-on. Also unlimited response speed eliminates overspeed errors.
- > Dust/Water protection level: IP42 (IP53: **543-795, 543-795B, and 543-796B**)
- > SPC data output.



**MeasurLink** ENABLED  
Data Management Software by Mitutoyo



Order No.	Resolution	Range	Accuracy	Measuring force	Remarks	List	Promo
<b>Stem dia. 3/8", #4-48 UNF Thread</b>							
543-783	.0005"/0.01mm	.5" / 12.7mm	±.0010"	1.5N or less	w/ lug back	\$182.00	<b>\$172.90</b>
543-783B	.0005"/0.01mm	.5" / 12.7mm	±.0010"	1.5N or less	w/ flat-back	\$182.00	<b>\$172.90</b>
543-792	.00005"/0.001mm	.5" / 12.7mm	±.0001"	1.5N or less	w/ lug back	\$281.00	<b>\$266.95</b>
543-792B	.00005"/0.001mm	.5" / 12.7mm	±.0001"	1.5N or less	w/ flat-back	\$281.00	<b>\$266.95</b>
543-796B	.00005"/0.001mm	.5" / 12.7mm	±.0001"	2.5N or less	w/ flat-back dustproof	\$310.00	<b>\$294.50</b>
543-793B	.0001"/0.001mm	.5" / 12.7mm	±.0001"	1.5N or less	w/ flat-back	\$281.00	<b>\$266.95</b>
<b>Stem ø 8mm, M2.5 x 0.45 Thread</b>							
543-782	.0005"/0.01mm	.5" / 12.7mm	±.001"	1.5N or less	w/ lug back	\$182.00	<b>\$172.90</b>
543-782B	.0005"/0.01mm	.5" / 12.7mm	±.001"	1.5N or less	w/ flat-back	\$182.00	<b>\$172.90</b>
543-795	.00005"/0.001mm	.5" / 12.7mm	±.0001"	2.5N or less	w/ lug back dustproof	\$319.00	<b>\$303.05</b>
543-795B	.00005"/0.001mm	.5" / 12.7mm	±.0001"	2.5N or less	w/ flat-back dustproof	\$319.00	<b>\$303.05</b>
543-791	.00005"/0.001mm	.5" / 12.7mm	±.0001"	1.5N or less	w/ lug back	\$290.00	<b>\$275.50</b>
543-791B	.00005"/0.001mm	.5" / 12.7mm	±.0001"	1.5N or less	w/ flat-back	\$290.00	<b>\$275.50</b>

SPC cable – 1m: 905338 2m: 905409

### IDC Digimatic Indicators

- > Absolute Encoder ensures all settings and readings maintained for the life of the battery (even when the power is turned off).
- > Preset, zero set, inch/mm, +/- direction and go/no-go functions.
- > Face rotates 330° for use at various angles.
- > Stem diameter: 3/8".
- > Immune to overspeed error.
- > SPC output provided.
- > Average battery life 7,000 hours using SR-44 battery (938882).

Order No.	Range	Remarks	List	Promo
<b>.0005"/0.01mm Resolution</b>				
543-402	.500"/12.7mm	Lug Back	\$319.00	<b>\$303.05</b>
543-402B	.500"/12.7mm	Flat Back	\$319.00	<b>\$303.05</b>
543-476B	1"/25mm	Flat Back	\$468.00	<b>\$444.60</b>
543-496B	2"/50mm	Flat Back	\$615.00	<b>\$584.25</b>
<b>.00005"/.0001"/.0005"/0.001mm/0.01mm selectable resolutions</b>				
543-392	.500"/12.7mm	Lug Back	\$437.00	<b>\$415.15</b>
543-392B	.500"/12.7mm	Flat Back	\$437.00	<b>\$415.15</b>
543-472B	1"/25mm	Flat Back	\$585.00	<b>\$555.75</b>
543-492B	2"/50mm	Flat Back	\$734.00	<b>\$697.30</b>

SPC cable – 1m: 905338 2m: 905409



Now with multiplier function  $f(x)=Ax$   
(other models available with  $Ax+B+Cx-1$  function; see page 15)

**MeasurLink** ENABLED  
Data Management Software by Mitutoyo



## Calculation-Type Digimatic Indicator ID-C

- > The Absolute Digimatic indicator performs internal calculations using the formula  $Ax+B+Cx-1$  (assuming spindle displacement as  $x$ ), while the specified coefficients A, B and C can be set with respect to the purpose of measurement or dimensions of the fixtures. This unique feature allows for reading measurements directly, without fumbling for conversions.
- > Calculation-Type Digimatic Indicator features both a key lock and parameter lock.
- > Fast measurement frequency up to 50 per second.
- > An analog bar provides easy-to-read values when scanning for Max, Min and TIR Values.

- > Improved parameter setting software makes it even easier to set all of the available parameters and determine and upload the proper coefficients for calculation. (optional) **21EZA313**



**MeasurLink** ENABLED  
Data Management Software by Mitutoyo



www.mitutoyo.com/idccal  
VIDEO DEMO



Stem dia. 3/8" #4-48 UNF Thread

Order No.	Resolution	Range	Accuracy	Measuring Force	List	Promo
<b>543-342B</b>	.00005"/.0001"/.0005" (0.001/0.01mm)	.5"/12.7mm	±.00010"/0.003mm	1.5N or less	\$458.00	<b>\$412.20</b>
<b>543-592B</b>	Selectable	1"/25.4mm	±.00010"/0.003mm	1.8N or less	\$614.00	<b>\$552.60</b>
<b>543-597B</b>		2"/50.8mm	±.00025"/0.006mm	2.3N or less	\$770.00	<b>\$693.00</b>

SPC cable – 1m: **905338** 2m: **905409**



## Digimatic Indicator ID-H

Remote Programming Capable

- > This digital indicator offers the functionality and accuracy expected from this class of indicator. Take advantage of its high accuracy backed by  $0.5\mu\text{m} / .00002"$  resolution, remote control functionality via a handheld controller (or an RS-232C interface) and easy runout measurements with the well-established analog bar display.

- > The maximum, minimum or runout value can be displayed during measurement.
- > Go/no-go judgment is performed by setting the upper and lower tolerances. If a judgment result is out of tolerance, the display backlighting changes from green to red, so tolerance judgment can be made at a glance.
- > With SPC output and RS-232C input/output

Stem dia. 3/8" #4-48 UNF Thread

Order No.	Resolution	Range	Model	Accuracy	List	Promo
<b>543-562A</b>	.00002", .00005", .0001", 0.0005mm,	1.2" / 30.4mm	ID-H530E	.00006" / 0.0015mm	\$909.00	<b>\$818.10</b>
<b>543-564A</b>	0.001mm	2.4" / 60.9mm	ID-H560E	.0001" / 0.0025mm	\$1,080.00	<b>\$972.00</b>

SPC cable – 1m: **936937** 2m: **965014**

**21EZA099**  
Remote controller  
(optional)



**543-564A**



**MeasurLink** ENABLED  
Data Management Software by Mitutoyo

## ABSOLUTE Digimatic Indicator ID-F

- > With the ABSOLUTE linear encoder technology, once the measurement reference point has been preset, it will not be lost when the power is turned on.
- > Go/no-go judgment is performed by setting the upper and lower tolerances. If a judgment result is out of tolerance, the display backlighting changes from green to red, so tolerance judgment can be made at a glance.
- > The maximum, minimum or runout value can be displayed during measurement.

- > An analog bar indicator has been integrated to handle upper/lower limit approaching and zero approaching. It enhances the ease of operation in the same manner as a dial indicator. The display range of the analog bar can be changed.



**543-552A**



**MeasurLink** ENABLED  
Data Management Software by Mitutoyo

Stem dia. 3/8" #4-48 UNF Thread

Order No.	Resolution	Range	Model	Accuracy	List	Promo
<b>543-552A</b>	.00005", .0001", .0005", .001", 0.001mm, 0.01mm	1" / 25.4mm	ID-F125E	.00012"	\$687.00	<b>\$618.30</b>

SPC cable – 1m: **936937** 2m: **965014**

**Rockwell and Rockwell Superficial Hardness Tester**

With Real-Time Electronic Test Force Control



- > Closed-loop control of testing forces
- > Primary and final forces (loads) are applied with unparalleled accuracy and repeatability
- > Extended indenter arm reaches inside diameters and hard-to-reach surfaces at eye level, allowing the operator to easily see where the indenter accesses small or hard-to-reach parts
- > Automatic setting of preliminary test force and application of total test force
- > Indenter escape function allows automatic removal of preliminary test force at end of test cycle
- > Touch-screen operation with color LCD
- > Hardness scale is set automatically via the touch screen
- > Cylindrical and spherical surface compensation
- > Auto conversion to all hardness scales or tensile strength



**HR-530**  
(810-237)

Order No.	810-237	
Model	HR-530	
Hardness testing methods	Rockwell/Rockwell Superficial/Brinell/Plastics hardness	
Initial test force (N)	29.42N (3kgf), 98.07N (10kgf)	
Test force (N)	Rockwell Superficial	147.1N (15kgf), 294.2N (30kgf), 441.3N (45kgf)
	Rockwell	588.4N (60kgf), 980.7N (100kgf), 1471N (150kgf)
	Light Force Brinell	61.29 (6.25kgf), 98.07 (10kgf), 153.2 (15.625kgf), 245.2 (25kgf), 294.2 (30kgf), 306.5 (31.25kgf), 612.9 (62.5kgf), 980.7 (100kgf), 1226 (125kgf), 1839 (187.5kgf)
Test force control	Automatic (load/hold/unload)	
Table up/down mechanism	Manual (automatic braking and load sequencing)	
Test force switching	Operated with the display unit	
Test force hold time	1 to 120s (Selectable in units of 1s)	
Maximum specimen size	Height: 9.8" (250 mm)	
	Depth: 5.9" (150 mm)	
Permissible inside diameter of a tube specimen	Minimum hole diameter: 1.38" (35 mm) (when using the special indenter: .87" (22 mm))	
Display	Hardness value, test condition, go/no-go judgment result, statistical calculation result, X-R control chart, hardness conversion value	
	Conversion function [HV, HK, HR (Rockwell hardness A, B, C, D, F, G / Rockwell Superficial 15T, 30T, 45T, 15N, 30N, 45N), HS, HB, tensile strength]	
	Go/no-go judgment function	
	Continuous test function (for specimens with the same thickness)	
	Cylindrical correction, spherical correction, offset correction, multi-point correction functions	
External data output	Statistical calculation function (maximum value, minimum value, mean value, standard deviation, upper limit value, lower limit value, go count, range, no-go count)	
	Graph generation function (X-R control chart)	
External data output	RS-232C, digimatic, USB2.0	
External dimensions	Main unit	9.84" x 26.38" x 23.82" (250(W)x667(D)x621(H) mm)
	Touch-panel display	11.8" x 26.2" x 30.1" (300(W)x667(D)x766(H) mm)
Mass	Approx. 60 kg	
List	\$13,500.00	
Promo	\$12,825.00	

**Function: Touch-screen type**

- Touch-screen operation with a back-lit LCD graphic display.
- Remote selection of the test force linked to the hardness scale selection.
- Choice of language: English, German, French, Spanish, Italian and Japanese.
- Cylindrical and spherical surface compensation.
- Data offset.
- Conversion to other hardness scales.
- Powerful statistical processing with flexible data point editing and 1024 data memory.
- Measured data editing
- Go/no-go tolerance judgment.
- Statistical processing, histogram and X-R chart

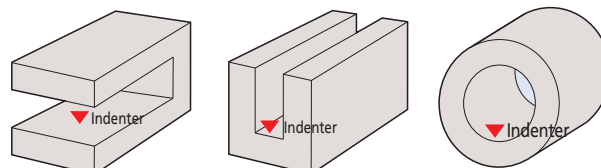

**Various shapes of specimen can be measured.** (Nose-type indenter axis mechanism has been adopted.) The nose-type indenter mechanism allows measurement of pipe samples as well as the top surface of a flat sample.

Prices effective May 1 through July 31, 2019

## Durometers (Digital and Analog) For Rubber and Plastics Hardness Testing

> Durometers are suitable for testing natural rubber, neoprene, polyesters, PVC, leather, Thiokol, nitril, wax, vinyl, cellulose acetates, glass, polystyrol and other materials.



Compact Dial  
811-336-10



Compact Digital  
811-336-10

**MeasurLink** ENABLED  
Data Management Software by Mitutoyo

Order No	Model	Scale	Display	Graduation	Range	Indenter	List	Promo
811-335-10	HH-335	Shore A	Analog	1.0	10~90	Blunt Taper	\$599.00	\$569.05
811-336-10	HH-336	Shore A	Digital	0.5	10~90	Blunt Taper	\$1,280.00	\$1,216.00
811-337-10	HH-337	Shore D	Analog	1.0	20~90	Sharp Point	\$599.00	\$569.05
811-338-10	HH-338	Shore D	Digital	0.5	20~90	Sharp Point	\$1,280.00	\$1,216.00
64AAA964	Test Block Set (Shore A Scale)						\$188.00	\$178.60
64AAA590	Test Block Set (Shore D Scale)						\$188.00	\$178.60
64AAA962	A Scale Durometer Stand						\$959.00	\$911.05
64AAA796	D Scale Durometer Stand						\$2,500.00	\$2,375.00



## HH-411 Hardmatic

Rebound portable hardness tester featuring reproducibility and ease of operation on large parts. It is lightweight and can be carried into the shop or out in the field.

**MeasurLink** ENABLED  
Data Management Software by Mitutoyo



Order No.	Type	List	Promo
810-298-10	HH-411 Hardmatic	\$3,990.00	\$3,790.50

Model	HH-411		
Order No.	810-298-10		
Hardness Range	L-Value (ASTM A956)		
Detector	Input device D (carbide ball)		
Display	<b>Hardness</b>	<b>Range</b>	<b>Resolution</b>
	HL	1-999 HL	1 HL
	HV	43-950 HV	1 HV
	HB	20-894 HB	1 HB
	HRC	19.3-68.2 HRC	0.1 HRC
	HRB	13.5 - 101.7 HRB	0.1 HRB
	HS	13.2 - 99.3 HS	0.1 HS
	HTN	499 - 1996 Mpa	1 Mpa
Functions	Conversions: HL, HV, HB, HRC, HRB, HS, HTN Judgment: OK/NG Offsetting Memory: 1,800 data		
Output	RS-232C, SPC		
Power supply	Alkaline AA Battery 2pcs.		
Dimensions	Detector: (Dia. X H) 1.10" x 6.89" (28 x 175mm) Display: (W x D x H) 2.76" x 4.33" x 1.38" (70 x 110 x 35mm)		
Mass	Detector: .26lbs (120g) Display: .44lbs (200g)		

**eastec**<sup>®</sup>  
VISIT US AT BOOTH 3111  
May 14-16, 2019 | Eastern States Exposition  
West Springfield, MA



**Ultra-High Accuracy**

**Laser Scan Micrometer LSM-6902H**

**MeasurLink** ENABLED  
Data Management Software by Mitutoyo

- Improved narrow range Repeatability of 0.03µm / 1.2µin
- The best repeatability available in the 25mm/1" class.
- The ultra-precise scanning motor enables the highest measurement accuracy.
- Thanks to excellent linearity, an accuracy of ±0.5µm over the entire measuring range and a higher accuracy of ±(0.3+0.1ΔD)µm over a narrow range are guaranteed.
- An excellent option for measuring pin gages or plug gages.



544-499A

Order Number	Range	Resolution	List	Promo
544-499A	.004" - 1.0"/0.1mm - 25mm	.000001" - .0005"/0.00001 - 0.01mm	\$12,200.00	<b>\$10,980.00</b>
544-116-1A	.020" - 2.36"/0.5mm - 60mm	.000002" - .005"/0.00005 - 0.1mm	\$8,940.00	<b>\$8,046.00</b>

**QUICKTOOL\*** is free downloadable software that makes programming the LSM-6200 quick and easy.  
\*For use with customer-supplied PC and optional RS-232C cable.

**Bench Top**

**Laser Scan Micrometer LSM-9506**

- Integrated display and measuring unit in one unit.
- Statistical calculation mode.
- RS-232C output, I/O interface, and SPC output interface are standard.



544-116-1A



www.mitutoyo.com/LSM  
VIDEO DEMO

**High-Accuracy Non-Contact Measuring Systems**

- Excellent linearity: down to +/- 0.3 micron.
- High-speed scanning capable: 3,200 scans per second.
- Various ranges available for selecting the best laser for your application.
- Statistical calculation mode.
- Memory function has been increased to allow storage of up to 100 programs.

**QUICKTOOL\*** is free downloadable software that makes programming the LSM-6200 quick and easy.  
\*For use with customer-supplied PC and optional RS-232C cable.



**MeasurLink** ENABLED  
Data Management Software by Mitutoyo

**LSM-6200 Display Unit Included**

Order No	Model	Range Inch	Range mm	Repeatability	Linearity	Scanning Rate	List	Promo
64PKA117	LSM-500S	.0002" - .08"	0.005~2mm	±0.03µm	±0.3µm	3,200 scans/sec	\$10,370.00	<b>\$7,090.00</b>
64PKA118	LSM-501S	.002" - .4"	0.05~10mm	±0.04µm	±0.5µm <sup>†</sup>	3,200 scans/sec	\$9,330.00	<b>\$6,050.00</b>
64PKA119	LSM-503S	.012" - 1.18"	0.3~30mm	±0.11µm	±1.0µm <sup>†</sup>	3,200 scans/sec	\$10,110.00	<b>\$6,830.00</b>
64PKA120	LSM-506S	.04" - 2.36"	1~60mm	±0.36µm	±3µm <sup>†</sup>	3,200 scans/sec	\$11,480.00	<b>\$8,200.00</b>
64PKA121	LSM-512S	.04" - 4.72"	1~120mm	±0.85µm	±6µm <sup>†</sup>	3,200 scans/sec	\$17,680.00	<b>\$14,400.00</b>
64PKA122	LSM-516S	.04" - 6.30"	1~160mm	±1.4µm	±7µm <sup>†</sup>	3,200 scans/sec	\$28,480.00	<b>\$25,200.00</b>

<sup>†</sup> Linearity over entire range. Higher accuracies are possible over smaller ranges.

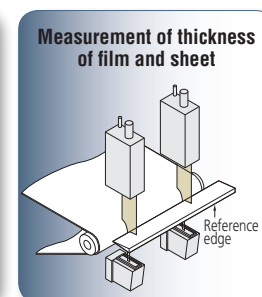
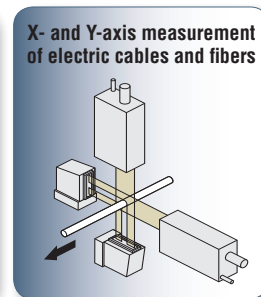
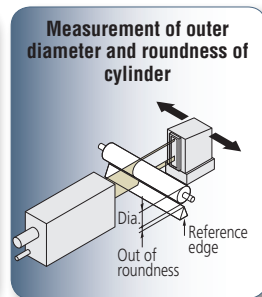
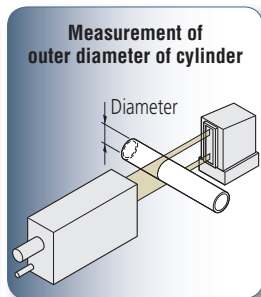
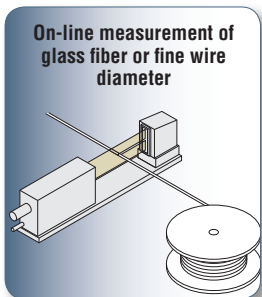

## ABSOLUTE Digimatic Scale Units

- > The Origin key allows setting of an absolute zero point to be used as reference in subsequent measurements. Once set, the ABS Digimatic Scale Unit is ready to show its true position whenever turned on, rather than 0.00" as with standard models.
- > The Zero/ABS key allows the display to be zero-set at any slider position along the beam for incremental comparison measurements. This key will also allow return to the absolute coordinate with a display of the true position from the origin point.
- > No rack, no pinion, no glass scale. Digimatic scale unit is safely embedded in the hardened stainless steel blade.
- > Horizontal or vertical face according to the scale mounting direction.
- > Multi-function types with diameter displaying function are also available for lathes. (Contact Mitutoyo.)
- > All units come with two mounting brackets, each located at either end of the scale.
- > Auto power on and off shut off after 20 minute of idle time.
- > With SPC data output.

**ABSOLUTE™**



572-313-10

**SPC**



572-210-30

**MeasurLink™ ENABLED**  
Data Management Software by Mitutoyo

Order No	Model	Range	Accuracy	Resolution	Type	List	Promo
572-210-30	SD-4"DX	0-4" / 0-100mm	.001" / 0.03mm	.0005" / 0.01mm	Horizontal single-function	\$235.00	<b>\$223.25</b>
572-211-30	SD-6"DX	0-6" / 0-150mm	.001" / 0.03mm	.0005" / 0.01mm	Horizontal single-function	\$249.00	<b>\$236.55</b>
572-212-30	SD-8"DX	0-8" / 0-200mm	.001" / 0.03mm	.0005" / 0.01mm	Horizontal single-function	\$290.00	<b>\$275.50</b>
572-310-10	SDV-4"D	0-4" / 0-100mm	.001" / 0.03mm	.0005" / 0.01mm	Vertical single function	\$260.00	<b>\$247.00</b>
572-311-10	SDV-6"D	0-6" / 0-150mm	.001" / 0.03mm	.0005" / 0.01mm	Vertical single-function	\$276.00	<b>\$262.20</b>
572-313-10	SDV-12"D	0-12" / 0-300mm	.002" / 0.04mm	.0005" / 0.01mm	Vertical single function	\$616.00	<b>\$585.20</b>

## Applications

Machine table position

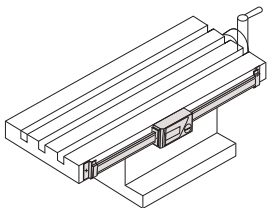

Drilling machine stroke position

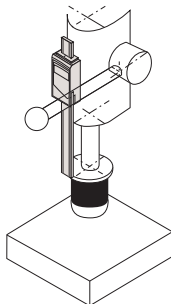

Focus setting on optical instruments

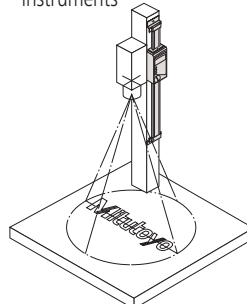

## Special Applications

As a measurement jig for outdoor use (SD-G)

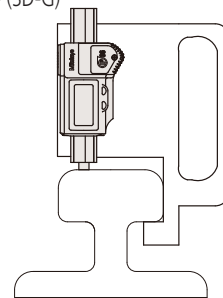

Detector head mechanism

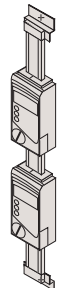

Mitutoyo's Digital Readout Packages

Mounting Hardware Included on all machine retrofit packages

All DRO Packages Include:

- > KA-200 Counter
- > KA-200 Counter tray/arm kit
- > Linear Scales
- > Bracket Kit(s)



SAVE  
**\$200**  
PER PACKAGE

MeasurLink<sup>®</sup> ENABLED  
Data Management Software by Mitutoyo

Package Part No.	Description	X Travel	Y Travel	Z Travel	X Axis Type	Y Axis Type	Z Axis Type	List	Promo
64PKA058A	12" X 30" DRO Mill Package	30"	12"		AT715	AT715		\$1,490.00	\$1,290.00
64PKA059A	12" X 36" DRO Mill Package	36"	12"		AT715	AT715		\$1,490.00	\$1,290.00
64PKA060A	14" X 30" DRO Mill Package	30"	14"		AT715	AT715		\$1,490.00	\$1,290.00
64PKA062A	16" X 36" DRO Mill Package	36"	16"		AT715	AT715		\$1,490.00	\$1,290.00
64PKA063A	16" X 40" DRO Mill Package	40"	16"		AT715	AT715		\$1,490.00	\$1,290.00
64PKA035A	6" X 28" Lathe Package	6"		28"	AT116		AT715	\$1,450.00	\$1,250.00
64PKA039A	8" X 40" Lathe Package	8"		40"	AT116		AT715	\$1,450.00	\$1,250.00
64PKA042A	10" X 40" Lathe Package	10"		40"	AT116		AT715	\$1,450.00	\$1,250.00
64PKA046A	12" X 40" Lathe Package	12"		40"	AT116		AT715	\$1,450.00	\$1,250.00
64PKA050A	12" X 60" Lathe Package	12"		60"	AT116		AT715	\$1,650.00	\$1,450.00
64PKA052A	14" X 40" Lathe Package	14"		40"	AT116		AT715	\$1,450.00	\$1,250.00
64PKA057A	16" X 60" Lathe Package	16"		60"	AT116		AT715	\$1,650.00	\$1,450.00
64PKA026A	6" X 12" Grinder Package	6"		12"	AT116		AT116	\$1,620.00	\$1,420.00
64PKA028A	8" X 12" Grinder Package	8"		12"	AT116		AT116	\$1,620.00	\$1,420.00
64PKA029A	8" X 14" Grinder Package	8"		14"	AT116		AT116	\$1,620.00	\$1,420.00

Trinocular Stereo Microscope MSM-414TL

- > Continuous 1X - 4X magnification
- > Image always in focus throughout zoom range
- > Crisp, erect images with high resolution and excellent stereoscopic effect
- > Stereo-tube can be rotated a full 360° for viewing at any angle
- > Bilateral zoom control knob adds convenience and increases operator efficiency
- > Diopter adjustment for both eyepieces

Model	MSM-414TL
Order No.	377-974A
Optical tube	Trinocular
Total magnification	10X - 40X
Eyepiece	10X (377-016)
Objective	1X - 4X
Working distance	80mm
Field of view	20mm - 5mm
Dimensions	H=13.2" x W=6.7" x D=9.3"
Mass	13.2 lbs (6kg)



Order No.	Description	List	Promo
377-974A	MSM-414TL Stereo Microscope	\$1,380.00	\$1,311.00
377-481	C-mount Video Adapter for MSM-414TL	\$53.85	\$51.16
64AAB526	Moticam 1080, 2.0 Mega Pixels, HDMI/USB	\$1,250.00	\$1,187.50



Camera with software for digital viewing

Prices effective May 1 through July 31, 2019



## MF Measuring Microscopes

- › Observation with a crisp and high-resolution erect image and a wide field of view.
- › Measuring accuracy that is highest in its class (and conforms to JIS B 7153).
- › Included 3x objective and binocular eyetube.
- › Illumination unit (reflected/transmitted) selectable from a high-intensity LED.
- › Quick-release mechanism useful for moving the stage quickly when measuring workpieces that are large in size or quantity.
- › Dedicated camera port allows for simultaneous eyepiece and digital observation.



176-861-10

Model No. (XY stage size)	1010D
Order No.	176-861-10
XY stage travel range	4 x 4" / 100 x 100mm
Z-axis travel range	6" / 150mm
Focusing method	Manual focusing (Coarse focusing: 30mm/rev., Fine focusing: 0.2mm/rev.)
Measurement method	Linear encoder (2-axis model: X / Y-axis, 3-axis model: X / Y / Z-axis)
Resolution (switchable)	.0001" / .00005" / .00001" (0.001mm / 0.0005mm / 0.0001mm)
Measuring accuracy (at 20°C)	XY-axis: (2.2+0.02L) $\mu$ m, L = Measuring length (mm) when not loaded, JIS B 7153
Indication accuracy (at 20°C)	Z-axis: (5+0.04L) $\mu$ m, L = Measuring length (mm), (MF-B type)
Floating function	X and Y axes with Quick-release mechanism
XY stage top size	11 x 11" / 280 x 280mm
Effective glass size	7 x 7" / 180 x 180mm
Max. stage loading	22lbs / 10kg
Max. workpiece height	6" / 150mm

Order No	Description	List	Promo
<b>64PKA092A</b>	<b>MF-A1010D Package</b>		
176-861-10	MF-A1010D	\$18,960.00	<b>\$17,064.00</b>
176-445A	LED Illumination unit (MF)		
176-393	Binocular Tube		

## TM Toolmakers' Microscopes

- › Angle measurement is performed easily by turning the angle scale disc to align the cross-hair reticle with the workpiece image.
- › Illumination intensity can be adjusted.
- › Included standard accessories create an overall magnification of 30X. Magnifications can be changed from 20 - 200X by using optional objectives and/or eyepieces.



Conventional illumination



Newly designed LED illumination



TM-A505B  
176-820A

Model No.	TM-505B	TM-A505B	TM-1005B	TM-A1005B	
Order No.	176-818A	176-820A	176-819A	176-821A	
Eyepiece	Standard accessory: 15X (field number: 13), Options: 10X, 20X				
Objective lens	Standard accessory: 2X, Options: 5X, 10X				
Microscope head	Maximum height of workpiece	4.53" / 115mm	4.21" / 107mm		
Illumination unit	Transmitted illumination	Stepless brightness adjustment, White LED light source, With green filter			
	Surface illumination	Oblique single-source type, Stepless brightness adjustment, White LED light source			
Cross-travel stage	Measuring range	2" x 2" / 50x50mm	4" x 2" / 100x50mm (An optional 2" / 50mm gauge block is required to cover full range. A CERA block is recommended.)		
	Usable area of the stage glass	3.8" x 3.8" / 96x96mm	6" x 3.8" / 154x96mm		
	Maximum stage glass loading	11 lbs. / 5kg			
Linear measurement method	Micrometer heads optional	Micrometer heads included	Micrometer heads optional	Micrometer heads included	
	<b>List</b>	\$3,790.00	\$5,590.00	\$5,490.00	\$7,290.00
	<b>Promo</b>	<b>\$3,411.00</b>	<b>\$5,031.00</b>	<b>\$4,941.00</b>	<b>\$6,561.00</b>

# Complimentary Shipping on ALL Profile Projectors\*

DOMESTIC U.S. ORDERS ONLY



\*Complimentary ground shipping for the 48 contiguous United States. Offer applies to orders placed May 1 through July 31, 2019. Mitutoyo America Corporation reserves the right to change or discontinue this offer at any time. This offer is void wherever prohibited or restricted by law. No cash value. For Alaska and Hawaii special rates apply. Contact us for details.

Complimentary shipping cannot be applied toward previously placed orders. Orders may only be shipped to a single address. If customer returns product, they are responsible for the shipping cost. Refer to our terms and conditions for further details.

## PJ-A3000 Vertical Profile Projector

- > A series of midsize profile projectors featuring bright, 12.40" (315mm) diameter screens and easy-to-operate XY measurement tables.
- > A floating table makes measuring quick and easy.
- > Built-in, easy-to-read digital counters are located near the projection screen, thereby minimizing strain associated with excessive movement.
- > For edge-sensing capabilities, order the Optoeye-200, part number 332-151.



PJ-A3010F-200

## PV-5110 Profile Projector

- > Large 500mm screen
- > Floor model uses a downward illumination system.
- > Digital readout protractor screen (including zero-setting, ABS/INC coordinate switching functions) for easy and error-free angle measurement.
- > Angled screen allows projected images to be easily traced or compared with a template.
- > The oblique surface illumination system provides clear and bright images, allowing easy inspection of non-reflective workpieces such as plastic parts or printed materials.



PV-5110

### Standard Accessories

- > 200 x 100mm (8 x 4") XY travel
- > 10x projection lens set
- > Surface illumination unit
- > Counter stand for KA counter
- > Power cord, halogen bulb, fuse, grounding wire, allen wrench, vinyl cover

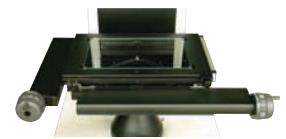

MeasurLink ENABLED  
Data Management Software by Mitutoyo

Order No.	Description	List
304-919A	Profile Projector PV-5110	\$19,500.00
264-156A	QM-Data200 (Arm-Mount Model)	\$2,720.00
332-151	Optoeye-200	\$1,650.00
12AAE672	Attachment (B) for Optoeye-200	\$58.65
174-183A	KA 200 Counter	\$587.00

MeasurLink ENABLED  
Data Management Software by Mitutoyo

Order No.	Description	XY Travel	List
302-701A	PJ-A3010F-200	8" x 4"	\$13,600.00
302-702A	PJ-A3005F-150	6" x 2"	\$12,000.00
302-703A	PJ-A3010F-100	4" x 4"	\$10,800.00
302-704A	PJ-A3005D-50	2" x 2"	\$8,890.00
64PMI167	OPTIONAL STAND FOR PJ-A3000, 24.4"x20"x32" (CHARCOAL GRAY, RAL7016 RTM)		\$688.00

Prices effective May 1 through July 31, 2019

## PH-A14 Profile Projector and 2D Processor Packages

Horizontal projector equipped with highly accurate linear glass scales and touch screen M2 geometric measurement display

### Features:

- ø14" Screen, Horizontal Projector
- 8" x 4" Travel T Slot table for accessories
- Linear Glass Scales for accurate movement
- Profile and Fiber Optic Surface Illumination
- Easy to use all-in-one PC Touch Screen Display
- M2 Geometric 2D Measurement Software
- Optional Edge Detection (64PKA155) for fast and repeatable measurements



QM Data  
2-D Data  
Processing Unit

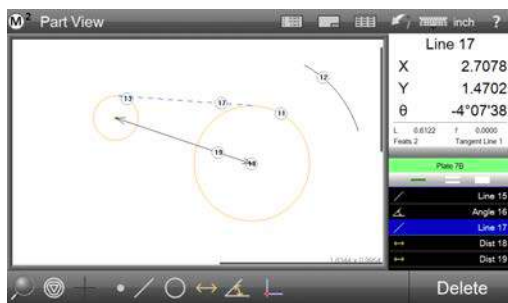

### Graphics-based "Part View" constructions

Generate popular construction types, like Distances and Tangent Lines, from within the graphical part view.

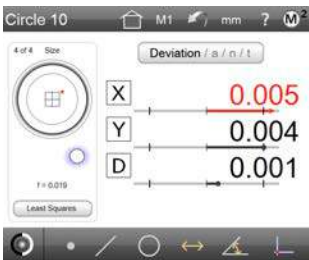

### Geometric tolerancing

Measure features, set nominals, apply tolerances and view deviation results with only a few quick clicks.



**Reports** Flexibility for report contents and formatting allows for full customization of the data format, header information, and header and footer graphics.



Optoeye-200  
Edge detection system



KA 200 Counter

### PH-A14 Specifications

Model No.	PH-A14	
<b>Base Unit</b>	<b>172-810-10A*</b>	
Projected Image	Inverted image	
Protractor screen	Effective diameter	14" / 356mm
	Screen material	Fine ground glass
	Reference line	Cross hair line
	Screen rotation	±360°, fine feed and clamp
	Angle display	Vernier reading, Resolution: 2'
Projection lens	Standard accessory: 10x(172-011), Optional accessories: 20X, 50X, 100X	
Magnification accuracy	Contour illumination	±0.1% or less
	Surface illumination	±0.15% or less
Contour illumination	light source	Halogen bulb(24V 150W)
	Optical system	Telecentric system
	Functions	Heat-absorbing filter, Cooling fan
Surface illumination	light source	Halogen bulb(24V 150W)
	Optical system	Twin fiber optic illumination
XY Stage	Table travel (X-axis)	8" / 203.2mm
	Table size(X, Z)	16 x 6" / 407 x 153mm
	Vertical travel (Y-axis)	4" / 101.6mm
	Resolution	.00005" / 0.001mm*
	Measuring Unit	Built in Linear scale
	Max. workpiece width	See (L) on page I-12
	Max. workpiece load	100lbs / 45kg
Power supply	120V AC, 50/60Hz	
Mass	308lbs / 140kg	
Standard accessories	10x projection lens set, work stage, power cord, halogen bulb, fuse, grounding wire, allen wrench	

\*Counter not included

Order No.	Description	List
<b>64PKA154A</b>	PH-A14 PROFILE PROJECTOR - WITH TOUCH SCREEN M2 GEOMETRIC DISPLAY	\$10,490.00
<b>64PKA155A</b>	PH-A14 PROFILE PROJECTOR - WITH OPTICAL EDGE DETECTION AND TOUCH SCREEN M2 GEOMETRIC DISPLAY	\$11,900.00

(Includes installation and A2LA accredited calibration)

### Other packages available

Order No.	Description	List
<b>64PKA086A</b>	PH-A14 w/KA-200 Counter & Tray	\$7,490.00
<b>64PKA087</b>	PH-A14 w/QM Data (Arm Mount)	\$9,490.00



## SPRING PROMO 2019

### PRECISION TOOLS & INSTRUMENTS

Mitutoyo products are sold only through authorized distributors. To find an authorized Mitutoyo distributor near you, visit: [www.mitutoyo.com/distributor-locator/](http://www.mitutoyo.com/distributor-locator/)

#### 2019 Remaining Tradeshow Schedule:

- OTC - May 6, 2019 - Houston, TX - Booth #8553
- EASTEC - May 14, 2019 - West Springfield, MA - Booth #3111
- NCSLI International - Aug 26, 2019 - Cleveland, OH - Booth #409
- WESTEC - Sep 24, 2019 - Long Beach, CA - Booth #1209
- Neuroscience Show - Oct 19, 2019 - Chicago, IL - Booth #531
- The Quality Show - Oct 22, 2019 - Rosemont, IL - Booth #1308



**Note:** All information regarding our products, and in particular the illustrations, drawings, dimensional and performance data contained in this printed matter as well as other technical data are to be regarded as approximate average values. We therefore reserve the right to make changes to the corresponding designs. The stated standards, similar technical regulations, descriptions and illustrations of the products were valid at the time of printing. In addition, the latest applicable version of our General Trading Conditions will apply. Only quotations submitted by ourselves may be regarded as definitive. Specifications are subject to change without notice.

Mitutoyo products are subject to US Export Administration Regulations (EAR). Re-export or relocation of our products may require prior approval by an appropriate governing authority.

#### Trademarks and Registrations

Designations used by companies to distinguish their products are often claimed as trademarks. In all instances where Mitutoyo America Corporation is aware of a claim, the product names appear in initial capital or all capital letters. The appropriate companies should be contacted for more complete trademark and registration information.

We reserve the right to change specifications and prices without notice. Not valid with any other offer or promotion, previous purchases. Please refer to terms and conditions for additional information. Domestic U.S. orders only.

© 2019 Mitutoyo America Corporation

40M 0419-01 • Printed in USA • April 2019

# SPRING PROMO 2019

## PRECISION TOOLS & INSTRUMENTS

Effective May 1 through July 31, 2019

SPRING PROMO 2019

**MeasurLink** ENABLED

Data Management Software by Mitutoyo

