

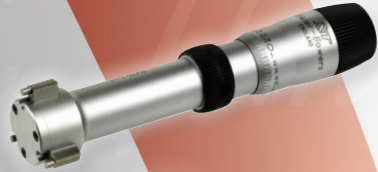

HIGH PRECISION

TOOL-A-THON[®]

Vol. 19.3



over
30 NEW
items!



Preferred Fowler Distributor:
sales@willrich.com / Ph 866-945-5742

Valid 9/1 - 12/31

American Made Tools!

Find us on social media!

YouTube
LinkedIn
Twitter
Facebook

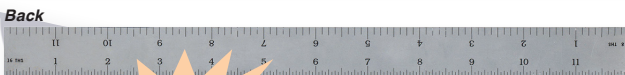
52-330-012-1

NEW!

America Rules

- Made in the USA
- Available in 4R, 5R and IN/MM graduations

GRADUATIONS

- 4R:** 8ths, 16ths, 32nds, 64ths
- 5R:** 32nds, 64ths, 10ths, 100ths
- IN/MM:** 32nds, 64ths, 0.5mm, 1mm

EZ-Read High Contrast Rules

- Hardened stainless steel
- White, microfine graduations against a black background provide a non-glare finish which is extremely easy-to-read

Satin Chrome Rules

- Tempered steel
- Non-glare satin chrome finish
- Sharp easy-to-read graduations

Golden Rules

- Titanium finish = RC80 for superior wear resistance on flat surfaces
- 30% harder finish than standard chrome rules

RIGID STEEL RULES

Order No.	Finish	Size	Reading	List Price	Sale Price
52-307-006-1	Black	6"	5R	\$25.00	22.50
52-307-012-1	Black	12"	5R	40.00	36.00
52-307-018-1	Black	18"	5R	80.00	72.00
52-307-024-1	Black	24"	5R	100.00	90.00
52-330-006-1	Satin Chrome	6"	4R	25.00	22.50
52-330-012-1	Satin Chrome	12"	4R	40.00	36.00
52-380-005-1	Satin Chrome	6"	IN/MM	26.00	23.00

FLEXIBLE STEEL RULES

Order No.	Finish	Size	Reading	List Price	Sale Price
52-297-006-1	Black	6"	4R	\$25.00	22.50
52-297-012-1	Black	12"	4R	40.00	36.00
52-300-006-2	Satin Chrome	6"	5R	25.00	22.50
52-300-012-1	Satin Chrome	12"	5R	40.00	36.00
52-309-006-1	Golden	6"	5R	55.00	49.00
52-309-012-1	Golden	12"	5R	110.00	99.00
52-380-006-1	Satin Chrome	6"	IN/MM	25.00	22.50

Screw Pitch Gages



52-485-051-0

- Narrow designed blades permit use for internal and external screw threads
- Locking device at each end to secure all blades for storage or position
- Correct pitch is determined by matching blade teeth with threads
- Precisely ground and finished
- Blades marked with thread size



Order No.	Description	List Price	Sale Price
52-485-051-0	Inch Screw Pitch Gage with 51 blades: 4 to 84 pitch standard V thread	\$49.22	\$43.00
52-485-018-0	Metric Screw Pitch Gage with 18 blades: 0.50 to 7.0mm center gage with coarse and fine notch included	15.06	13.00
52-485-027-0	In/mm Screw Pitch Gage with 28 blades Inch: 4 to 56 pitch, Metric: 0.50 to 6.00mm	19.99	17.50

American Made Tools!

Electronic Edge Finders

- Six equally spaced light ports provide visibility at any angle
- Edge finder lights instantly when stylus touches work edge
- Repeatability: 0.0002"
- Works on any conductive metal



54-575-625-0



54-575-650-0

Along with light indication, model #54-575-650-0 emits an audible "beep" at time of contact.

Order No.	Stylus	Shank	Audible	Battery	List Price	Sale Price
54-575-625-0	0.200"	1/2"	NO	12 volt	\$138.52	\$115.00
54-575-650-0	0.400"	3/4"	YES	12 volt	138.52	115.00

Rectangular Head Protractor

- Measures angles from 0-180 degrees
- Used to transfer angles and to set bevels
- 6" arm with knurled thumb lock nut
- Made of chrome steel with satin finish
- Measures 3-5/16" x 2". Rectangular head provides four working edges. Blade secured firmly at any angle by a lock joint and knurled nut.



Order No. 52-450-010-0

Sale \$39.00

List \$55.53

TAP-X

Cam-Locking Tap Wrench

3-times the Range of Most Tap Wrenches!

1/8" to 1/2" (3 to 12mm)

QUICK RELEASE CAM!

FAST & TIGHT!

CHANGE TAPS FAST!

- Fits wide range of tap sizes: 1/8" to 1/2" (M3 to M12)
- Patented Revolutionary Cam-Lock System
- Quick-action clamping for easy replacement
- Taps will never release during use
- Heavy-duty design for reliability and long life
- Handles extreme torque
- Can be used as a hand drill for sizes: 1/16" to 5/16"

Order No. 52-492-350-0

Sale \$27.00

List \$33.96



Learn more at ...

You Tube
FowlerVid



Fowler TOOL-A-THON® Vol. 19.3



Find us on social media!

Find us on social media!



Fowler-Bowers **BLUETOOTH** XTH3 Holematic Pistol Grip Sets



BOWERS GROUP



"Fowler-Bowers makes an awesome product!"
T.T.



54-567-050-BT

NOW
available with
ISO Cert.

Contact the Fowler Sales Department
1-800-788-2353

- Self centering 3 point heads above 0.250"
- USB connectivity and Bluetooth
- Resolution: 0.00005"/0.001mm
- IP67 rated
- To reduce hand fatigue, the travel of the Holematic trigger is adjustable for minimum over travel
- Tungsten carbide measuring faces on all 3-point heads from 0.5" (12.5mm) and up
- Sizes over 0.500" (12.5mm) feature blind bore capability
- Includes UKAS certificates for all pistol grip, heads and rings



Contact the Fowler Technical Department for special measuring applications

Order No.	Range	Includes	List Price	Sale Price
54-567-009-BT	0.080" - 0.250"/2 - 6mm (2-point heads)	5 heads, 1 handle, 3 rings	\$6260.07	\$5090.00
54-567-010-BT	0.250" - 0.375"/6 - 10mm	2 heads, 1 handle, 1 ring	2454.58	1995.00
54-567-020-BT	0.375" - 0.750"/10 - 20mm	3 heads, 1 handle, 2 rings	2871.63	2335.00
54-567-050-BT	0.750" - 2" /20 - 50mm	3 heads, 1 handle, 2 rings	3707.86	3015.00
54-567-100-BT	2 - 4"/50 - 100mm	3 heads, 1 handle, 2 rings	4127.04	3355.00
54-567-105-BT	4 - 6"/100 - 150mm	2 heads, 1 handle, 1 ring	3707.86	3015.00
54-567-110-BT	6 - 8" /150 - 200mm	2 heads, 1 handle, 1 ring	4894.29	3980.00
54-567-200-BT	4 - 8" /100 - 200mm	4 heads, 1 handle, 2 rings	7746.82	6300.00
54-567-210-BT	0.750" - 4" - 100mm	6 heads, 1 handle, 4 rings	6034.02	4900.00
54-567-620-BT	0.250" - 0.750" 76 - 20mm	5 heads, 1 handle, 3 rings	3422.40	2780.00
Connectivity Cables/Accessory				
54-115-526-0	Proximity cable with USB connection		\$141.57	\$125.00
54-115-527-0	Proximity cable with serial connection		141.57	125.00
54-115-246-BT	USB bluetooth receiver		50.24	45.00

TOOL-A-THON® Vol. 19.3
Fowler®



Fowler-Bowers **BLUETOOTH** XTD3 Electronic Holemike Sets



BOWERS GROUP



NOW
available with
ISO Cert.

Contact the Fowler Sales Department
1-800-788-2353



Made in
ENGLAND



54-367-110-BT

- Self centering 3 point heads above 0.250"
- USB connectivity and Bluetooth
- Resolution: 0.00005"/0.001mm
- IP67 rated
- Ratchet stop for consistent measurement
- Sizes over 1 1/25mm offer extended travel
- Includes UKAS certificates for micrometer, heads and settings rings

Contact the Fowler Technical Department for special measuring applications

Order No.	Range	Includes	List Price	Sale Price
54-367-000-BT	0.080" - 0.250"/2 - 6mm (2-point heads)	5 heads, 1 handle, 3 rings	\$5705.05	\$4640.00
54-367-010-BT	0.250" - 0.375"/6 - 10mm	2 heads, 1 handle, 1 ring	2377.11	1930.00
54-367-020-BT	0.375" - 0.750"/10 - 20mm	3 heads, 1 handle, 2 rings	2836.61	2300.00
54-367-050-BT	0.750" - 2" /20 - 50mm	3 heads, 1 handle, 2 rings	3852.18	3130.00
54-367-100-BT	2 - 4"/50 - 100mm	3 heads, 1 handle, 2 rings	4265.00	3465.00
54-367-105-BT	4 - 6"/100 - 150mm	2 heads, 1 handle, 1 ring	3600.68	2925.00
54-367-110-BT	6 - 8" /150 - 200mm	2 heads, 1 handle, 1 ring	4756.33	3865.00
54-367-200-BT	4 - 8" /100 - 200mm	4 heads, 1 handle, 2 rings	7515.47	6110.00
Connectivity Cables/Accessory				
54-115-526-0	Proximity cable with USB connection		\$141.57	\$125.00
54-115-527-0	Proximity cable with serial connection		141.57	125.00
54-115-246-BT	USB bluetooth receiver		50.24	45.00

Prices & Specifications are subject to change without notice.

Fowler
TOOL-A-THON® Vol. 19.3



Find us on social media!

Find us on social media!



TOOL-A-THON®

Vol. 19.3

TOOL-A-THON®

TOOL-A-THON®

TOOL-A-THON®

TOOL-A-THON®

TOOL-A-THON®

TOOL-A-THON®

TOOL-A-THON®

Fowler-Bowers XT-Series Holemikes



BOWERS GROUP



52-255-316-0

FREE



Shop Apron
with purchase

The Fowler-Bowers range of mechanical two and three point bore micrometers are now available as XT extended travel holemikes, allowing a wide measurement range without the need to interchange anvils.



Made in ENGLAND



- 3-pt contact with tungsten carbide measuring anvils above 0.5"
- Blind bore measuring heads featured above 0.5"
- Ratchet stop for consistent measuring
- Extensions available for deep measuring
- Includes UKAS certificates for all Holemikes and setting rings

Order No.	Range	Grads.	Accuracy	Meas. Depth	Ring Included	List Price	Sale Price
52-255-310-0	0.250" - 0.312"	0.00025"	0.00015"	2.28"	0.312"	\$737.86	\$508.50
52-255-311-0	0.312" - 0.375"	0.00025"	0.00015"	2.28"	0.312"	683.21	472.50
52-255-312-0	0.375" - 0.500"	0.00025"	0.00015"	2.28"	0.5"	683.21	472.50
52-255-313-0	0.500" - 0.625"	0.00025"	0.00015"	2.44"	0.5"	683.21	472.50
52-255-314-0	0.625" - 0.750"	0.00025"	0.00015"	2.44"	0.75"	700.61	481.50
52-255-315-0	0.750" - 1"	0.00025"	0.00015"	2.60"	0.75"	769.48	531.00
52-255-316-0	1" - 1.375"	0.00025"	0.00015"	2.60"	1.375"	1096.34	756.00
52-255-317-0	1.375" - 2"	0.00025"	0.00015"	3.15"	1.375"	1122.55	774.00
52-255-318-0	2" - 2.625"	0.00025"	0.0002"	3.15"	2.625"	1339.04	927.00
52-255-319-0	2.625" - 3.250"	0.00025"	0.0002"	3.15"	2.625"	1351.02	936.00
52-255-320-0	3.250" - 4"	0.00025"	0.0002"	3.94"	3.25"	1685.52	1165.50

Fowler-Bowers XT-Series Holemike Sets

Order No.	Range	Includes	List Price	Sale Price
52-255-565-0	0.250" - 0.375"	2 heads, 2 handles, 1 ring	\$1638.31	\$1134.00
52-255-665-0	0.375" - 0.750"	3 heads, 3 handles, 2 rings	1865.31	1287.00
52-255-775-0	0.750" - 2"	3 heads, 3 handles, 2 rings	2931.59	2025.00
52-255-885-0	2" - 4"	3 heads, 3 handles, 2 rings	3974.33	2889.00

QUICK CHECK Multi-Function Check Standard

- Accuracy of indicated values $\pm 0.003\text{mm}$
- One compact, multi-function, precise standard
- Can be used to check and verify a multitude of measuring instruments
- Check height gages, calipers, micrometers, depth gages, bore gages, test and dial indicators, caliper gages, protractors, and more ...
- Supplied with a manufacturer's test certificate and fitted wood case
- All sizes marked are actual



Order No. 53-813-015-0

Sale \$1320.00

List \$1677.49

Rapid-Mic Quick-Displacement Electronic Micrometers



54-815-030-C

**WORLD'S FINEST
Micrometer!**



"I have been in the machining business for over 30 years this is by far the best mic I have ever had. One little thing or should I rephrase that, one huge thing, this mic comes with a lifetime warranty... no other company can provide that!"
John T.



Contact the Fowler Sales Department
1-800-788-2353

NEW Bluetooth Ranges NOW Available!

- Position recall
- Delrin quick displacement thimble
- Adjustable measuring force, 5N/10N (54-815-030-0 only)
- Menu customizable with free software
- Non-rotating spindle, 10mm/spindle rotation
- USB output or bluetooth available

LIFETIME WARRANTY



Watch the Demo!
YouTube
FowlerVid



54-815-111-0

Order No.	Description	Max Error	List Price	Sale Price
54-815-030-0	0 - 1.18"/0 - 30mm	0.00012"/0.003mm	\$535.59	\$435.00
54-815-030-C	1.18"/30mm with ISO/A2LA Certification			460.00
54-815-060-0	1.18" - 2.6"/30 - 66mm	0.00016"/0.004mm	792.51	710.00
54-815-100-0	2.6" - 4.0"/66 - 102mm	0.00020"/0.005mm	1108.33	960.00
Set				
54-815-111-0	0 - 4"/0 - 102mm		\$2416.85	\$1995.00
Bluetooth Model				
54-815-130-0	0 - 1.18"/0 - 30mm	0.00012"/0.003mm	\$792.51	\$669.00
54-815-160-0	1.18" - 2.6"/30 - 66mm	0.00016"/0.004mm	1048.72	955.00
54-815-110-0	2.6" - 4.0"/66 - 102mm	0.00020"/0.005mm	1365.00	1199.00
Bluetooth Set				
54-815-112-0	0 - 4"/0 - 102mm		\$2997.39	\$2499.00
Connectivity Cables/Accessory				
54-115-526-0	Proximity cable with USB connection		\$141.57	\$125.00
54-115-527-0	Proximity cable with serial connection		141.57	125.00
54-115-246-BT	USB Bluetooth receiver		50.24	45.00

Prices & Specifications are subject to change without notice.

Fowler

TOOL-A-THON[®] Vol. 19.3



Find us on social media!

Find us on social media!



TOOL-A-THON® Vol. 19.3

Fowler®

Ultra-Cal VI Proximity Electronic Calipers



54-100-444-1

LIFETIME WARRANTY



- IP67 rated
- Ultra-Cal VI technology with proximity cable data output
- Heavy duty frame
- Extra large display
- 12"/300mm is supplied without depth rod

Order No.	Description	Accuracy	Resolution	List Price	Sale Price
54-100-444-1	6"/150mm	0.0008"/20µm	0.0005"/0.01mm	\$161.26	\$140.00
54-100-448-1	8"/200mm	0.0012"/30µm	0.0005"/0.01mm	291.31	250.00
54-100-412-1	12"/300mm	0.0012"/30µm	0.0005"/0.01mm	390.15	350.00
Connectivity Cables					
54-115-526-0	Proximity cable with USB connection			\$141.57	\$125.00
54-115-527-0	Proximity cable with serial connection			141.57	125.00

Ultra-Cal VI Electronic Calipers



54-100-167-0



- IP67 rated
- Available with or without Bluetooth
- Heavy duty frame
- Extra large display
- NOW available with ISO Cert
- 12"/300mm is supplied without depth rod



LIFETIME WARRANTY



Order No.	Description	Accuracy	Resolution	List Price	Sale Price
Without Data Output					
54-100-177-0	6"/150mm	0.0008"/20µm	0.0005"/0.01mm	\$119.65	\$105.00
54-100-178-0	8"/200mm	0.0012"/30µm	0.0005"/0.01mm	244.49	215.00
54-100-179-0	12"/300mm	0.0012"/30µm	0.0005"/0.01mm	327.73	295.00
Bluetooth					
54-100-167-0	6"/150mm	0.0008"/20µm	0.0005"/0.01mm	\$344.36	\$295.00
54-100-167-C	6"/150mm <i>with ISO/A2LA Certification</i>				324.00
54-100-168-0	8"/200mm	0.0012"/30µm	0.0005"/0.01mm	639.48	495.00
54-100-169-0	12"/300mm	0.0012"/30µm	0.0005"/0.01mm	852.07	650.00
Accessory					
54-115-246-BT	USB bluetooth receiver			\$50.24	\$45.00

Micron 0.00005" Electronic Caliper

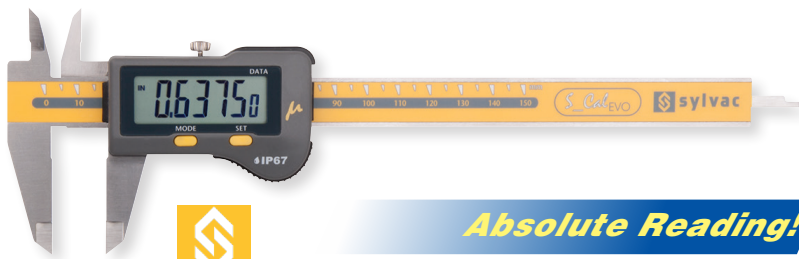

Absolute Reading!

LIFETIME WARRANTY



- Bluetooth connectivity
- High resolution: 0.00005"/0.001mm
- Accuracy up to 4": 0.0006"/0.015mm
- Accuracy above 4": 0.0012"/0.03mm
- Repeatability: 0.00016"/0.004mm
- Heavy duty frame (3.5mm)

Order No.	Description	List Price	Sale Price
54-100-100-0	6"/150mm Micron Electronic Caliper	\$400.07	\$325.00
Accessory			
54-115-246-BT	USB bluetooth receiver	\$50.24	\$45.00

Ultra-Cal V Electronic Calipers

Buy 5, Get 1 FREE!



54-100-067-1

- 4-way measurement, inside, outside, depth and step (6" & 8" models)
- Hardened stainless steel construction
- Direct RS232 output
- Features Absolute/Relative Measuring Modes
- Thumbroll (6" and 8" models only)
- NOW available with ISO Cert
- 12"/300mm is supplied without depth rod

LIFETIME WARRANTY



Order No.	Description	Accuracy	Resolution	List Price	Sale Price
54-100-667-0	Buy 5 standard 6"/150mm Electronic Calipers (54-100-067-1), Get 1 FREE			\$1033.05	\$825.00
54-100-067-1	6"/150mm	0.0008"/20µm	0.0005"/0.01mm	\$206.61	\$165.00
54-100-067-C	6"/150mm with ISO/A2LA Certification				194.00
54-100-068-1	8"/200mm	0.0012"/30µm	0.0005"/0.01mm	491.87	370.00
54-100-069-1	12"/300mm	0.0012"/30µm	0.0005"/0.01mm	590.24	490.00
Connectivity Cables					
54-115-526-0	Proximity cable with USB connection			\$141.57	\$125.00
54-115-527-0	Proximity cable with serial connection			141.57	125.00

Prices & Specifications are subject to change without notice.



Find us on social media!



Multimode Electronic Test Indicators

The QuadraTest is the perfect solution to test indicating applications

- 4 measuring modes: Min, Max, TIR and Direct
- 4 measuring resolutions - 0.00005"/0.001mm or 0.0005"/0.01mm
- Water, oil and coolant resistant to IP65
- 1-1/2" diameter dial face rotates a full 360°
- Bar graph and numeric digital display
- Meets or exceeds DIN/ISO Standards (Maximum error on .00005" scale at full range: 0.0004")
- Available with 1/2" or extra-long 1-7/16" contact point



54-562-777-0

Order No.	Range	Contact Point Length	List Price	Sale Price
54-562-777-0	0.040"/1mm	1/2"	\$355.00	\$320.00
54-562-888-0	0.020"/0.5mm	1-7/16"	385.00	\$345.00
Accessory				
54-115-528-0	Output Cable USB		\$240.47	\$220.00

IP65 Mini-Resistant Electronic Indicators

- Coolant, water & oil resistant to IP65 specifications!
- Non-contact measuring system!
- Tough carbide contact point!

- Range: 0 - 0.5"/12.5mm
- High contrast LCD display
- Floating zero
- Preset & Hold features
- Menu customizable with free software
- Dual measuring references
- Dovetail back with lug
- 1.575" diameter bezel



54-520-680-3

Order No.	Description	Maximum Error	Resolution	List Price	Sale Price
54-520-680-2	0 - 0.5"/12.5mm	0.0004"/0.01mm	0.0005"/0.01mm	\$411.22	\$370.00
54-520-680-3	0 - 0.5"/12.5mm	0.0002"/0.005mm	0.00005"/0.001mm	597.67	\$535.00
Connectivity Cables					
54-115-444-0	Output cable RS 232			\$185.05	\$165.00
54-115-528-0	Output Cable USB			240.47	\$220.00

LIFETIME WARRANTY

We are so confident that these Fowler-Sylvac Mark VI electronic indicators are the most accurate, most dependable, best made products you can buy, we are extending the warranty to last a lifetime!

Quality, accuracy, dependability, world-class customer service and now a real Lifetime Warranty!

Mark VI Electronic Indicators

- Robust construction
- Repeatability: 2µm
- Output: Proximity/Power - USB/RS232/digimatic/Wireless
- Menus customizable with free software
- Wide range of functions (MIN/MAX/DELTA, TOL, Factor, Preset, Auto Off, etc)
- Bezel rotates 270°
- Large display with LED tolerance indicators
- Includes lug back

*NO Gimmicks
NO Hurdles
NO Nonsense*



54-530-135-0



NOW
available with
ISO Cert.

Contact the Fowler Sales Department
1-800-788-2353



54-530-535-0

Learn more at ...
YouTube
FowlerVid



Order No.	Description	Maximum Error	Resolution	List Price	Sale Price
54-530-125-0	0 - 0.500"/12.5mm	0.0004"/0.01mm	0.0005"/0.01mm	\$448.16	\$395.00
54-530-135-0	0 - 0.500"/12.5mm	0.00012"/0.003mm	0.00005"/0.001mm	573.85	499.00
54-530-145-0	0 - 1"/25mm	0.0004"/0.01mm	0.0005"/0.01mm	511.50	450.00
54-530-155-0	0 - 1"/25mm	0.00016"/0.004mm	0.00005"/0.001mm	612.11	540.00
54-530-155-C	0 - 1"/25mm with ISO/A2LA Certification				565.00
54-530-175-0	0 - 2"/50mm	0.00019"/0.005mm	0.00005"/0.001mm	\$1158.63	1015.00
Bluetooth					
54-530-335-0	0 - 0.500"/12.5mm	0.00012"/0.003mm	0.00005"/0.001mm	\$710.48	\$620.00
54-530-355-0	0 - 1"/25mm	0.00016"/0.004mm	0.00005"/0.001mm	759.72	665.00
Accessory					
54-115-246-BT	USB Bluetooth Receiver			\$50.24	\$45.00
Analog Display					
54-530-535-0	0 - 0.500"/12.5mm	0.00012"/0.003mm	0.00005"/0.001mm	\$644.90	\$565.00
54-530-555-0	0 - 1.00"/25mm	0.00016"/0.004mm	0.00005"/0.001mm	705.06	575.00

Prices & Specifications are subject to change without notice.



Find us on social media!





Find us on social media!



Fowler - Sylvac Hi_Cal Electronic Height Gages

- Extra low measuring force, from 0.2N
- Measure internal and external diameters, centerlines, heights, widths, depths and MIN/MAX/TIR capability
- Excellent repeatability thanks to the motorized carriage
- High reliability
- Data output USB and RS232
- Battery life: 40 hours rechargeable during operation
- Touch sensitive probe speed for easy operation
- Base with small footprint
- Includes: protective cover, charging set, ruby ball probe Ø3mm, setting gage and calibration certificate



Contact the Fowler Sales Department
1-800-788-2353



54-931-150-0

Accessory Probe Sets



54-930-215-0



Swiss Quality!



54-930-217-0

FREE 1mm Ball Probe with

Order No.	Range
54-931-150-0	6"/150mm
54-931-150-C	6"/150mm <i>with ISO/A2LA Certification</i>
54-931-300-0	12"/300mm
54-931-300-C	12"/300mm <i>with ISO/A2LA Certification</i>
54-931-450-0	17.5"/450mm
54-931-450-C	17.5"/450mm <i>with ISO/A2LA Certification</i>
Accessories	
54-930-215-0	Full Probe Accessory Set
54-930-217-0	Basic Probe Accessory Set



54-931-300-0



54-931-450-0

FREE Basic Probe Set
with 54-931-450-0 Hi_Cal Purchase
\$617.62 Value!

6"/150mm & 12"/300mm Hi_Cal Purchase

Accuracy	List Price	Sale Price
0.00013"/0.0034mm	\$4849.82	\$4300.00
0.00016"/0.0042mm	5573.46	4550.00
0.00020"/0.005mm	6093.03	5015.00
		5365.00
		5475.00
		5825.00
	\$1138.15	\$1025.00
	617.62	555.00

Prices & Specifications are subject to change without notice.

Fowler

TOOL-A-THON® Vol. 19.3



Find us on social media!

Find us on social media!



Fowler - Trimos V3 Electronic Height Gages

The Fowler-Trimos V3 vertical measuring instruments have been developed for the most difficult workshop environments. Manufactured in their entirety in Switzerland, they guarantee a robust, precise and reliable product in the long run.

- "Black mask" display with user friendly functions
- Electronically adjustable measuring force 0.75/1.5 (N)
- Lithium-ion rechargeable batteries
- All adjustments possible without tools
- Cast iron base for optimal stability
- RS232 and USB interfaces requires 54-192-112-0 cable
- Carriage displacement: Manual
- Measures heights, diameters, perpendicularity, centerlines, Min/Max/Delta
- Resolution: 0.00005"/0.001mm
- Repeatability (2s): 0.00008"/0.002mm (Ø) 0.00016"/0.004mm)



All V Models Include:

- Charging unit
- Measuring insert with ruby ball Ø4mm
- Probe holder elbow Ø 8mm
- Setting gage
- User's manual and test certificate



FREE



Shop Apron
with purchase



54-192-340-0



Contact the Fowler Sales
Department 1-800-788-2353

V3	54-192-340-0	54-192-370-0
Measuring Range	16"/407mm	28"/711mm
Range with Probe inverted	20"/508mm	31.9"/812mm
Max. Permissible Errors	0.00028"/0.007mm	0.00032"/0.008mm
Frontal Squareness Deviation	0.0004"/0.010mm	0.0006"/0.015mm
Air Cushion		NO

Order No.	Description	Range	List Price	Sale Price
54-192-340-0	V3 Height Gage	16"/407mm	\$4543.03	\$3800.00
54-192-370-0	V3 Height Gage	28"/711mm	5008.90	4505.00
Probe Sets				
54-199-105-0	4mm Probe Set, 21 piece		\$1747.81	\$1540.00
54-199-106-0	8mm Probe Set, 16 piece		1304.22	1200.00
54-199-107-0	Economy Probe Set, 7 piece		462.98	424.00
Accessories				
54-199-400-0	12"/300mm Holder - for 8mm probes		\$978.33	\$850.00
54-777-120-0	Vmux software - for connecting multiple units to one PC		460.80	390.00

Fowler - Trimos Mini Horizontal

Calibration System

This economically priced set allows you to easily calibrate internal and external setting standards as well as measure parts up to 4" OD and as small as 0.24" ID.

The Fowler-Trimos Mini Horizontal Special includes the Trimos Mini Horizontal and the Sylvac Nano Indicator with Bluetooth. Includes everything to get started! Additional accessories available, contact our technical department 800-788-2353.

 **TRIMOS**



Order No: 53-190-012-TP

\$7,565.⁰⁰

List \$8,409.65



Mini-Horizontal

- Internal range: 0.24" - 4" / 6 - 100mm
- External range: 0 - 4" / 0 - 100mm
- Resolution: 0.00001" / 0.0001mm
- Accuracy: 0.00008" / 0.0022mm
- Monoblock construction with probe guide track
- Adjustable end-stop with anvil location
- Control knob for the displacement of the guide track of the monoblock (probe release)
- Adjustable measuring pressure
- Adjustable measuring table

Mark VI NANO Electronic Indicator

- Range: 1" / 25mm
- Resolution: 0.00001" / 0.0001mm
- Accuracy: 0.00008" / 0.0022mm
- Repeatability: 0.00002" / 0.0005mm
- Lifetime warranty
- Large display
- Bluetooth
- IP54 rated

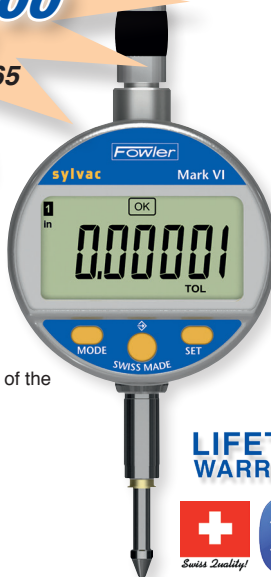

LIFETIME WARRANTY



Fowler

TOOL-A-THON® Vol. 19.3



Find us on social media!





Tool Presetter

Quick checking of heights and diameters (radius) of all kinds of tools such as ISO, BT, HSK, VDIA etc. is guaranteed by a fixed precise steel measuring column with displacement devices in coordinates (X/Z) and constant measuring force.

Tool Holding Spindle

Tool presetter is supplied with high precision imported ball cage bearing (Grade 0).

High precision spindle has:

- Less than 2 μm concentricity error



NEW!

Display

- MIN/MAX function
- 2 reference indications
- Measuring value display
- Function for PRESET value and TOLERANCE value inputs
- Tolerance mode indication
- Measuring unit (MM/INCH) indication
- Low battery warning indication
- Display hold
- Output - OPTO RS232 for each axis
- Floating zero function
- Carbide measuring insert
- Accepts measuring probes with 8mm shank

FREE



Shop Apron

with purchase of 54-188-300-0

Additional Features

- Counter balanced measuring carriage
- Constant measuring force of horizontal measuring arm ensures high accuracy
- High precision Sylvac measuring system

Applications



Height Measurement



Diameter/Radius Measurements



Checking of a Runout

Order No.	Description	List Price	Sale Price
54-188-300-0	Tool Presetter	\$9950.00	\$9450.00
54-121-000-0	ISO 50/45 Tool Pot Adaptor	1120.00	
54-121-005-0	ISO 50/40 Tool Pot Adaptor	615.00	
54-121-010-0	ISO 50/35 Tool Pot Adaptor	1120.00	
54-121-015-0	ISO 50/30 Tool Pot Adaptor	870.00	
54-188-333-0	ISO 50 Setting Gage	500.00	
54-188-335-0	ISO 40 Setting Gage	450.00	

Z-CHECK 54 PLUS+

Z-Axis Tool Setter

- Supplied with zero reference setting block
- Easy to read super large display
- Back light turns on when zero reference is achieved
- IP54 protected for fluid and coolant resistance
- 4 magnets embedded into base
- 2" default setting height
- Steel contact surface with 0.0002" flatness
- Range: 0.12"/3mm
- Resolution: 0.00005"/0.001mm
- Repeatability: 0.00015"/0.004mm
- Accuracy: 0.0001"/0.003mm
- Uses 1 3V CR2032 battery
- Includes a rugged, aluminum fitted case



NEW!

Order No. 54-188-200-0

Sale \$99.00

List \$112.15

HIGH Accuracy Z-Axis Detectors

NEW!



54-188-140-0

For use in CNC Machines and other applications where high accuracy is required!



- High accuracy and repeatability, $\pm 0.000039"/0.001\text{mm}$
- IP67 protection
- Carbide touch surface (0.196"/5mm)
- High precision bearing guide system for long life
- Interchangeable magnetic base
- High visibility LED indicator
- Movement stroke 0.078"/2mm
- Trigger force: 54-188-140-0, 1.0N (3.6 oz./100g)
54-188-150-0, 0.5N (1.8 oz./50g)
- Operation temperature +5°C to 50°C (40°F to 120°F)
- Uses 2, 1.5V batteries (SR44 or LR44)
- Battery life approximately 250 hours (on time)

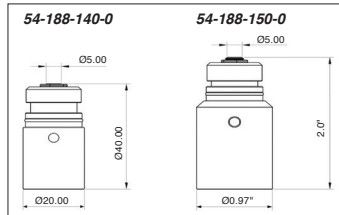

Order No.	Model	Dimensions	List Price	Sale Price
54-188-140-0	Metric	Height: 1.57"/40mm, Dia. 0.78"/20mm	\$265.00	\$240.00
54-188-150-0	Inch	Height: 2"/50.8mm, Dia. 0.97"/24.638mm	265.00	240.00

Prices & Specifications are subject to change without notice.



Find us on social media!



TOOL-A-THON® Vol. 19.3
Fowler®

Fowler/Mirage Tool Set

patent pending

The Fowler/Mirage Tool Set is an easy and affordable way to set Z depths quickly and accurately!

- Can be operated directly off table or from machine vise
- Aluminum contact face eliminates carbide chipping on cutting tools
- Works on any conductive materials
- Repeatability: .0002"
- Block dimensions: 1" x 2" x 3" (nominal)
- Batteries included

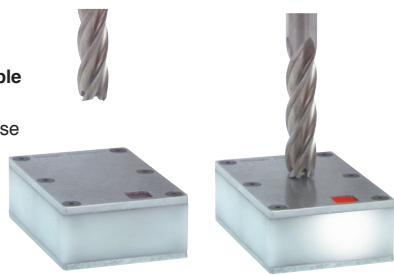

Slowly lower cutting tool toward Tool Set...

...indicator will light up upon contact!

Order No. 54-575-750-0

Sale \$75.00 List \$106.00

COAX-2D 2 Dimensional Coaxial Indicator Set - Inch

Use the 2D Coaxial Set for accurate component centering and positioning in most machining applications. The dial remains stationary during the rotation of the machine spindle.

- Indicator assembly with 1.6" (42.5mm) diameter dial
- Graduations and revolution counter 0.0005" (.01mm)
- 3 Internal and 3 External feelers
- Center point feeler
- Restraining arm



Specifications:

- Length: 6-7/8" (175mm)
- Shank: 3/8" dia. x 7/8" (10mm x 20mm) long
- Feeler ball: 1/8" (3mm) dia.
- Dial readings: 0-50
- Measuring range: 0.250" (6mm) axis offset
- Speed—recommended not to exceed approx. 800 RPM
- Repeatability to within 0.0002" (0.005mm) of true center
- Capacity depends on feelers installed, but overall range is 5/32-12" (4-300mm) internal diameter; 0-12" (0-300mm) external diameter

Order No. 52-710-025-0

Sale \$199.00 List \$253.62

Edge Finder Set

Contains:

- shank tip
- 3/8" x 0.200" edge finder
- 1/2" x 0.200" edge finder
- 1/2" x 0.200" combo edge finder
- 1/2" x 0.500" edge finder
- Complete in fitted case



Order No. 52-575-125-0

Sale \$44.00 List \$51.98

Machinist Grade Dial Calipers



52-008-706-0



- 4-way measuring
- Solid stainless steel construction
- 0.100"/2mm range per revolution
- 0.001"/0.02mm reading dial face
- Tough shockproof gearing

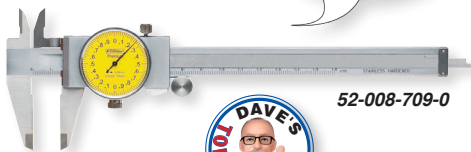

52-008-709-0



"Very precise with consistent readings. I would never change this analog for a digital one"
Erick T.

Order No.	Range	Dial Face Color	Accuracy	List Price	Sale Price
52-008-706-0	0 - 6"	White	± 0.001"	\$81.60	\$67.00
52-008-707-0	0 - 6"	Black	± 0.001"	81.60	67.00
52-008-708-0	0 - 8"	White	± 0.0015"	99.57	85.00
52-008-712-0	0 - 12"	White	± 0.002"	131.81	98.00
52-008-709-0	0 - 150mm (Metric Model)	Yellow	± 0.02mm	81.60	68.00

0 - 6" Dial Calipers

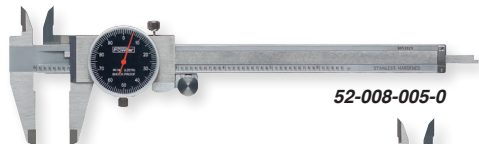

52-008-005-0

- 4-way measuring
- Covered rack
- Accuracy ± 0.001"
- 0.100" per revolution
- Dial graduation: 0.001"
- Hardened stainless steel rack

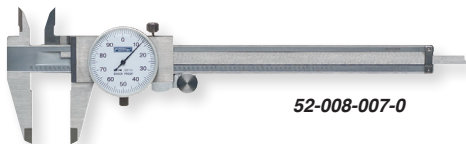

52-008-007-0

Order No.	Range	Dial Face Color	Accuracy	List Price	Sale Price
52-008-005-0	0 - 6"/150mm	Black	± 0.001"	\$93.33	\$67.00
52-008-007-0	0 - 6"/150mm	White	± 0.001"	86.70	67.00

Vernier Calipers

- Made of fully hardened stainless steel; microfine black graduations on a satin chrome finish for easy, precise reading
- All models offer a depth rod which can be read directly from verniers
- Measuring faces are ground and lapped for extreme accuracy
- 4-way jaws for outside, inside, depth and step measurements
- All sliding surfaces are raised to prevent defacement and wear of graduations

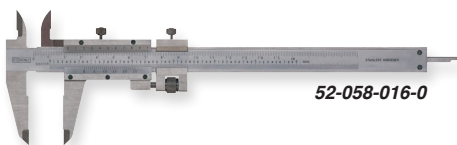

52-058-016-0

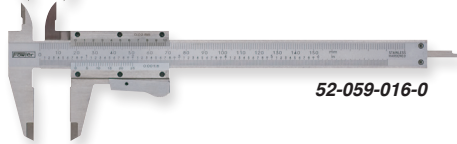

52-059-016-0

Order No.	Range	Graduation	Depth of Jaws	List Price	Sale Price
Vernier Caliper with Fine Adjustment					
52-058-016-0	0 - 6"/0 - 150mm	0.001"/0.02mm	1.6"	\$51.69	\$41.00
Vernier Caliper with Thumb Lock					
52-059-016-0	0 - 6"/0 - 150mm	0.001"/0.02mm	1.6"	46.68	37.00



Find us on social media!



XTRA-RANGE[®] Electronic Calipers

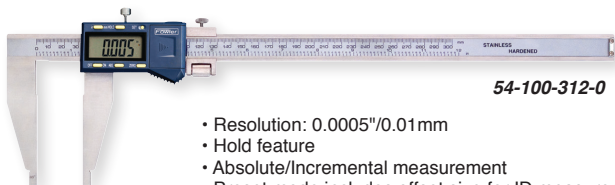

54-100-312-0

- Resolution: 0.0005"/0.01mm
- Hold feature
- Absolute/Incremental measurement
- Preset mode includes offset size for ID measurements
- All sizes feature fine adjustment screw
- Includes shop hardened case



Order No.	Range	Accuracy	Jaw Depth	List Price	Sale Price
54-100-312-0	12"/300mm	± 0.002"	3.5"	\$228.87	\$185.00
54-100-024-1	24"/600mm	± 0.003"	4"	333.33	290.00
54-100-042-1	40"/1000mm	± 0.004"	4.9"	1116.90	830.00

Heavy Duty Dial Caliper with Cross Jaws

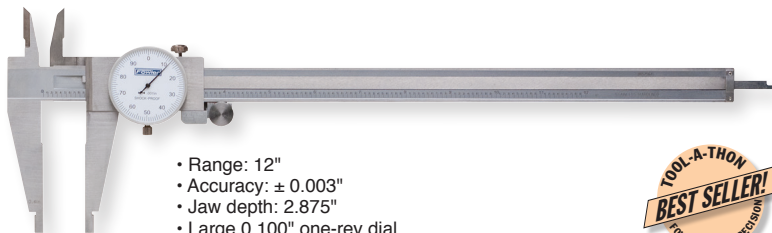

- Range: 12"
- Accuracy: ± 0.003"
- Jaw depth: 2.875"
- Large 0.100" one-rev dial
- Depth rod
- 4-way measurement
- Cross-jaws for direct internal measurement
- Stainless steel, satin chrome finish



Order No. **52-025-112-0**

Sale \$167.00

List \$209.98

Extended Range Dial Calipers



52-008-018-0

- Graduations: 0.001"
- Jaw depth: 3.375"
- Stainless steel construction
- Satin chrome finish
- Depth rod
- 0.500" internal measuring nibs



Order No.	Range	Accuracy	Jaw Depth	List Price	Sale Price
52-008-018-0	18"	± 0.003"	3.125"	\$262.22	\$215.00
52-008-024-0	24"	± 0.003"	3.375"	317.75	250.00

TOOL-A-THON[®] Vol. 19.3

Fowler[®]

FLIP PLUS *Electronic Calipers*



54-200-506-0

The Flip Display allows
RIGHT or LEFT handed operation!

- Display flips 180° with display rotation function for true left handed operation
- Can also be positioned for top viewing
- Available in 6", 8" and 12" models
- 4-way measuring - OD, ID, depth and step
- Stainless steel frame
- Thumbroll for smooth measuring
- Heavy duty frame is 0.140"/3.5mm thick
- Direct inch/metric conversion
- Resolution 0.0005"/0.01mm
- Floating zero
- Includes fitted case

Left-Handed View



Top View



Order No.	Range	Accuracy	List Price	Sale Price
54-200-506-0	0 - 6"/150mm	± 0.0012"/0.03mm	\$93.59	\$79.00
54-200-508-0	0 - 8"/200mm	± 0.0012"/0.03mm	114.39	95.00
54-200-512-0	0 - 12"/300mm	± 0.0016"/0.04mm	145.61	120.00

Master Vernier Caliper

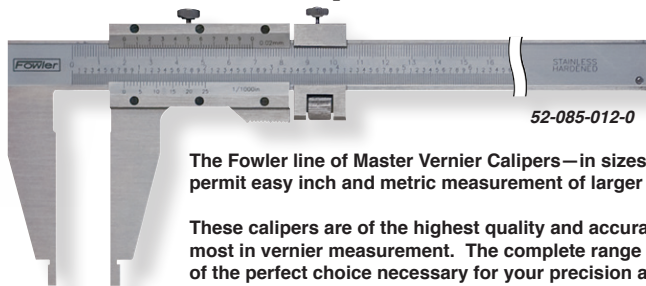

52-085-012-0

The Fowler line of Master Vernier Calipers—in sizes up to 40"/1000mm—permit easy inch and metric measurement of larger workpieces.

These calipers are of the highest quality and accuracy to ensure the utmost in vernier measurement. The complete range of sizes assures you of the perfect choice necessary for your precision applications.

- Satin chrome finish on all models
- Hardened stainless steel throughout; ground and lapped for accuracy
- Extra long vernier scales have wide spaced microfine graduations on satin chrome finish to ensure easy reading
- Machine divided and engraved from master for exceptional accuracy
- A raised sliding surface prevents wear and defacement of microfine graduations
- Verniers are adjustable for wear
- Open face design permits both vernier scales to be located on one side of the gage for both inside and outside measurements
- All sizes permit inside and outside measurements
- For larger workpieces, the long jaws permit greater accessibility and easier measurements
- All sizes meet or exceed U.S. Federal specifications for accuracy
- Includes case

Order No.	Range	Graduation	Jaw Depth	List Price	Sale Price
52-085-012-0	12"/300mm	0.001"/0.02mm	3"	\$109.24	\$89.00
52-085-024-0	24"/600mm	0.001"/0.02mm	4"	187.27	161.00
52-085-040-0	40"/1000mm	0.001"/0.02mm	5-1/2"	623.20	499.00

Prices & Specifications are subject to change without notice.

21

Fowler®

TOOL-A-THON® Vol. 19.3



Find us on social media!



IP67 PLUS+

Electronic Calipers with Smart Wireless Communication



IP67

**IP67 &
Smart Wireless
All in one!**

- **NEW** HID Interface allows connection to most bluetooth enabled devices
- **Extra** battery tray and 1" standard included
- Supplied with NIST certification
- Heavy duty frame with 4 way measuring
- Super large display
- Wireless in a value priced electronic caliper
- Protected to IP67

Order No.	Range	Accuracy	List Price	Sale Price
54-100-554-BT	NEW 0 - 4"/100mm	0.001"/0.02mm	\$180.00	\$160.00
54-100-556-BT	NEW 0 - 6"/150mm	0.001"/0.02mm	185.00	165.00
54-100-558-BT	NEW 0 - 8"/200mm	0.0015"/0.04mm	225.00	200.00
54-100-512-BT	NEW 0 - 12"/300mm	0.0015"/0.04mm	240.00	215.00

EURO-CAL IV® Electronic Calipers



INCH • METRIC • FRACTION™

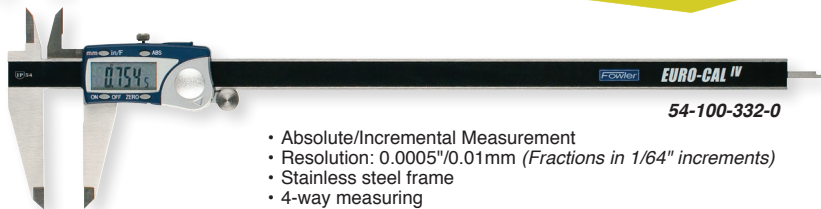

- Absolute/Incremental Measurement
- Resolution: 0.0005"/0.01mm (Fractions in 1/64" increments)
- Stainless steel frame
- 4-way measuring

Order No.	Range	Accuracy	List Price	Sale Price
54-100-330-1	6"/150mm	± 0.001"/0.02mm	\$132.21	\$102.00
54-100-331-0	8"/200mm	± 0.001"/0.02mm	156.52	123.00
54-100-332-0	12"/300mm	± 0.0015"/0.03mm	200.78	164.00

Water Resistant IP54 Electronic Calipers

Absolute Reading!



54-100-777-2

- Absolute sensor technology
- 4-way measuring
- Stainless steel frame
- Resolution: 0.0005"/0.01mm



Order No.	Range	Accuracy	List Price	Sale Price
54-100-777-2	0 - 6"/150mm	0.0015"/0.04mm	\$145.50	\$105.00
54-100-712-2	0 - 12"/300mm	0.0015"/0.04mm	211.67	147.00
Accessory				
54-115-100-0	Wireless Transmitter		\$110.76	\$95.00

Digital Calipers



54-100-004-2

Absolute Reading!

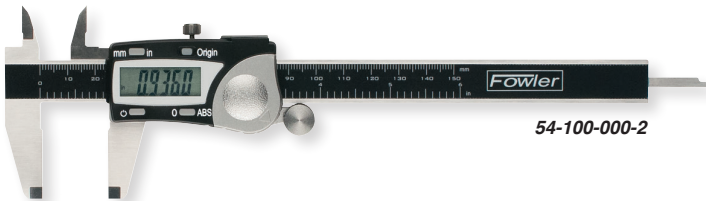

54-100-000-2



- Absolute sensor technology
- Stainless steel frame
- 4-way measuring
- Resolution: 0.0005"/0.01mm

Order No.	Range	Accuracy	List Price	Sale Price
54-100-004-2	0 - 4"/100mm	0.001"/0.02mm	\$111.12	\$84.00
54-100-000-2	0 - 6"/150mm	0.001"/0.02mm	129.57	96.00
54-100-008-2	0 - 8"/200mm	0.0015"/0.04mm	152.15	121.00
54-100-112-2	0 - 12"/300mm	0.0015"/0.04mm	198.36	162.00
Accessory				
54-115-100-0	Wireless transmitter		\$110.76	\$95.00



Find us on social media!



XTRA-VALUE^{Plus} Electronic Calipers

INCH • METRIC • FRACTIONTM



54-103-006-0



- Inch/Metric/Fraction reading: 0.0005"/0.01mm/ 1/128"
- Dust, water and oil resistant to IP54 standards making it **great for shop environments**
- Heavy Duty frame for extra rigidity and wear
- Super large, easy to read 14 x 52mm display
- Combined thumbrest and thumbroll for fine adjustment

Order No.	Range	Resolution	Accuracy	List Price	Sale Price
54-103-006-0	0 - 6"/150mm	0.0005"/0.01mm	± 0.001"/0.02mm	\$79.11	\$64.00
54-103-012-0	NEW 0 - 12"/300mm	0.0005"/0.01mm	± 0.0015"/0.04mm	135.00	120.00

XTRA-VALUE CAL[®] Electronic Calipers

Buy a 12" Get a 6" FREE

Buy a 12" (54-101-300-1) at **list price** and get a 6" (54-101-150-2) **FREE**



54-101-300-1

"Great price, good quality, prompt processing"
Terri F.



54-101-150-2

- Accuracy: 0.001"/0.02mm (6" models)
- Stainless steel frame
- Large easy-to-read display
- Resolution: 0.0005"/0.01mm
- Absolute/Incremental Measurement
- 4-way measuring



Order No.	Range	Display Type	List Price	Sale Price
54-101-300-P	Buy a 12" (54-101-300-1) and Get a 6" (54-101-150-2) FREE		\$152.05	\$101.33
54-101-150-2	6"/150mm	Regular Display - includes FREE NIST Cert.	50.72	41.00
54-101-600-1	6"/150mm	Super Large Display with hold feature	66.16	52.00
54-101-200-1	8"/200mm	Regular Display	79.36	66.00
54-101-800-1	8"/200mm	Super Large Display with hold feature	99.18	78.00
54-101-300-1	12"/300mm	Regular Display - includes FREE NIST Cert.	101.33	84.00
54-101-900-1	12"/300mm	Super Large Display with hold feature	132.44	112.00

TOOL-A-THON[®] Vol. 19.3



XTRA-VALUE II Electronic Micrometers

Fowler®

TOOL-A-THON® Vol. 19.3



54-870-001-0



- Resolution: 0.00005"/0.001mm
- Carbide measuring faces
- Absolute and incremental modes
- Ratchet thimble

Order No.	Range	Accuracy	List Price	Sale Price
54-870-001-0	0 - 1"/0 - 25mm	± 0.00016"	\$99.18	\$77.00
54-870-002-0	1 - 2"/25 - 50mm	± 0.00016"	107.10	84.00
54-870-003-0	2 - 3"/50 - 75mm	± 0.0002"	121.38	90.00
54-870-004-0	3 - 4"/75 - 100mm	± 0.0002"	135.66	102.00

Electronic Coolant Resistant Micrometers



54-860-001-1



- Protected to IP54 specifications
- Automatic switch off
- Resolution: 0.00005"/0.001mm
- Carbide measuring faces
- Absolute & incremental modes

Order No.	Range	Accuracy	List Price	Sale Price
54-860-001-1	0 - 1"/0 - 25mm	± 0.00016"	\$125.67	\$99.00
54-860-002-1	1 - 2"/25 - 50mm	± 0.00016"	145.50	114.00
54-860-003-1	2 - 3"/50 - 75mm	± 0.0002"	158.69	124.00
54-860-004-1	3 - 4"/75 - 100mm	± 0.0002"	184.17	142.00
54-860-005-1	4 - 5"/100 - 125mm	± 0.00024"	206.28	159.00
54-860-006-1	5 - 6"/125 - 150mm	± 0.00024"	231.51	175.00
Set				
54-860-103-1	0 - 3"/0 - 75mm Set		\$413.37	\$310.00



Find us on social media!
 f
 E
 in
 You Tube



XTRA-MIC PLUS+ Electronic Micrometers



54-880-001-0

Great for Shop Environments!

- Corrosive resistant ratchet thimble (anodized aluminum)
- Super large LCD display, 14mm height
- Resolution: 0.00005"/0.001mm
- IP54 protected against fluid and dust
- Spindle lock
- Carbide tipped anvil and spindle
- SPC output
- Includes fitted case



Order No.	Range	Accuracy	List Price	Sale Price
54-880-001-0	NEW 0 - 1"/0 - 25mm	0.00016"/0.004mm	\$140.76	\$124.00
54-880-002-0	NEW 1 - 2"/25 - 50mm	0.00016"/0.004mm	162.18	142.00
54-880-003-0	NEW 2 - 3"/50 - 75mm	0.0002"/0.005mm	173.40	152.00
54-880-004-0	NEW 3 - 4"/75 - 100mm	0.0002"/0.005mm	198.90	174.00
Set				
54-880-103-0	NEW 0 - 3"/0 - 75mm		\$447.78	\$390.00
Accessory				
54-520-399-0	SPC cable		\$170.22	\$120.00

Thread Measuring Wire Set

- Includes 48 wires in 16 different sizes
- **NOW includes wire holders**
- Accuracy for sizes 0.018" through 0.108" is within +0 / -0.0004"; sizes 0.120" through 0.185" is within +0 / -0.0005"
- Measures all U.S. 60° threads from 3 - 48 threads per inch



Order No. **52-485-048-0**

Sale \$24.00 List \$31.48

Electronic IP54 Ball Anvil Micrometers



54-860-113-1

Absolute Reading!



- Ball anvil/flat spindle for measuring tubes or the insides of holes to outer edges
- Protected to IP54 specifications
- Large LCD display, 8.5mm
- Automatic switch off

- Resolution: 0.00005"/0.001mm
- Hardened steel measuring face
- Absolute & incremental modes
- Sizes over 1"/25mm include standard

Order No.	Range	Accuracy	List Price	Sale Price
54-860-113-1	0 - 1"/0 - 25mm	0.00016"/0.004mm	\$127.36	\$99.00
54-860-114-1	1 - 2"/25 - 50mm	0.00016"/0.004mm	149.18	115.00
54-860-115-1	2 - 3"/50 - 75mm	0.0002"/0.005mm	171.33	131.00
54-860-116-1	3 - 4"/75 - 100mm	0.0002"/0.005mm	193.04	147.00

Electronic IP54 Ball Anvil & Spindle Micrometers



54-860-211-1

Absolute Reading!



- Ball anvil and spindle for measuring special curved surfaces
- Protected to IP54 specifications
- Large LCD display, 8.5mm
- Automatic switch off

- Resolution: 0.00005"/0.001mm
- Hardened steel measuring face
- Absolute & incremental modes
- Sizes over 1"/25mm include standard

Order No.	Range	Accuracy	List Price	Sale Price
54-860-211-1	0 - 1"/0 - 25mm	0.00016"/0.004mm	\$138.81	\$108.00
54-860-212-1	1 - 2"/25 - 50mm	0.00016"/0.004mm	160.19	123.00
54-860-213-1	2 - 3"/50 - 75mm	0.0002"/0.005mm	183.02	140.00
54-860-214-1	3 - 4"/75 - 100mm	0.0002"/0.005mm	206.85	158.00

Fowler®

TOOL-A-THON® Vol. 19.3



Find us on social media!

Outside Inch Micrometers

Find us on social media!
 YouTube
 LinkedIn
 Facebook
 Twitter



52-240-001-1



FREE



Shop Apron
 with purchase of ANY SET



52-215-003-1

- Microfine graduations on satin chrome finish and carbide tipped measuring faces
- Diameter of measuring faces: 0.256"
- Graduation: 0.0001"
- Flatness: 0.00003"
- Positive lever locking clamp
- Spindle thread hardened, ground and lapped for ultimate accuracy
- Anvil & spindle hardened and precision ground with microlap finish on tips
- Includes a wrench and case

Order No.	Range	Accuracy	Thimble	List Price	Sale Price
52-240-001-1	0 - 1"	± 0.00015"	Friction	\$42.43	\$33.00
52-240-101-1	0 - 1"	± 0.00015"	Ratchet	42.43	33.00
52-240-002-1	1 - 2"	± 0.00015"	Friction	49.33	38.00
52-240-102-1	1 - 2"	± 0.00015"	Ratchet	49.33	38.00
52-240-003-1	2 - 3"	± 0.0002"	Ratchet	57.65	45.00
52-240-004-1	3 - 4"	± 0.0002"	Ratchet	64.41	50.00
52-240-005-1	4 - 5"	± 0.00025"	Ratchet	71.31	55.00
52-240-006-1	5 - 6"	± 0.00025"	Ratchet	78.20	61.00
52-240-007-1	6 - 7"	± 0.0003"	Ratchet	84.98	66.00
52-240-008-1	7 - 8"	± 0.0003"	Ratchet	100.07	78.00
52-240-009-1	8 - 9"	± 0.0003"	Ratchet	113.74	89.00
52-240-010-1	9 - 10"	± 0.0003"	Ratchet	128.96	101.00
52-240-011-1	10 - 11"	± 0.00035"	Ratchet	142.63	111.00
52-240-012-1	11 - 12"	± 0.00035"	Ratchet	156.29	122.00
Sets					
52-215-003-1	0 - 3" with standards and fitted shop hardened case			\$148.00	\$110.00
52-215-004-1	0 - 4" with standards and fitted shop hardened case			212.00	164.00
52-215-006-1	0 - 6" with standards and fitted wooden case			360.00	280.00
52-215-012-1	0 - 12" with standards and fitted wooden case			1091.33	810.00
52-215-612-1	6 - 12" with standards and fitted wooden case			720.00	560.00

TOOL-A-THON® Vol. 19.3
Fowler

Outside Inch Micrometers

with Decimal Equivalents on Frame



52-235-001-1



- Black decimal equivalents on satin chrome finished forged steel frame
- Graduations: 0.0001"
- Ratchet thimble and locking nut
- Includes standard for 1-2" sizes

Order No.	Range	Accuracy	Thimble	List Price	Sale Price
52-235-001-1	0 - 1"	± 0.0001"	Ratchet	\$67.56	\$51.00
52-235-002-2	1 - 2"	± 0.0001"	Ratchet	78.20	59.00
52-235-003-2	2 - 3"	± 0.0001"	Ratchet	97.76	73.00
Set					
52-235-100-0	0 - 3"			\$235.00	\$175.00

Swiss-Style Micrometers



52-229-201-0



- 0.0001" reading
- Carbide measuring faces
- Insulated frame
- Ratchet thimble and locking lever
- Microfine graduations
- Sizes over 1" include standard
- Includes case



52-229-213-0

Order No.	Range	Accuracy	List Price	Sale Price
52-229-201-0	0 - 1"	± 0.00016"	\$54.95	\$42.00
52-229-202-0	1 - 2"	± 0.00016"	64.35	49.00
52-229-203-0	2 - 3"	± 0.0002"	79.34	61.00
52-229-204-0	3 - 4"	± 0.0002"	91.08	70.00
Sets				
52-229-213-0	0 - 3"		\$198.09	\$154.00
52-229-214-0	0 - 4"		280.45	206.00
52-229-220-0	0 - 100mm		280.45	206.00

Fowler TOOL-A-THON® Vol. 19.3



Find us on social media!

f E in YouTube



Digit Counter Micrometers



52-224-001-0

- Digital counter reads to 0.001"
- Resolution: 0.0001" (using vernier)
- Microfine graduations on satin chrome
- Carbide tipped measuring faces
- Positive locking nut on spindle
- Sizes over 1" include standard
- Includes case



52-224-103-0

Order No.	Range	List Price	Sale Price
52-224-001-0	0 - 1"	\$116.01	\$85.00
52-224-002-0	1 - 2"	121.87	89.00
52-224-003-0	2 - 3"	138.81	102.00
52-224-004-0	3 - 4"	152.69	112.00
52-224-005-0	4 - 5"	161.61	118.00
52-224-006-0	5 - 6"	168.98	125.00
Sets			
52-224-103-0	0 - 3" set	\$366.22	\$265.00
52-224-104-0	0 - 4" set	519.31	380.00
52-224-220-0	0 - 75mm set	385.60	275.00

Micrometer Stands



52-247-005-0

- Unique locking nut adjusts micrometer stand to any position for perfect use and viewing
- Stand folds for storage

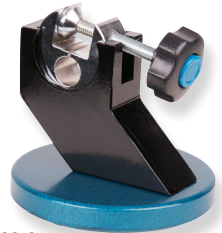

52-247-000-0

- Provides a measuring position and angle for outside micrometers and other instruments

XTRA MAG®

52-247-010-0

- Holds standard 0-12" micrometers firmly to metal surfaces
- Use at machine centers, work, assembly and inspection stations, steel tables and shelves
- V-bottom for mounting on cylindrical surfaces
- On/Off magnet switch
- Base is 2.30" L x 1.20" W x 3.50" H



Micrometer not included

Order No.	Description	List Price	Sale Price
52-247-000-0	Adjustable Micrometer Stand	\$60.38	\$46.00
52-247-005-0	Folding Micrometer Stand	40.41	32.00
52-247-010-0	Magnetic Micrometer Stand	54.12	42.00

Electronic IP65 Thread Micrometers



54-219-001-0



- Water Resistant to IP65 specifications
- True inch/metric conversion
- 60° measuring anvils
- ABS/INC measuring mode
- Positive spindle lock
- Painted enamel and heat insulated frame
- Resolution: 0.00005"/0.001mm
- Friction thimble
- Sizes over 1" include standard

Order No.	Range	Thread Range	Accuracy	List Price	Sale Price
54-219-001-0	0 - 1"	64 - 5 TPI/0.4 - 5mm	± 0.00008"/0.002mm	\$223.69	\$195.00
54-219-002-0	1 - 2"	44 - 3.5 TPI/0.6 - 7mm	± 0.00008"/0.002mm	239.29	207.00
54-219-003-0	2 - 3"	24 - 3.5 TPI/1 - 7mm	± 0.00008"/0.002mm	254.90	222.00
54-219-004-0	3 - 4"	24 - 3.5 TPI/1 - 7mm	± 0.00012"/0.003mm	270.50	234.00

Deep Throat Electronic Micrometers



54-517-001-0

54-517-002-0



- Range: 0 - 1"/0 - 25mm
- Resolution: 0.00005"/0.001mm
- ABS/INC modes
- Ratchet thimble

Order No.	Anvil	Accuracy	Throat Depth	List Price	Sale Price
54-517-001-0	Flat	± 0.00012"/0.003mm	6"	\$220.00	\$198.00
54-517-002-0	Ball	± 0.00016"/0.004mm	11.875"	245.00	220.00



Electronic IP54 Disc Micrometers



54-860-301-0

- Water Resistant to IP54 specifications
- True inch/metric conversion
- Accuracy: 0.00016"
- Resolution: 0.00005"/0.001mm
- Direct RS232 output
- Friction thimble
- Large easy-to-read LCD display
- Extra large .788" disc with .035" edge thickness
- Easily enters hard-to-reach areas



Order No.	Range	List Price	Sale Price
54-860-301-0	0 - 1" / 0 - 25mm	\$265.91	\$219.00
54-860-302-0	1 - 2" / 25 - 50mm with standard	286.16	239.00

Electronic IP54 Inside Micrometers

- Each gage includes appropriate setting ring
- Water Resistant to IP54 specifications
- Resolution: 0.00005"/0.001mm
- Large easy-to-read LCD display
- Friction thimble
- Includes case



54-860-275-0



Includes setting ring!

Order No.	Range	Accuracy	List Price	Sale Price
54-860-275-0	0.2 - 1.2"	0.00020"/0.005mm	\$245.34	\$199.00
54-860-276-0	1 - 2"	0.00024"/0.006mm	265.91	219.00

Inside Micrometers



52-275-001-1

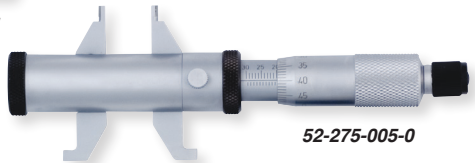

52-275-005-0

- Measuring faces are fully hardened, precision ground and microlap finished to assure exceptionally accurate measuring
- Spindle threads are hardened and ground
- Microfine graduations 0.001" on a satin chrome finish permit easy reading
- Ratchet stop thimble assures exact and repetitive readings
- Includes a setting ring

Order No.	Range	Graduation	Accuracy	List Price	Sale Price
52-275-001-1	0.2" - 1.2"	0.001"	0.0002"	\$116.01	\$87.00
52-275-005-0	0.2" - 2.2"	0.001"	0.0002"	196.12	155.00

Inside Micrometers

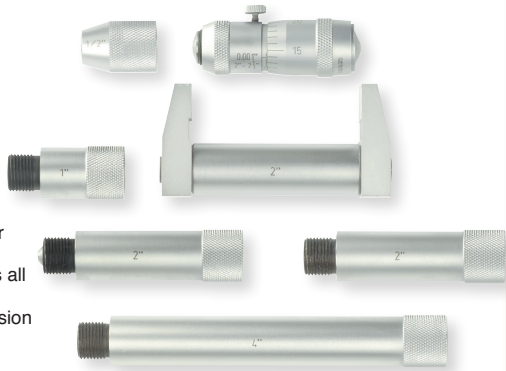

52-243-212-1

- Each set consists of an inside micrometer head and a series of fully hardened and lapped extension rods of different lengths all with carbide measuring faces
- Anvil and spindle are hardened and precision ground with microlap finish on ends
- Microfine graduations on satin chrome
- Positive locking nut on spindle
- It is recommended that the inside micrometer with a rod be calibrated by a micrometer or ring gage
- Coiled spring pressure contact type rods are each marked with appropriate length
- Quick, easy zero adjustment on the sleeve
- Accuracy: $0.00005'' \times (3 + L''/2)$
- Graduation: 0.001"
- Includes a wrench, case and reference standard

Order No.	Range	List Price	Sale Price
52-243-026-1	2 - 6"	\$142.63	\$114.00
52-243-212-1	2 - 12"	176.14	140.00
52-243-220-1	2 - 20"	228.32	180.00
52-243-240-1	2 - 40"	603.90	480.00
52-243-480-1	4 - 80"	1273.16	1075.00
52-243-512-1	4 - 120"	2780.61	1960.00

Micrometer Checking Set

Fowler's setting master is quick, easy and extremely accurate. It comes with a certificate of calibration and a fitted aluminum case. Save time and money by calibrating your own measuring tools quickly and easily.

Set Includes:

- Stand height: 12.5"
- 9 pc. Grade AS-0 gage block set (sizes: 0.625", 0.100", 0.125", 0.200", 0.250", 0.300", 0.500", 1.000" & 2.000")
- Certificate of calibration is traceable to NIST standards & provides the individual deviation of each block
- Optical flat (flatness: .000004" ; Parallelism: 0.00002")
- 4.0mm ball end T-handle hex wrench



**Buy the holder alone
for use with your own blocks!**

Order No.	Description	List Price	Sale Price
53-813-001-2	Complete Checking Set	\$347.99	\$299.00
53-813-002-0	Mic Checker <i>without</i> Blocks	174.40	139.00



Find us on social media!



TOOL-A-THON® Vol. 19.3

TOOL-A-THON®

Fowler®

Premium Depth Micrometers

- Clear microfine graduations on satin chrome finish
- Base constructed of hardened tool steel is precision ground and microlapped. All other surfaces are satin chrome finished.
- Quick and easy zero adjustment
- Rods hardened, ground and lapped on measuring surfaces and adjustable in either direction
- Interchangeable rods are fitted to the micrometer spindle against a positive stop and locked
- Ratchet thimble
- Threads hardened, ground and lapped for accuracy
- Price includes spanner wrench and fitted case



52-225-005-1

Order No.	Range	Graduation	Accuracy	Base Size	List Price	Sale Price
52-225-005-1	0 - 3"	0.001"	0.0002"	2.5"	\$164.50	\$139.00
52-225-006-1	0 - 4"	0.001"	0.0002"	2.5"	197.42	162.00
52-225-011-1	0 - 4"	0.001"	0.0002"	4"	197.42	162.00
52-225-020-1	0 - 6"	0.001"	0.0002"	2.5"	216.68	177.00
52-225-035-1	0 - 12"	0.001"	0.00028"	4"	350.98	285.00

Economy Depth Micrometers

- Satin chrome finish
- Base surface hardened and ground
- Ratchet thimble
- Locking clamp
- Rod diameter: 0.176"
- Includes case



52-225-110-0

Order No.	Range	Graduation	Accuracy	Base Size	List Price	Sale Price
52-225-110-0	0 - 4"	0.001"	0.0002"	2.5"	\$137.87	\$125.00
52-225-112-0	0 - 6"	0.001"	0.0002"	2.5"	162.82	145.00
52-225-114-0	0 - 4"	0.001"	0.0002"	4"	148.93	135.00

Digit Counter Depth Micrometers

- Easy-to-read digit counter
- Microfine 0.001" graduations
- 4" base constructed of tool steel, hardened and ground
- Satin chrome finish
- Ratchet thimble
- Locking clamp
- Rod diameter: .176"
- Includes wrench and fitted case

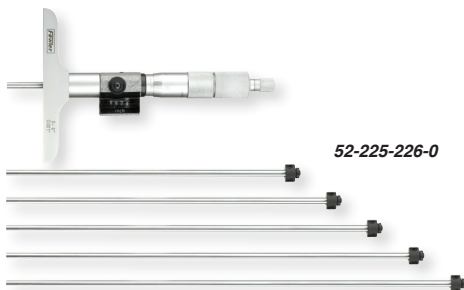

52-225-226-0

Order No.	Range	Graduation	Base	List Price	Sale Price
52-225-176-0	0 - 6"	0.001"	2.5"	\$197.64	\$155.00
52-225-226-0	0 - 6"	0.001"	4"	204.39	160.00

X-DEPTH 22[®] 0 - 22" Electronic Depth Gauge



- 0 - 1" travel electronic indicator
- Zero reset at any position
- On/off button
- Relative/absolute measuring
- Bottom surface of the base is hardened, ground & lapped
- Full 22" range
- Resolution .0005"/.01mm
- Hold feature
- 4" Base
- Includes 2 extra points for small hole applications; one 0.078" dia. x 1" long and one needle point x 1" long

Order No. **54-125-777-0**



Sale \$210.00

List \$271.07

X-DEPTH 22[®] 0 - 22" Dial Depth Gages

Twice the range of competitive products!

- 0 - 1" travel indicator
- 0.001" Graduations
- Rods connect together for full 22" capacity
- Satin chrome finish
- Base size: 4"
- Includes 2 extra points for small hole applications; one 0.078" dia. x 1" long and one needle point x 1" long



52-125-006-1

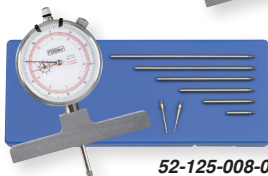

52-125-008-0



Order No.	Range	Graduation	Accuracy	List Price	Sale Price
52-125-006-1	0 - 22"	0.001"	± 0.001"	\$201.11	\$155.00
52-125-008-0	0 - 22"/558mm	0.001"/0.01mm	± 0.001"/0.03mm	219.30	180.00

X-PROOF[®] 0 - 22" Dial Depth Gauge

with IP54 protection!

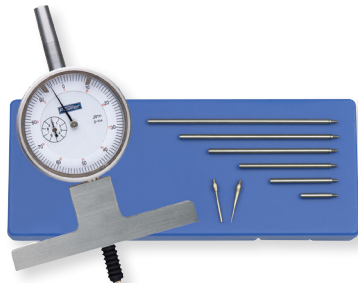

- 0-1" AGD Group 2 IP54 Indicator
- Sealed bezel, top cap and dial with bellows on stem
- Sealed back plate
- .001" graduations
- 4" base ground and lapped for flatness
- Rods connect for 22" capacity
- Includes 2 extra points (spline & needle)
- Tolerance markers

Order No. **52-125-007-0**



Sale \$165.00

List \$218.56





XTEST

Horizontal Indicators

- Solid copper body
- Super smooth jeweled movement
- Smoother bezel adjustment for easier zero setting
- 0.080" and 0.120" carbide ball contact points (0.040" steel ball)
- 0.060" range with auto reverse and rev. counter
- Easy to read tilted dial
- 5/32" pivotable stem



52-562-001-0

52-562-002-0

Includes NIST Certificate of Calibration

Order No.	Style	Graduations	Dial Diameter	Dial Reading	List Price	Sale Price
52-562-001-0	Horizontal	0.0005"	1-1/2"	0-15-0	\$132.36	\$105.00
52-562-002-0	Horizontal	0.0005"	1"	0-15-0	132.36	105.00
52-562-003-0	Horizontal	0.001"	1"	0-15-0	132.36	105.00
52-562-008-0	Horizontal	0.01mm	38mm	0-40-0	132.59	105.00

XTEST

Vertical Indicators

TWICE the range of most indicators!

- Graduations: 0.0005"
- Dial diameter: 1" and dial reading: 0 - 15- 0
- Solid copper body and super smooth jeweled movement
- Smoother bezel adjustment for easier zero setting
- 0.080" and 0.120" carbide ball contact points (0.040" steel ball)
- 0.060" range with auto reverse and rev. counter
- 5/32" pivotable stem



52-562-005-0

Includes NIST Certificate of Calibration



Order No.	Style	Graduations	Dial Diameter	Dial Reading	List Price	Sale Price
52-562-004-0	Vertical	0.0005"	1-1/2"	0-15-0	\$144.94	\$105.00
52-562-005-0	Vertical	0.0005"	1"	0-15-0	144.94	105.00
52-562-006-0	Vertical	0.001"	1"	0-15-0	144.94	105.00

XTEST

X-Test Indicator & Accessory Combo Kits

Each Combo Kit Includes:

- X-Test Dial Test Indicator
- Axial support
- Height gage bar with clamp
- Adaptor sleeve: 5/32" to 3/8"
- Contact point case
- Contact point wrench
- Complete in shop hardened case



52-562-110-0

Order No.	Description	Graduations	List Price	Sale Price
52-562-100-0	52-562-001-0 w/accessories	0.0005"	\$194.34	\$165.00
52-562-110-0	52-562-002-0 w/accessories	0.0005"	172.65	149.00
52-562-120-0	52-562-003-0 w/accessories	0.001"	194.34	165.00

Test Indicators

All Fowler Test Indicators include bi-directional constant clockwise rotation, automatic reversal, three dovetail mountings, jeweled movement, two dovetail clamps and a molded case.



Order No.	Face Color	Total Range	Dial Reading	Graduation	Dial Diameter	Point Length	List Price	Sale Price
52-562-774-0	white	0.030"	0-15-0	0.001"	1"	1/2"	\$124.42	\$85.00
52-562-775-0	white	0.030"	0-15-0	0.0005"	1"	1/2"	132.21	85.00
52-562-776-0	white	0.030"	0-15-0	0.0005"	1-1/2"	1/2"	138.28	85.00
52-562-780-0	black	0.030"	0-15-0	0.0005"	1-1/2"	1/2"	138.28	85.00



Order No.	Face Color	Total Range	Dial Reading	Graduation	Dial Diameter	Point Length	List Price	Sale Price
52-563-770-0	white	0.008"	0-4-0	0.0001"	1"	1/2"	\$132.21	\$90.00
52-563-771-0	black	0.008"	0-4-0	0.0001"	1"	1/2"	132.21	90.00
52-563-777-0	white	0.008"	0-4-0	0.0001"	1-1/2"	1/2"	132.21	90.00

Test Indicator Set with Certificate of Calibration

Test Indicator:

- Auto-reverse
- Jeweled movement
- Range: 0.030"
- Graduation: 0.0005"
- Dial Reading: 0-15-0
- Dial Diameter: 1.125"
- Point length: 0.400"
- Carbide contact points

FREE



Set Also Includes:

- 0.080" & 0.040" contact points
- Universal clamp
- Height gage attachment
- 3/8" & 1/4" dovetail clamps
- Manufacturer's test certificate
- Meets ANSI Specs for accuracy
- All in a fitted molded case

Order No. 52-562-999-0

Sale \$125.00

List \$145.12

Prices & Specifications are subject to change without notice.

37

Fowler TOOL-A-THON® Vol. 19.3



Find us on social media!

Find us on social media!

INDI-X^{blue} Electronic Indicators

- 2-1/4" dial face
- Lugback and 3/8" stem mountings
- Resolution 0.0005"/0.01mm
- Tolerance function
- Absolute/incremental reading
- Floating zero



INCH • METRIC • FRACTIONTM

"Easy to use, easy to read, top notch accuracy"
Mr. R.



54-520-250-0

54-520-260-0

Carbide-tipped point!

Order No.	Description	List Price	Sale Price
54-520-255-0	0.50"/12.5mm Indi-X Blue	\$103.08	\$75.00
54-520-250-0	1"/25mm Indi-X Blue	110.99	80.00
54-520-260-0	1"/25mm/64ths Indi-X Blue Inch-Metric-Fraction	112.61	85.00

Depth Base Attachments

- Turn your dial or electronic indicator into a depth gage (may reduce range)
- 4" length
- Fits indicators with 3/8" and 8mm mounting stems
- Ground and lapped base
- Each supplied with 4 extension points, for added application range (4 - 48 thread)
- 52-125-005-0 has 0.430" radius



52-125-004-0

Order No.	Description	List Price	Sale Price
52-125-004-0	Flat depth base attachment	\$40.88	\$32.00
52-125-005-0	Radius style depth base attachment	40.88	32.00

Indicator Chucks



52-526-020-0

- Low carbon steel, black oxide finished
- 0.0140" - 0.040" chucking capacity
- Can be used with small pin gages for special or restricted applications
- Available in both 4 - 48 and M2.5 threads



Indicator shown not included

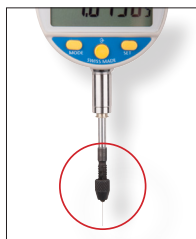

Order No.	Description	List Price	Sale Price
52-526-020-0	Indicator Chuck with 4 - 48 thread	\$23.93	\$20.00
52-526-021-0	Indicator Chuck with M2.5 thread	23.93	20.00

INDI-X^{blue}

Small Face Electronic Indicator

- Range: 0 - 0.50"/0 - 12.5mm
- Accuracy: $\pm 0.0008''/0.02\text{mm}$
- Resolution: 0.0005"/0.01mm
- 1.76" dial face
- Carbide tip
- Contains flat and center lug backs
- Includes NIST certification and fitted case



Order No. 54-520-275-0

Sale \$85.00

List \$114.44

INDI-X^{blue}

IP65 HIGH Resolution Electronic Indicator

- Range: 1"/25mm
- Accuracy: $\pm 0.0002''/0.005\text{mm}$
- Resolution: 0.00005"/0.001mm
- IP65 protected
- Carbide tip
- Tolerance function
- Contains flat and center lug backs
- Includes NIST certification and fitted case



Order No. 54-520-270-0

Sale \$115.00

List \$151.90

INDI-X^{blue}

IP65 Electronic Indicator

- Range: 1"/25mm
- Accuracy: $\pm 0.0012''/0.03\text{mm}$
- IP65 protected
- Carbide tip
- Tolerance function
- Contains flat and center backs
- Includes NIST certification and fitted case



Order No. 54-520-265-0

Sale \$100.00

List \$126.93

Fowler TOOL-A-THON[®] Vol. 19.3



Find us on social media!

Find us on social media!







Premium Dial Indicators

- Tolerance markers
- Solid steel housing
- Carbide contact point

**3 year
Warranty**



52-520-135-0

Fowler
Calibration Certificate

Part Number: 52-520-135-1 Tool Description: Dial Indicator
 Serial Number: 63055
 Part Standard: ASME B89
 Temperature: 20°C
 Visual Inspection: Pass

Measur: _____ Pass/Fail

1	P
2	P
3	P
4	P
5	P
6	P
7	P
8	P
9	P
10	P

Reference used: Gage _____ Number: 122230
 Held in Service: _____
 Calibration Date: 04-23-2015
 Inspector: _____
 Purchased/Activation Date: _____

Fowler Precision: 68 Bates Street, P.O. Box 100, Needham Heights, MA 02461
 Tel: 781-455-1200 Fax: 781-455-1201
 E-mail: sales@fowlerusa.com
 Website: www.fowlerusa.com



52-520-110-2

"Great price for a great indicator" V.C.



**Includes NIST
Certificate of Calibration**

52-520-110-1

Order No.	Range	Graduation	Reading	Balanced Reading	Dial Color	List Price	Sale Price
52-520-110-1	1"	0.001"	0 - 100	—	Black Face	\$92.91	\$65.00
52-520-110-2	1"	0.001"	0 - 100	—	White Face	92.91	65.00
52-520-129-0	1"	0.0005"	0 - 50	0 - 25 - 0	White Face	112.36	75.00
52-520-135-0	0.05"	0.0001"	0 - 10	0 - 5 - 0	White Face	161.01	110.00
52-520-125-0	0.250"	0.0005"	0 - 50	0 - 25 - 0	White Face	122.64	82.00

X-PROOF® Dial Indicator

- Range: 0.40"
- Graduation: 0.001"
- Continuous reading: 0-100
- Contact point: M2.5
- Tolerance markers
- AGD Group 2, 2-1/4" dia.
- Lugback and carbide point
- Meets ANSI specs for accuracy
- Rubber bellows on stem
- O-ring seal on safety cap
- O-ring protection for bezel and rotating dial
- Sealed back plate
- Robust, shockproof design



Protected to
IP54
COOLANT & FLUID
RESISTANT

Order No. **52-520-444-1**

Sale \$115.00 List \$153.13

Inch/Metric Reading Dial Indicator

TWO Gages in ONE!

- Range: 1"/25mm
- Graduations: 0.001"/0.01mm
- AGD group 2
- Carbide ball contact point
- Dial face reads in inch (black) or metric (red) simultaneously
- Reading: 0 - 100 (inch)/0 - 200 (metric)
- Separated dial for inch and metric
- 3/8" mounting stem

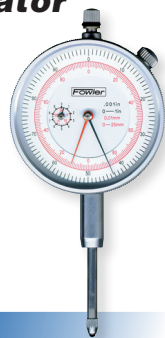

Order No. **52-530-110-0**

Sale \$75.00 List \$95.28

TOOL-A-THON® Vol. 19.3

Fowler

Magnetic Bases

- 9.5" Height and 85 lb. pull
- Base dimensions are 2" x 2-11/32" x 1-13/16" (50mm x 58.7mm x 46mm)
- Accepts all AGD dial indicators
- V-bottom base allows mounting on cylindrical surfaces
- Mounts test indicators with 1/4" post mount



Order No.	Description	List Price	Sale Price
52-585-005-0	Magnetic base	\$52.86	\$38.00
52-585-010-0	Magnetic base w/fine adjustment	62.16	44.00

Flex Arm Magnetic Base

- All purpose magnetic base with 180 lbs. of pulling power
- Base can be mounted vertically as well as horizontally
- V-bottom base allows mounting on cylindrical surfaces
- Adjusts to virtually any position

Order No. **52-585-015-0**

Sale \$61.00

List \$81.99



AnyForm Magnetic Base

- Versatile—70 steel segments work like a contour gage to fit mag base securely to any shape or form
- Unlock the cam mechanism and magnetic segments will conform to any odd shape
- Rigid one-piece construction with permanent powerful magnet holds securely
- There's no longer any need to make extra fixtures to set indicators
- Unlimited versatility—used with coolant systems, lamps, etc.
- Side arm clamp holds all AGD dial indicators and all test indicators with a 1/4" dia. stem

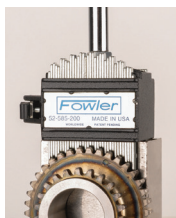

Order No. **52-585-200-0**

Sale \$76.00

List \$96.62

Fowler

TOOL-A-THON® Vol. 19.3



Find us on social media!



TOOL-A-THON® Vol. 19.3
Fowler®

XTENDER

Electronic Bore Gage Set with Carbide Anvils

Industry's two most popular bore gage ranges combined in one easy-to-use electronic set!
 Preset size of master for absolute reading and use minimum hold feature to lock on the bore size as the gage is rocked in the part to be measured.



Bore Gage features:

- Range: 1.4 - 6" / 35 - 150mm
- Resolution: 0.00005"/0.001mm
- Carbide anvils
- Self-centering

Indicator features:

- Bar graph and numeric digital display
- Preset with recall
- ABS/INC measurement
- Min/Max/TIR

*"Excellent quality,
well built."*

Lee C.



Order No. 54-646-401-0

Sale \$255.00 List \$339.94

Dial Bore Gage Sets with Carbide Anvils

Industry's two most popular bore gage ranges combined in one set!

- Carbide Anvils
- Easy-to-read
- Economical
- Graduation: 0.0005", 0.0001" or 0.01mm
- Insulated grip
- 9.5" Depth
- Chrome plated handle
- Includes fitted case

XTENDER



52-646-400-0



52-646-100-0



Order No.	Range	Graduation	List Price	Sale Price
52-646-100-0	0.7 - 1.5"	0.0005"	\$156.63	\$115.00
52-646-400-0	1.4 - 6"	0.0005"	196.75	140.00
52-646-500-0	1.4 - 6"	0.0001"	246.55	180.00
52-646-220-0	35 - 60mm	0.01mm	217.41	145.00

XTRA-RANGE® 4" to 12" Dial Bore Gage

- Carbide Anvils
- 4" to 12" range
- 10" measuring depth
- Easy-to-read
- Economical
- Graduation: 0.0005"
- Insulated grip
- Chrome plated handle
- Includes 2 contact extensions



Order No. 52-646-600-0

Sale \$175.00

List \$233.25

Bore Gage Setting Master Kits - Inch & Metric

Fowler's Bore Gage Setting Master Kit is used for accurately setting any bore gage up to 6"/150mm in diameter to an accuracy of 0.0001"/0.003mm

Each Set includes: Setting Device (53-646-000-1 - Inch Model)

- Base anvil: 3.950" x 1.050"
- Adjustable anvil 2.375" x .375" (two each)
- Internal capacity: 6"/150mm
- Depth capacity: 1"/25mm
- Centralizer capacity width: 2.750"
- Quick-release holder for fast adjustment
- **Can also be used for external setting, depending on application (external mics, snap gages, caliper gages)**

Economy Gage Block Sets

Inch model:

- 36 piece
- Tolerances to .00005"
- Certificate of Calibration to NIST

Metric model:

- 33 piece
- AS-2 grade
- Certificate of Calibration to NIST

Includes:
Bore gage setting master
and gage block set.
All in a custom-fitted
case!



53-646-000-1

Bore gage shown not included



Instructional video available at youtube.com/FowlerVid

Order No.	Description	List Price	Sale Price
53-646-000-1	Inch Bore Gage Setting Master Kit	\$315.68	\$230.00
53-646-010-0	Metric Bore Gage Setting Master Kit	328.95	240.00
53-646-005-0	Bore Gage Setting Master Kit - without Gage Blocks	182.07	160.00

Fowler®

TOOL-A-THON® Vol. 19.3



Find us on social media!

Find us on social media!

YouTube
LinkedIn
Twitter
Facebook



TOOL-A-THON® Vol. 19.3

Fowler®

Vernier Height Gages



- Adjustable main scale. Quickly "reset" zero or for easy reading without special calculations
- Swing-away magnifier plus extra long vernier scales with wide separations in inch and metric
- Fine adjustment mechanism
- Carbide tipped scriber for direct reading over the full range
- Satin-chrome finish for glare free reading. Raised lands prevent friction wear.
- Beam & slide of hardened stainless steel. Base and measuring surfaces all hardened tool steel, carefully ground and microlapped.
- Graduations: 0.001" and 0.02mm

52-174-012-0

Order No.	Range	List Price	Sale Price
52-174-012-0	12"/300mm	\$315.23	\$235.00
52-174-024-0	24"/600mm	721.30	\$515.00
52-174-040-0	40"/1000mm	1639.23	\$999.00

Twin Beam Dial Height Gages

- Separate digit counters register both upward & downward travel
- Zero setting can be obtained throughout the gage's range
- Coarse readings in 0.100" graduations; fine readings taken on indicator are 0.001"
- Dual chrome plated beams
- Carbide-tipped scriber.
- Base is hardened, ground & lapped for maximum flatness
- Accuracy: 12" - ± 0.0015"
24" - ± 0.002"

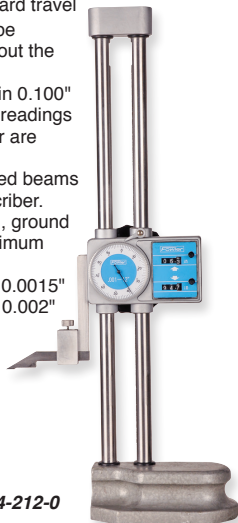

52-174-212-0

Order No.	Range	List Price	Sale Price
52-174-212-0	12"	\$296.51	\$225.00
52-174-224-0	24"	494.19	\$315.00

Twin Beam Electronic Height Gage with Offset Scriber

- Range: 12"/300mm
- Accuracy: ± 0.0016"/0.04mm
- Carriage design with offset scriber holder
- Base is ground and lapped for flatness
- Handwheel provides course and fine movement
- Updated electronic and mechanical design offers better accuracy and movement of carriage
- Carbide tipped scriber
- Functions include preset, in/mm conversion and ABS/INC for direct or comparative measuring



Order No. 54-174-212-3

Sale \$425.00 List \$494.19

Electronic Height Gages

An economical height gage that offers high quality, accuracy and durability.

- Large base for easy movement
- Resolution: 0.0005"/.01mm
- Accuracy: ± 0.0025"
- Repeatability: 0.0005"/0.01mm (±2s)
- Large easy to read LCD
- Overall height: 28"
- Presetable display

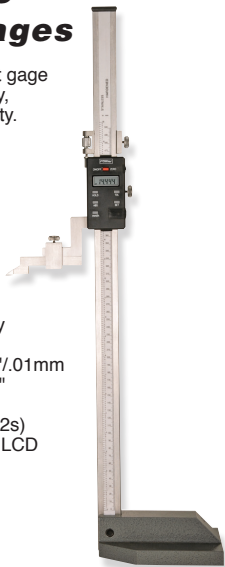

Order No.	Range	List Price	Sale Price
54-106-020-0	20"/50mm	\$426.18	\$285.00
54-106-040-0	40"/1000mm	1960.70	\$1200.00

Z-HEIGHT Electronic Height Gages

New Design!

- **NEW** base design with painted enamel finish has a more comfortable grip and is finely ground and lapped for smooth movement on surface plates
- **NEW** fine adjust feature allows precise adjustment to required settings
- **NEW** preset feature allows setting pre-determined or reference measurements
- **NEW** 2 indicator holding bars included (3/8" and 8mm)
- Direct inch/metric conversion
- Resolution 0.0005"/0.01mm
- Floating zero
- Large, high contrast LCD display
- Coarse adjustment hand wheel
- Carriage locking lever
- Carbide tipped scriber

FREE



PLUS+
SERIES

Order No.	Range	Accuracy	List Price	Sale Price
54-175-012-0	12"/300mm	± 0.0016"/0.04mm	\$524.56	\$400.00
54-175-018-0	18"/500mm	± 0.002"/0.05mm	611.57	465.00
54-175-024-0	24"/600mm	± 0.002"/0.05mm	688.39	525.00



Z-HEIGHT ABS Electronic Height Gages

- **NEW** True ABS measuring system
- Supplied with a NIST certified test block (1" x 2" x 3")
- Includes indicator holding bar (3/8" and 8mm)
- Supplied with mini USB data cable
- Heavy duty single column design
- Carbide scriber
- Ground and lapped base for smooth movement
- Steel rack with large hand wheel for coarse and fine adjustment
- Positive locking level for scriber
- Can be used with wireless transmitter (54-115-100-0)

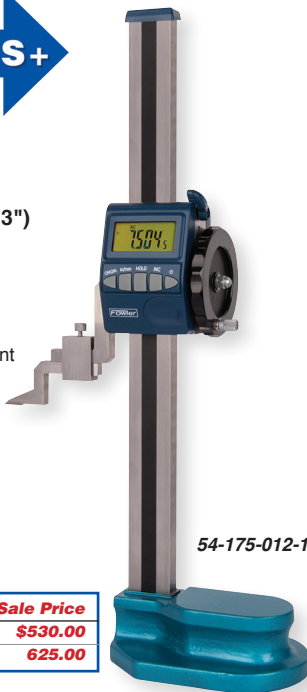

Order No.	Range	Accuracy	List Price	Sale Price
54-175-012-1	12"/300mm	± 0.0016"/0.04mm	\$601.78	\$530.00
54-175-018-1	18"/500mm	± 0.002"/0.05mm	708.90	625.00

Fowler® TOOL-A-THON® Vol. 19.3



Find us on social media!



Find us on social media!

YouTube
LinkedIn
Twitter
Facebook



Digi Level PLUS+

- Super large 18mm backlit display
- Includes a 6" straight edge with beveled edge and 1/64th graduations
- Smart wireless model available
- V's on top and bottom for measuring on cylindrical surfaces
- Embedded magnets on bottom base for vertical and horizontal hold
- Resolution: 0.050°
- Accuracy: $\pm 0.2^\circ$
- IP65 protection
- Rechargeable battery
- USB charging cable supplied
- Auto inverting display



54-422-550-0



Order No.	Description	List Price	Sale Price
54-422-550-0	Digi-Level PLUS	\$125.51	\$110.00
54-422-550-BT	Digi-Level PLUS with Bluetooth	141.88	125.00

mini-MAG Protractor™

The mini-MAG Protractor provides instant 360° digital inclination display of any angle with the additional unique feature of embedded magnets on both sides and the bottom which make it ideal for a variety of measurements.

- Embedded magnets with 3.5lb. pull
- Uses standard 9V battery (250 hrs.)
- Measuring range: 360° (4 x 90°)
- Display automatically inverts
- Resolution: 0.05°
- Accuracy: $\pm 0.2^\circ$
- Repeatability: 0.05°
- Dimensions: 2.375" x 1.375" x 2.375"
- Hold feature



Display inverts for easy reading!



- 54-422-460-0
- On/off, tilt %, light, zero functions
 - Display is backlit for low light areas



54-422-450-1

Order No.	Description	List Price	Sale Price
54-422-450-1	mini-MAG protractor	\$105.72	\$62.00
54-422-460-0	NEW mini-MAG II protractor	111.18	67.00

mini-MAG PLUS

The Mini-Mag PLUS Protractor features a USB rechargeable battery, a backlit display, Tilt% function and IP54 protection against water, oil, and fluids.

- 6 month battery life
- Auto off after 5 minutes
- Embedded magnets
- Measuring range: 360° (4 x 90°)
- Display automatically inverts
- Resolution: 0.05°
- Accuracy: $\pm 0.2^\circ$
- Repeatability: 0.05°
- Hold feature
- Zero function
- Smaller size: 2.12" x 2.12" x .9"



Order No. 54-422-500-0

Sale \$77.00 List \$116.89

TOOL-A-THON® Vol. 19.3

Fowler®

Combination Square

- Blades are chrome plated, fully hardened and tempered
- Includes square, protractor and center head with 12" blade
- Square head has level and scriber point
- Double indexed protractor is graduated 180° in both directions
- Graduated in 8ths, 16ths, 32nds and 64ths



Order No. **52-370-012-0**

Sale \$150.⁰⁰

List \$212.85

Steel Squares & Sets



52-432-246-0

- Made of the finest carbon tool steel, these economy squares have true right angles both inside and outside
- Beams and blades ground and lapped for straightness and parallelism
- Hardened blade
- Beam grooved at inner corner for clearance of burrs and dirt
- Squareness of blade edge to the working face: 2" & 3" = ± 0.0006", 4" & 6" = ± 0.0008", 9" & 12" = ± 0.0012"

Sets come complete in a "Shop Hardened" molded case!

Blade Size	Beam Size
2"	1.5"
3"	2.5"
4"	3"
6"	4"
9"	6"
12"	8"

Order No.	Size/Description	List Price	Sale Price
52-432-444-0	3 Piece Square Set: 2", 4" & 6" with shop hardened case	\$75.01	\$65.00
52-432-246-0	4 Piece Square Set: 2", 3", 4" & 6" with shop hardened case	89.36	78.00

Cylindrical Squares

- Used for checking squares, height gages and other instruments
- Hardened and the ends are lapped to 90° angular accuracy
- 6" cylindrical squares: ± 0.0001"
- 12" cylindrical square: ± 0.00015"
- Includes handles and wood case

52-750-012-0

52-750-006-0



Order No.	Description	List Price	Sale Price
52-750-006-0	6" cylindrical square	\$200.91	\$170.00
52-750-012-0	12" cylindrical square	286.94	245.00

Prices & Specifications are subject to change without notice.

Fowler®

TOOL-A-THON® Vol. 19.3



Find us on social media!

Find us on social media!



1-2-3, 2-3-4 & 2-4-6 Blocks

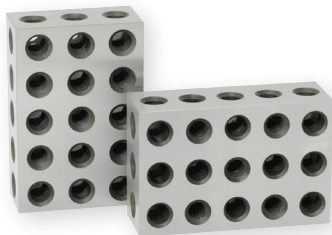

52-439-234-0

- 23 holes for easy clamping
- 52-439-001-0 features one hole only
- Sold in pairs
- Hardened 56 - 60 HRC
- Useful in layout & grinding work

Order No.	Description	Accuracy	List Price	Sale Price
52-439-001-0	1-2-3 Blocks	± 0.0002"/1"	\$145.59	\$99.00
52-439-234-0	2-3-4 Blocks	± 0.0001"/1"	96.90	85.00
52-439-246-0	2-4-6 Blocks	± 0.0003"/1"	224.62	145.00

X-BLOX® V-Block Set



2 each @:

- Dimensions: 1-1/2" L x 1-1/4" W x 1-1/4" H
- Work capacity: Approximately 1"

2 each @:

- Dimensions: 2" L x 1-1/2" W x 1-1/2" H
- Work capacity: 1-1/2"

All feature:

- Surfaces are square and parallel within 0.0005"
- V-grooves are square and parallel with all surfaces within 0.0005"
- Corresponding dimensions for each pair are alike within 0.0005"

"You will not go wrong buying this product"

J.B

Order No. 52-475-500-0

Sale \$120.00

List \$136.39

Parallel Set

- 1/2", 5/8", 3/4", 7/8", 1", 1-1/8", 1-1/4", 1-3/8", 1-1/2" & 1-5/8" heights
- 6" in length
- Height specifications relate to consistency within each pair. Absolute heights are nominal
- Hardness: 50 HRC, 6" length and 1/32" thickness
- Parallelism: ± 0.0002"
- Paired Height: ± 0.001"



Order No. 52-437-000-0

Sale \$180.00

List \$243.03

Transfer Punch Set



- Punches are made of hardened and tempered tool steel, black oxide finished
- All sizes are marked and diameters are slightly undersized for easy handling
- Set supplied with index stand

Order No. 52-482-028-0

Sale \$40.00

List \$54.55

TOOL-A-THON® Vol. 19.3
Fowler®

Carbide Super Scriber



- Lightweight • Retractable carbide tip • Knurled grip • Machined aluminum body • Pocket clip

Order No.	Description	Overall Length	List Price	Sale Price
52-500-050-0	Carbide Super Scriber	6.5"	\$35.66	\$28.50
52-500-055-0	Carbide Refill		10.92	9.50

Metal Etching Pen

A "must" for any tool room and machine shop for general marking purposes, Fowler's metal etching pen is used on copper, copper alloy, stainless steel, hardened steel tools and castings, etc. Use it to initial personal tools. Its low-cost, disposable design offers limitless applications. Overall length is 6-1/4"



Order No. **52-730-005-0**

Sale \$15.00

List \$21.85

2 in 1 Scriber & Center Punch

- Contains a carbide tipped scriber and a steal center punch all in 1 tool
- Carbide tip is reversible for double the life
- Knurled finger grip
- 1/8" center punch tip
- Supplied with convenient pocket clip



← Remove Scriber Tip To Access Center Punch Below!



Order No. **52-500-060-0**

Sale \$8.00

List \$10.07

Hardness Tester File Set Six color-coded system

Fowler's Hardness Tester File Set is an inexpensive, easy-to-use method for determining material hardness by sliding the file across the object's surface. Six color coded files indicate hardness from 40 to 65 HRC. Conveniently packaged in a leather-like case with a velcro lined flap, the files are approximately .157" in diameter and 7" in length (4.30 x 175mm).



Color	Indication	File Hardness	
Red	40 HRC	40-42 HRC	392-412 HV
Yellow	45 HRC	45-47 HRC	446-471 HV
Light Green	50 HRC	50-52 HRC	513-544 HV
Green	55 HRC	55-57 HRC	595-633 HV
Blue	60 HRC	60-62 HRC	697-746 HV
Black	65 HRC	64-66 HRC	800-865 HV

Order No. **52-760-000-0**

Sale \$125.00

List \$152.05

Fowler

TOOL-A-THON® Vol. 19.3



Find us on social media!

Find us on social media!
 YouTube
 LinkedIn
 Facebook
 QR Code

SHOP-BLOX® Rectangular Gage Block Set



- 81 pieces
- Manufactured to meet N.I.S.T. Federal Specification ASME B89. 1.9 - 2002 tolerances on length for inch gage blocks
- Certificate of Calibration traceable to N.I.S.T.
- Tolerances to $\pm 0.00005''$
- In high-quality fitted wood case



Order No. 53-672-081-0

Sale \$415.00

List \$550.18

X-TENDED RANGE® Pin Gage Set Minus and Plus Tolerances



Ideal for checking hole size, location, gage slots, distance between holes, go/no-go gaging and setting other gages and micrometers.

**Two ranges
 in one set!**

0.011" - 0.060" & 0.061" - 0.250"



- Class ZZ
- Black oxide finish offers extra protection against corrosion and rust, promotes longer life, and highlights wear trends that enables calibration to be performed more effectively
- 240 pcs
- Range: 0.011" - 0.250" in .001" increments.
- Set includes 2 handles and our X-Glide all purpose teflon lubricant
- Certificate of accuracy traceable to N.I.S.T. and registered ISO 9001

53-880-823-0

Order No.	Description	Accuracy	List Price	Sale Price
53-880-823-0	Plus Pin Gage Set	+0.0002", -0.0000"	\$256.33	\$195.00
53-880-833-0	Minus Pin Gage Set	+0.0000", -0.0002"	256.33	195.00

Pin Gage Handles

- 8 sizes cover a full range of pin gages (0.011" - 1.0")
- Color coded handle for GO, NO/GO applications
- Both handle and collets are made of aluminum for pin protection
- Collets are spring loaded and self-centering



53-885-001-0



53-885-000-0

Order No.	Description	List Price	Sale Price
53-885-000-0	0.011" - 0.060"	\$20.25	\$16.00
53-885-001-0	0.061" - 0.250"	23.83	19.00
53-885-002-0	0.251" - 0.500"	28.00	22.00
53-885-003-0	0.501" - 0.625"	30.98	24.00
53-885-004-0	0.626" - 0.750"	37.88	29.00
53-885-005-0	0.751" - 0.832"	41.34	33.00
53-885-006-0	0.833" - 0.916"	45.91	37.00
53-885-007-0	0.917" - 1.0"	51.69	42.00
53-885-008-0	All Sizes 0.011" - 1.0"	263.98	200.00

X-PRO™

- Small, compact size
- 2 selectable parameters: Ra and Rz
- Large LCD display
- Meets ISO and DIN standards
- N.I.S.T. traceable specimen included
- Uses 9 volt battery (approx. 3000 measurements)
- Includes fitted case



FREE



Shop Apron
with purchase

54-410-500-0



(X-Pro shown with optional stand with swivel)

The X-Pro Portable Roughness Tester II can be used for many applications by selecting from a variety of accessories, including:

- Stand with swivel
- A variety of probes

RS232 is available on certain models (contact the Fowler technical department for more information)

X-Pro Portable Roughness Tester II

Order No.	Description	List Price	Sale Price
54-410-500-0	Portable Surface Roughness Tester 0.0004" probe (NIST specifications)	\$1833.42	\$1550.00
54-410-600-0	Portable Surface Roughness Tester 0.0002" probe (DIN specifications)	1833.42	1550.00

X-Pro Portable Roughness Tester II Stand with Swivel

Order No.	Description	List Price	Sale Price
54-400-896-0	Stand with Swivel Attachment	\$441.53	\$399.00

X-Pro Portable Roughness Tester II Probes and Accessories

Order No.	Description	Resolution	List Price	Sale Price
54-400-319-0	General Purpose Probe	0.0004"	\$610.70	\$550.00
54-400-326-0	General Purpose Probe	0.0002"	610.70	550.00
54-420-321-0	Small Bore Probe	0.0004"	797.21	695.00
54-420-327-0	Small Bore Probe	0.0002"	797.21	695.00
54-420-301-0	Traverse Chisel Probe	0.0004"	797.21	695.00
54-420-302-0	Parallel Chisel Probe	0.0004"	797.21	695.00
54-420-328-0	Groove Bottom Probe	0.0004"	797.21	695.00
54-420-120-0	AC Adapter Kit		67.44	55.00





HIGH PRECISION
www.fowlerprecision.com

Distribution Center & Showroom
Cresskill NJ and Paradise Pa
866-945-5742/ sales@willrich.com