

Mitutoyo

Mitutoyo Quality

Varifocal Lens TAGLENS

Optical Measuring



A close-up, angled view of a black Mitutoyo TAG LENS camera lens. The lens is the central focus, with its front element visible. The body of the lens is black with the Mitutoyo logo and 'TAG LENS' printed in white and orange. The background is dark and out of focus, showing some mechanical parts of a machine.

Mitutoyo

Mitutoyo
TAG
LENS

TAGLENS

Ultra-deep-focus eliminates the most important conventional lens limitation.

In optical inspection of three-dimensional targets the complicating factors of variable distance and inclination, movement and multiple reflections inevitably result in some surfaces being out of focus in every image captured, which has always been the major issue with conventional lenses. But now the revolutionary TAGLENS enables a completely in-focus image of the target to be captured instantaneously. This ground-breaking ultra-deep-focus capability has the potential to improve efficiency and productivity and to dramatically reduce the cost of using optical inspection methods.

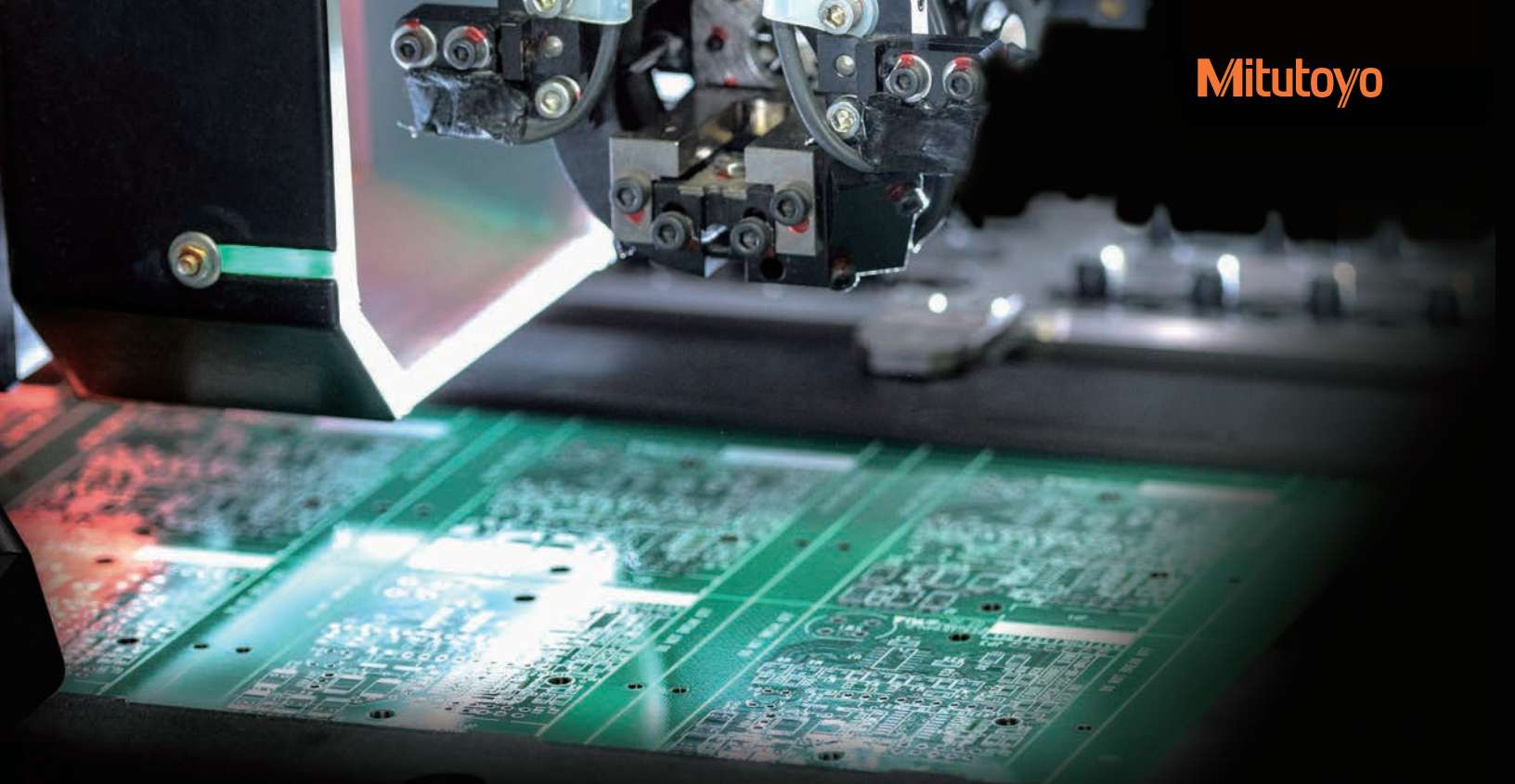

Flaw inspection

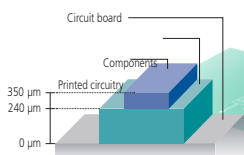

Enables effective inspection by focusing on each target area without focal length adjustment

Incorporating TAGLENS into a microscope allows it to be used for PCB flaw inspection, for example. There are three aspects to PCB inspection: the circuit board, the printed circuitry and the electronic components, which normally require multiple image captures while adjusting the lens' focal length. In comparison, using TAGLENS for inspection allows multiple subjects with different heights to be focused correctly, thus requiring only a single image capture, and reducing inspection time significantly.

Appearance inspection of containers

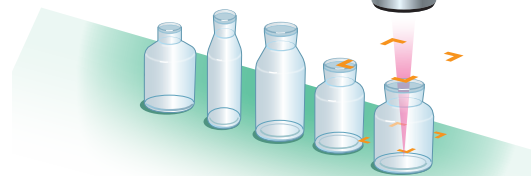

Simultaneously focusing on surfaces at different heights

Conventionally, focusing on points with different heights required altering the height of the camera. Now TAGLENS instantly and precisely focuses on each point without adjustments, bringing efficiency to inspection work.

Observing fluid composition

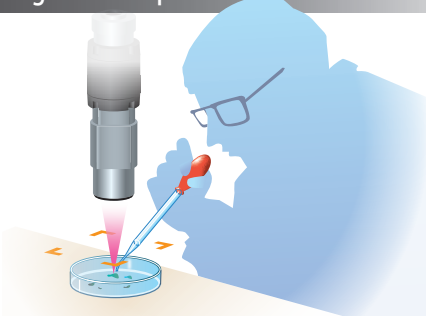

Unstable and moving targets can be inspected

By installing TAGLENS on a microscope, suspended solids at different distances from the objective lens and moving microorganisms can be comprehensively and precisely observed.

Bar code reading inspection

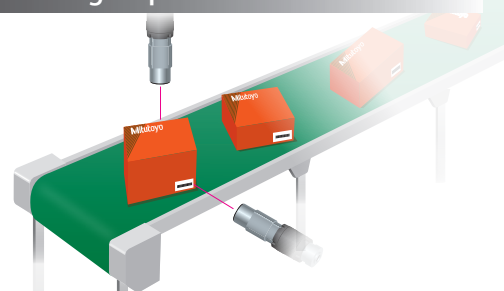

Enables bar code reading regardless of position or direction

Thanks to the wide focus range, the camera does not need to move to focus on the bar code of the targets on a conveyor belt, even if the height or direction of each target face is different.

ABILITY

TAGLENS, the breakthrough ultra-fast varifocal lens, will always be in focus, even with height differences, ensuring the highest observation efficiency ever.



Improve inspection efficiency using TAGLENS with its ultra-wide focus range

High speed, real-time all-focused-image is obtained

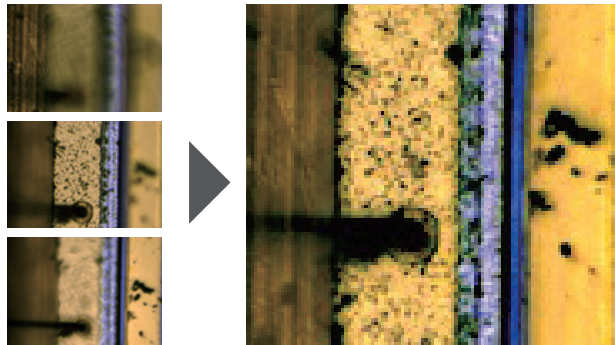

A real-time all-focused-image is obtained by scanning the focal length range at high speed. TAGLENS requires absolutely no mechanical power when scanning, and is characterized by its ability to provide images across all focal lengths without stress, and at the desired magnification and resolving power.

TAGLENS does not require an auto focus mechanism

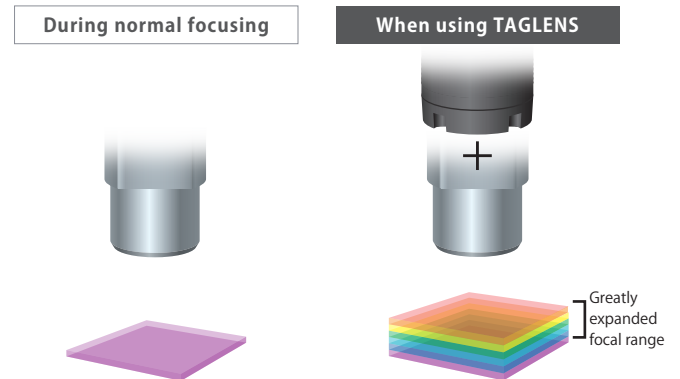

TAGLENS does not require a mechanical auto focus. TAGLENS reduces the time consumed for auto-focusing, contributing to the improvement of the data processing speed of the inspection device.

The focus range is variable without changing the camera position

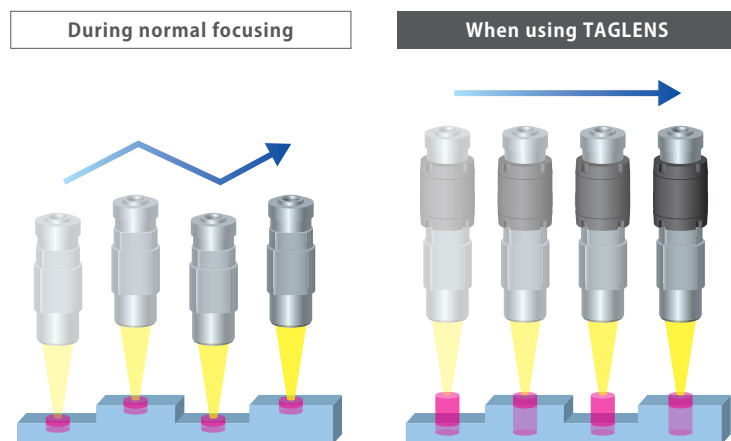

Until now, imaging for subjects with differing heights and depths was performed by taking multiple photographs while moving the camera vertically (Z-axis motion). In contrast, TAGLENS is able to focus on subjects with multiple different heights and depths simultaneously, and can be effective on production lines where products are in motion.

SOFTWARE

TAGPAK-C Supplied as standard

TAGPAK-C software* controls the TAGLENS controller. The software communicates with the TAGLENS controller and conducts the drive start and stop, frequency setting, amplitude setting and resonance lock.

* This software is required when using TAGLENS-T1.

Items		System specifications
OS		Windows10 Pro 64 bit
CPU	Clock frequency	2.0 GHz or more
	Memory	8 GB or more
PC	Hard disk	25 GB or more
	Optical Drive	DVD-ROM Drive for installation software.
	Communication port TAGLENS control	USB 2.0 x 1 port and RS-232C x 1 port
Monitor		SXGA (1280x1024 Pixel) or more

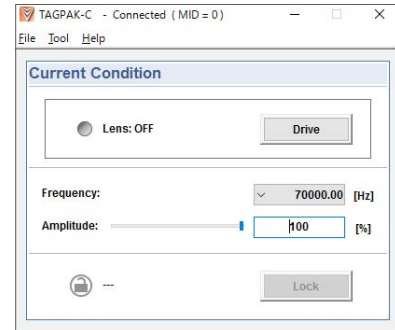

<TAGPAK-C operation screen>

TAGPAK-E Optional Software (Required for checking the inspection images.)

TAGPAK-E software converts images captured by the optical system using TAGLENS for extended depth of field (EDOF) images. The software provides functions relating to EDOF images such as parameter setting, image ON/OFF and saving and loading the images.

[Execution example of EDOF image]

Normal microscope observation

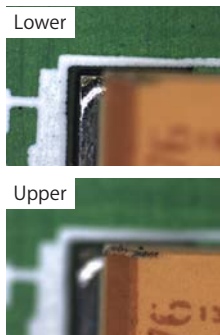

With a height difference, only the upper or lower plane can be focused.

When using TAGLENS

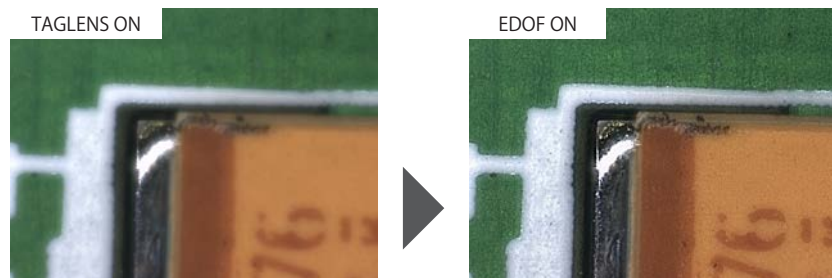

TAGLENS changes the focus point at high speed. However, because the capturing time per frame is longer than the focusing time, the images will have optically mixed focus points from different heights, and the image will be blurred.

Eliminate the blurriness caused by a change in the optical system or focus position, and you obtain an entirely sharper image. This is called the EDOF image.

Items		System specifications
OS		Windows10 Pro 64 bit
TAGLENS control software		TAGPAK-C Ver.1.0
CPU	Clock frequency	2.0 GHz or more
	Number of physical cores	4 cores or more (Recommendation: 8 cores or more)
Memory		8 GB or more
	Hard disk	25 GB or more
PC	Optical Drive	DVD-ROM Drive for installation software.
	TAGLES control	USB 2.0 x 1 port and RS-232C x 1 port
Communication port	GigE Vision control	1000BASE-T x 1 port
	USB3 Vision control	USB 3.0 x 1 port
	Dongle	USB 2.0 x 1 port
Monitor		SXGA (1280x1024 Pixel) or more

Two filters, the binarization filter and the Sobel* filter, are available for the image displayed on the viewer.

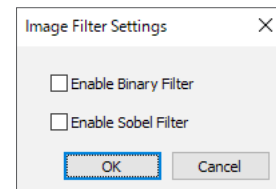

* A filter function to emphasize a contour.

Note: For both TAGPAK-C and TAGPAK-E, some functions are available as SDK, enabling their integration into your software.

SPECIFICATION

TAGLENS-T1

Ultra-high speed, varifocal lens.
A dedicated controller is equipped as standard.

Resonance frequency	70 kHz
Effective aperture	ø11 mm
Transmittance	90% or more (λ 400 nm to 700 nm)
Refractivity range	0.7 D to 1 D
Mountable posture	All directions
Accuracy guaranteed temperature range	15 °C to 30 °C
Operating Environment / Humidity	10 °C to 40 °C / 40% to 70% RH or less (non-condensing)
Storage Environment / Humidity	-10 °C to 50 °C / 80% RH or less (non-condensing)
Mass	Approx. 0.6 kg



■ Dimensions

Unit: mm

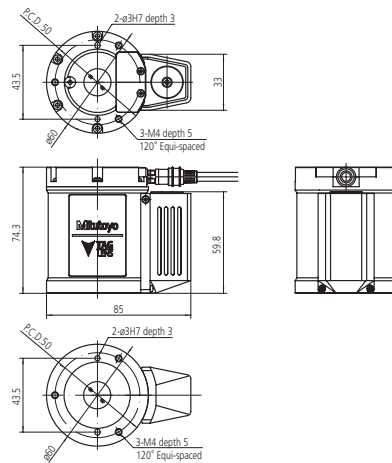

Controller

The controller supplies power to the TAGLENS main unit and controls the lens main unit via TAGPAK-C. Other than the connector to the main unit, output connectors for synchronization with external devices are equipped. The AC adapter supplied should be used to supply power to the controller.

Dimensions	144.2 mm × 107 mm × 51.2 mm
Mass	Approx. 0.4 kg
Distribution method	Single phase 2-wire system / 1-wire grounding
Power supply voltage	AC 100 V to 240 V 50 Hz / 60 Hz
Power consumption	Max. 20 W



■ Dimensions

Unit: mm

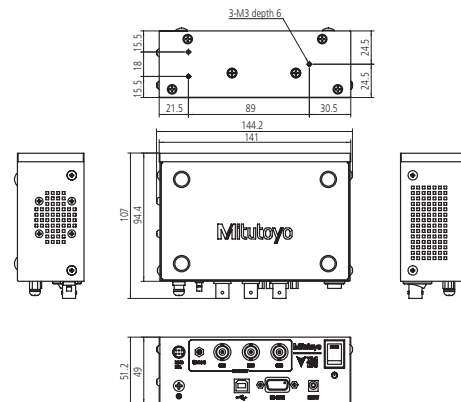

① Lens driving signal output terminal	For connecting to TAGLENS.
② Camera trigger output terminal	An SMB connector to control an externally connected camera. It outputs the signals synchronized with the TAGLENS drive signals.
③ External trigger output terminal (CH1)	A BNC connector to control the externally connected devices. It outputs the signals synchronized with the TAGLENS drive signals.
④ External trigger output terminal (CH2)	
⑤ External trigger output terminal (CH3)	
⑥ Ground terminal	A protection ground terminal.
⑦ USB connector	Connects the PC and the main unit with a USB cable.
⑧ RS-232C connector	Connects the PC or other measuring equipment and the main unit with an RS-232C cable.
⑨ Connector for power supply	A jack to connect the AC adapter.

Video Microscope Unit VMU-T1

TAGLENS-T1 is installed in the microscope unit. Incorporating the objective lens and the camera enables configuring a varifocal optical system.



Compatible TAGLENS	TAGLENS-T1
Imaging lens magnification	1X
Imaging area	ø11 mm
Applicable objective lenses	M Plan Apo Series
Options	Manual turret, Power turret, Polarizer and Analyzer, Focusing unit, X-Y stage, Simple stand

■ Dimensions

Unit: mm

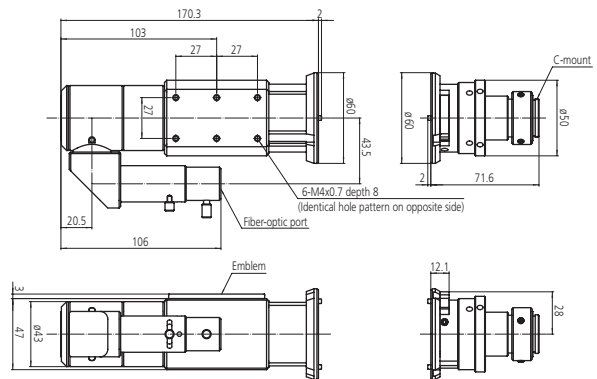

■ Variable focal length range

Objective lens	M Plan Apo Series						
	1X	2X	5X	7.5X	10X	20X	50X
Depth of focus × 2 (mm)	0.88	0.18	0.028	0.012	0.007	0.003	0.0018
Total scanning depth (mm)	16	4	0.64	0.28	0.16	0.04	0.007
Real FOV (mm)	4.8 × 6.4	2.4 × 3.2	0.96 × 1.28	0.64 × 0.85	0.48 × 0.64	0.24 × 0.32	0.096 × 0.128
Real FOV (mm)	6.6 × 8.8	3.3 × 4.4	1.32 × 1.76	0.88 × 1.17	0.66 × 0.88	0.33 × 0.44	0.132 × 0.176

Note: M Plan Apo HR Series is not supported.

[System diagram]

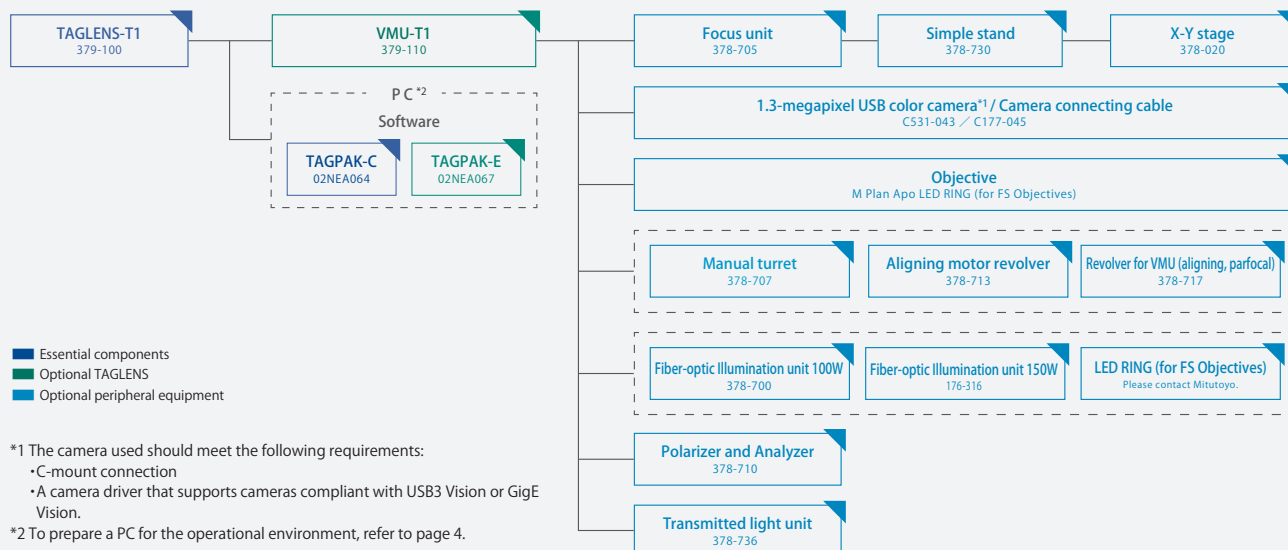

- Essential components
- Optional TAGLENS
- Optional peripheral equipment

*1 The camera used should meet the following requirements:
 • C-mount connection
 • A camera driver that supports cameras compliant with USB3 Vision or GigE Vision.

*2 To prepare a PC for the operational environment, refer to page 4.



Whatever your challenges are, Mitutoyo supports you from start to finish.

Mitutoyo is not only a manufacturer of top-quality measuring products but one that also offers qualified support for the lifetime of the equipment, backed by comprehensive services that ensure your staff can make the very best use of the investment.

Apart from the basics of calibration and repair, Mitutoyo offers product and metrology training, as well as IT support for the sophisticated software used in modern measuring technology. We can also design, build, test and deliver measuring solutions and even, if deemed cost-effective, take your critical measurement challenges in-house on a sub-contract basis.



Find additional product literature and our product catalog

www.mitutoyo.com

Note: All information regarding our products, and in particular the illustrations, drawings, dimensional and performance data contained in this printed matter as well as other technical data are to be regarded as approximate average values. We therefore reserve the right to make changes to the corresponding designs. The stated standards, similar technical regulations, descriptions and illustrations of the products were valid at the time of printing. In addition, the latest applicable version of our General Trading Conditions will apply. Only quotations submitted by ourselves may be regarded as definitive. Specifications are subject to change without notice.

Mitutoyo products are subject to US Export Administration Regulations (EAR). Re-export or relocation of our products may require prior approval by an appropriate governing authority.

Trademarks and Registrations

Designations used by companies to distinguish their products are often claimed as trademarks. In all instances where Mitutoyo America Corporation is aware of a claim, the product names appear in initial capital or all capital letters. The appropriate companies should be contacted for more complete trademark and registration information.



Mitutoyo America Corporation

www.mitutoyo.com
 One Number to Serve You Better
 1-888-MITUTOYO (1-888-648-8869)

M³ Solution Centers:

- Aurora, Illinois (Headquarters)
- Boston, Massachusetts
- Charlotte, North Carolina
- Cincinnati, Ohio
- Detroit, Michigan
- Los Angeles, California
- Birmingham, Alabama
- Seattle, Washington
- Houston, Texas