

Mitutoyo

Mitutoyo Quality

Electronic Micrometer Mu-Checker

SENSOR SYSTEMS



Bulletin No. 2215(2)

Mitutoyo Electronic Micrometers Adaptable Suited to a Wide Application Range from a Production Line!

A low-measuring-force sensor enables even a soft workpiece to be measured without significant deformation.



Standard type measuring force: 0.2N (No. 519-521)



Low-force type measuring force: 0.02N (No. 519-522)

Compact models are best suited for in-line use.



No. 519-346



No. 519-347

Analog and digital indicator units are both equipped with a Zero-setting function.



No. 519-552A



No. 519-562A

to Customer Demands the Inspection Room to Building into

Measurement Principle

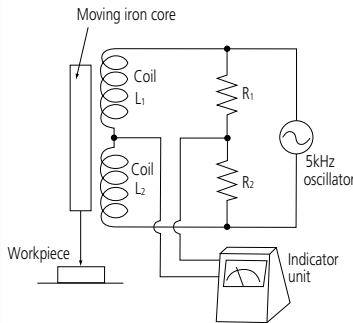

This instrument uses a differential inductance displacement sensor energized by a 5kHz AC exciting voltage applied across two identical series-connected coils, L1 and L2. An iron core connected to the stylus moves close to both cores and varies the impedance of each coil depending on its position, and the voltage at the junction between the coils varies as the impedance difference. Two resistors, R1 and R2, form a bridge circuit with the coils and the bridge output voltage drives electronic amplification and conditioning circuits to provide a voltage signal proportional to displacement of the stylus.

Mu-checker Block Diagram

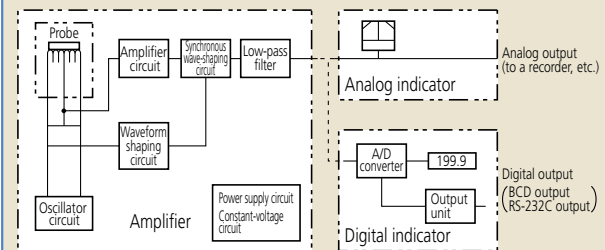

Applications

Measuring runout

The distortion of a core is measured with lever head **No. 519-522** and Mu-checker **No. 519-552A**.

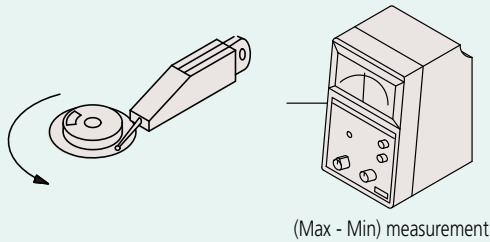

Measuring the inclination of a pin

The inclination of a capstan pin is measured with cartridge head **No. 519-385** and digital Mu-checker **No. 519-562A**.

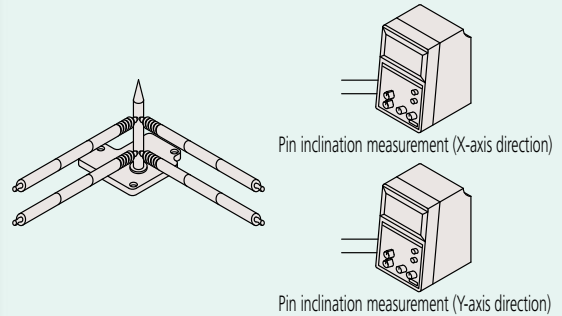

Measuring the thickness of rolled sheet

The thickness of a rolled sheet material is measured with lever head **No. 519-521** and Mu-checker counter **EV-16A**.

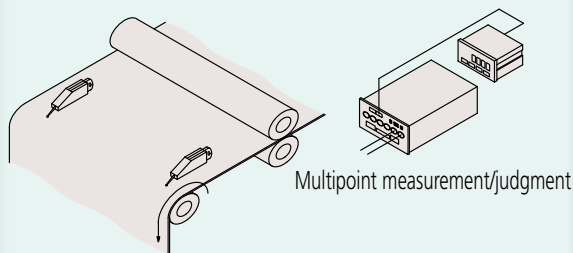

Measuring the maximum runout of a gear

The maximum runout of a gear is measured with lever head **No. 519-521** and Mu-checker counter **EV-16A**.

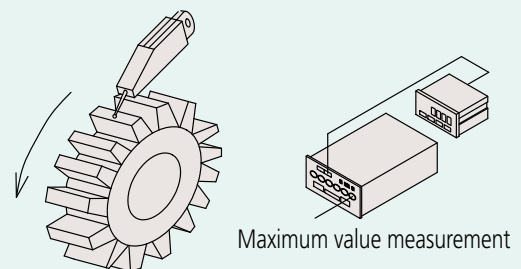

Measuring straightness of sheet metal

The straightness of a component is measured with cartridge head **No. 519-385** and Mu-checker **No. 519-552A**.

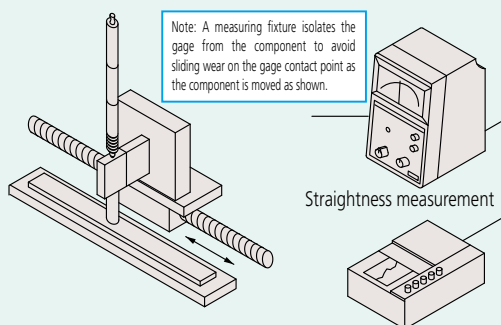

Multipoint measurement on a VTR chassis

A VTR chassis is measured at multiple points with cartridge head **No. 519-385** and Mu-checker counter **EV-16A**.

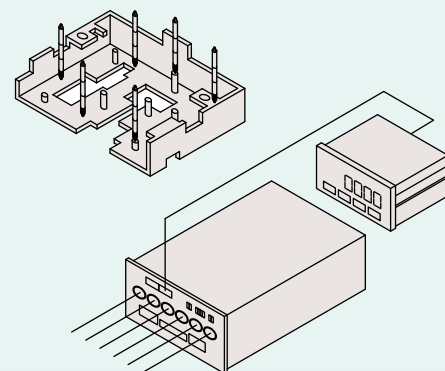

Measuring the pitch of HDD head components

The pitch of HDD detector head components is measured with lever head **No. 519-521** and Mu-checker counter **EV-16A**.

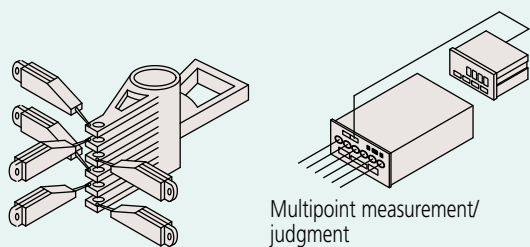

Measuring the concentricity of a shaft

The concentricity and runout of a shaft are measured with cartridge head **No. 519-385** and Mu-checker counter **EV-16A**.

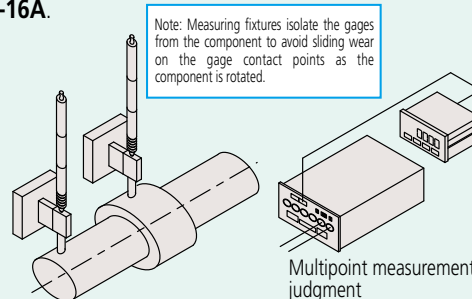

Measuring the inside width of a wheel

The inside width of a car wheel is measured with lever head **No. 519-521** and digital Mu-checker **No. 519-562A**.

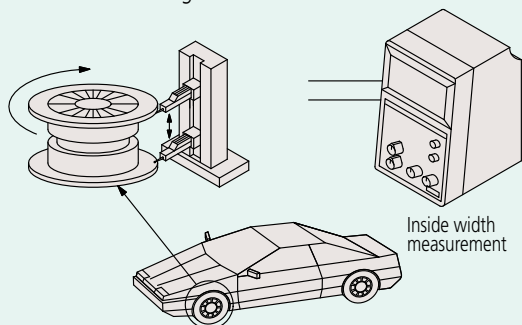

Measuring the height of a piston head

The height of a piston head is measured with cartridge head **No. 519-385** and Mu-checker counter **EV-16A**.

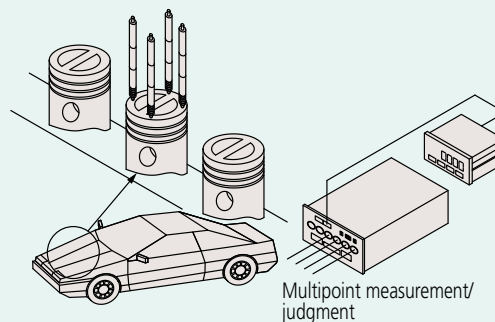

Measuring the pitch and runout of slitter blades

The pitch and runout of slitter blades are measured with lever head **No. 519-521** and Mu-checker counter **EV-16A**.

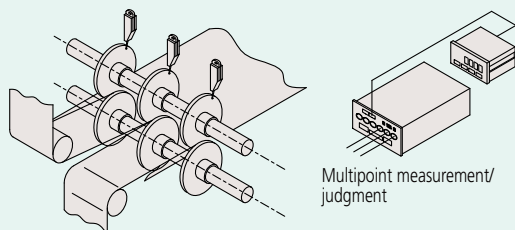

Measuring the warp on an LCD panel

The warp of an LCD panel is measured with lever head **No. 519-522** and Mu-checker **No. 519-552A**. This lever head with a low measuring force allows measurement without scratching the workpiece.

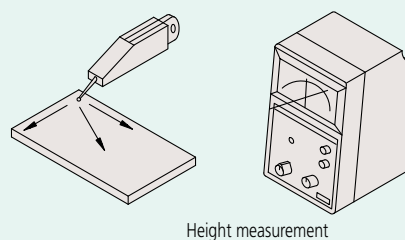

Mu-Checker System Diagram



Lever Head
No. 519-327
±0.5mm P8



Lever Head
No. 519-521
±0.5mm P8



Lever Head
No. 519-522
±0.5mm P8



Lever Head
No. 519-328
±0.5mm P8



Cartridge Head
No. 519-331
No. 519-332
±0.5mm P10



Cartridge Head
No. 519-346
±0.25mm P10



Cartridge Head
No. 519-347
±0.5mm P10



Cartridge Head
No. 519-385
±1.5mm P10



Cartridge Head
No. 519-341
±2.5mm P10



Cartridge Head
No. 519-348
±1.0mm P10



Standard type
Mu-Checker
No. 519-552A P14



Differential type
Mu-Checker
No. 519-554A P14



Digital differential type
Mu-Checker
No. 519-562A
(with Digimatic output) P15



Mu-Checker Counter
EV-16A
No. 519-355 P16

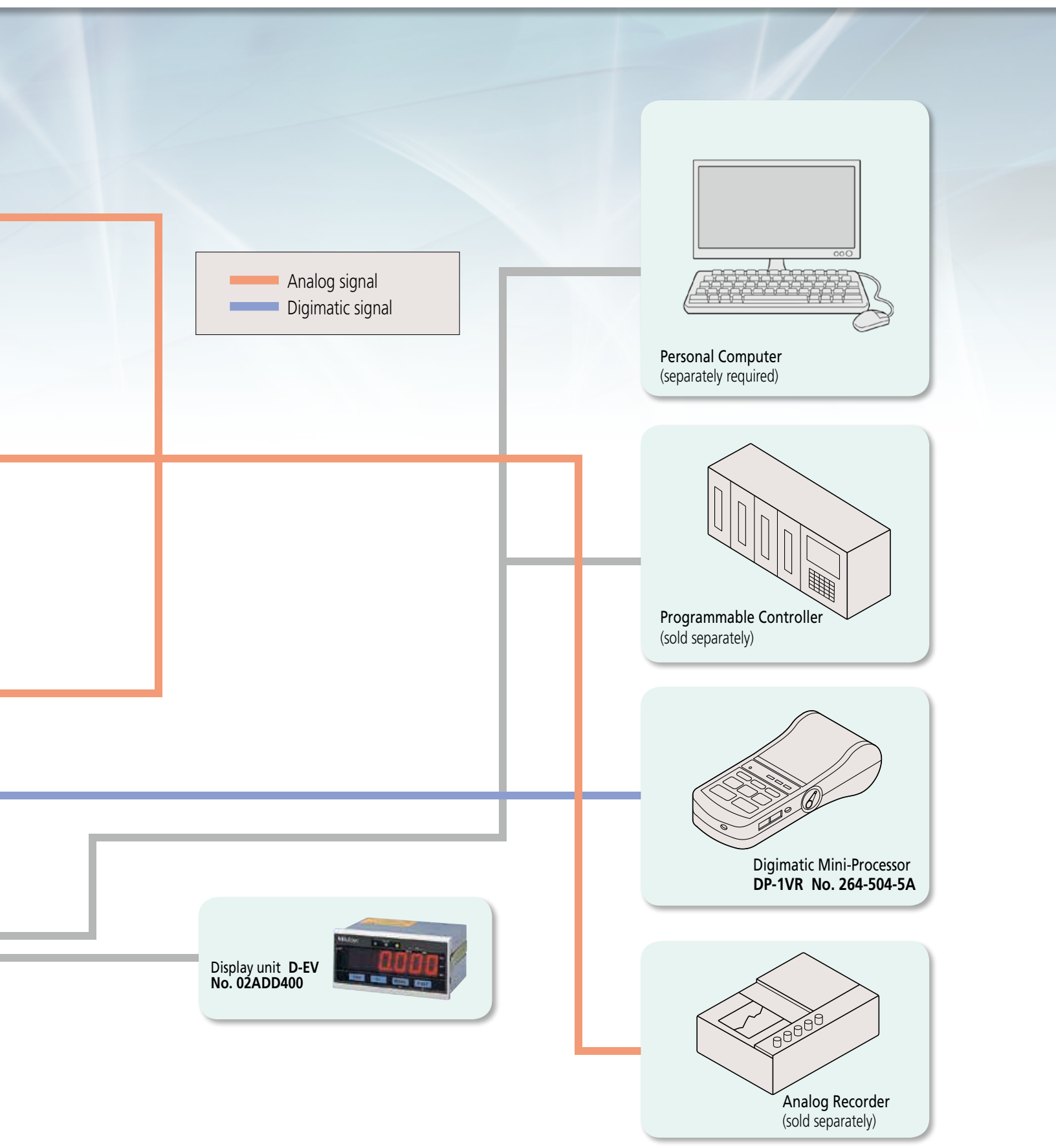

— Analog signal
— Digimatic signal

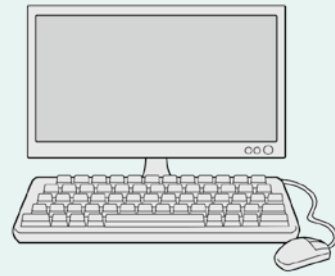

Personal Computer
(separately required)

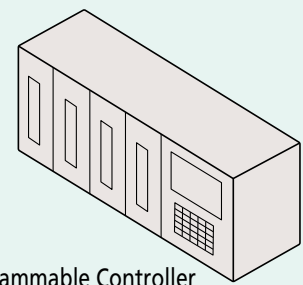

Programmable Controller
(sold separately)

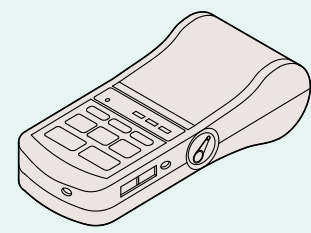

Digimatic Mini-Processor
DP-1VR No. 264-504-5A



Display unit D-EV
No. 02ADD400

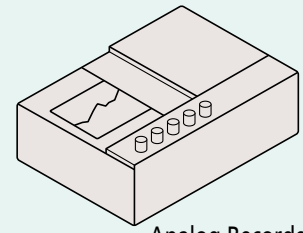





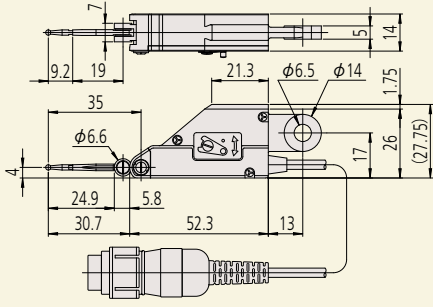

Analog Recorder
(sold separately)

Probes

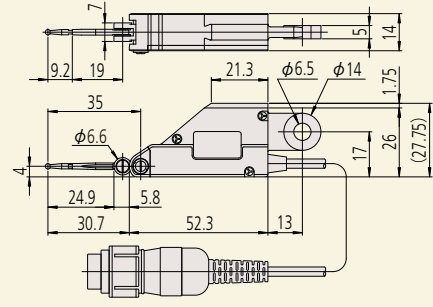
Lever Head Type This type allows multipoint measurement of small parts, flatness and straightness measurement on an XY table, etc. and runout measurement of shafts.

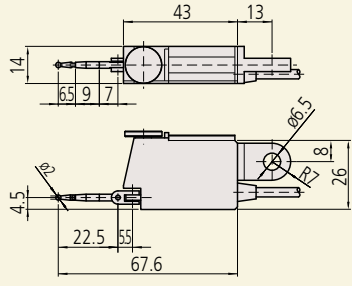
Specifications

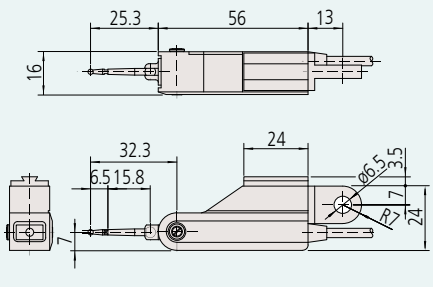
Order No.		External dimensions [mm]	Measuring range [mm]	Stylus stroke [mm]
No. 519-521				
No. 519-522			±0.5	±0.6
No. 519-326				
No. 519-327			±0.5	±0.65

Measuring force	Linearity [%]	Bearing unit structure	Remarks/ Interchangeable stylus
Approx. 0.2N	±0.3	Pivot bearing type	Measuring direction changed with the forward reverse lever No. 520940 (ø1) No. 520939 (ø2) No. 520938 (ø3)
Approx. 0.02N		Pivot bearing type	Low measuring force No. 520940 (ø1) No. 520939 (ø2) No. 520938 (ø3)
Approx. 0.15N		Parallel leaf spring type	The measuring force is adjustable with the upper dial. No need for displayed value correction when stylus makes an angle with surface No. 102824 (ø1) No. 102832 (ø2) No. 102826 (ø3) Note: Only the ø2 stylus tip is a standard accessory.
Approx. 0.15N	±0.5	Pivot bearing type	No need for change of measuring direction due to no-clutch type No. 102824 (ø1) No. 102832 (ø2) No. 102826 (ø3) Note: Only the ø2 stylus tip is a standard accessory.

Note on stylus angle

If the stylus of a pivot bearing type probe (No. 519-521, No. 519-522, or No. 519-327) makes an angle with a workpiece surface, as in the figure, calibration should be performed for accurate measurement. Alternatively, the displayed value may be corrected by multiplying it by the appropriate correction factor as given in the table.

Angle θ	Correction factor
0°	1.00
10°	0.98
20°	0.94
30°	0.87
40°	0.77
50°	0.64
60°	0.50

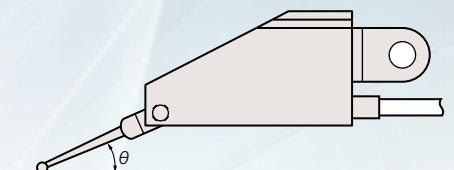

Display value x Correction factor = Corrected value

Dimensions of Dovetail Plate on probe body

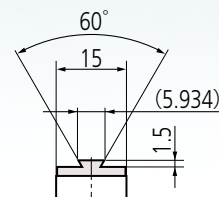

Transfer Stand



No. 519-109-10
(with a serrated anvil)

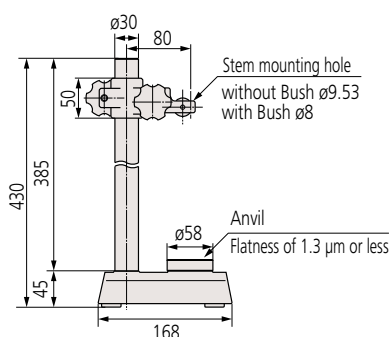

Major Specifications

Order No.	Effective transfer range [mm]	Fine adjustment range [mm]	Mounting hole [mm]
519-109-10	0-320	1	ø9.53, ø8 with Bush

Lever Head Mounting Brackets (Option)

<p>Stem</p> <p>ø4 dovetail-grooved stem No. 902802</p> <p>ø6 dovetail-grooved stem No. 902803</p>	<p>Clamp</p> <p>Clamp for ø6/ø8 dovetail-grooved stem No. 902053</p> <p>Clamp for ø6/ø9.5 dovetail-grooved stem No. 900320</p>	<p>No. 902053</p>
<p>Holder</p> <p>Holder arm A (square 9x9x100) No. 900209</p> <p>Holder arm B (ø8x115) No. 900211</p>	<p>.25" x .5"</p> <p>953639 (Length: 2") 900306 (Length: 4")</p>	

Cartridge Head Type

A cartridge head type is easily built-in to the equipment due to its slim and compact shape. This type of sensor is optimal for an automatic measuring machine.

Specifications

Order No.		External dimensions [mm]	Measuring range [mm]
No. 519-331 No. 519-332		<p>* for 519-332: (ø) .375" stem, 4-48UNF contact point</p>	±0.5
No. 519-346			±0.25
No. 519-347			±0.5
No. 519-385			±1.5
No. 519-341			±2.5
No. 519-348			±2.5

Common Specifications

Connection method _____ Half-bridge type
 Exciting voltage _____ 3.0VRMS
 Exciting frequency _____ 5kHz
 Exciting waveform _____ Sinusoidal

Cord length _____ 2m
 Cord thickness _____ ø4mm
 Connector type _____ Mas-5100 (DIN5P)

	Maximum stylus stroke [mm]	Measuring force	Linearity [%] *	Dust-proof rubber boot	Bearing unit structure	Remarks/Interchangeable stylus	
	±0.65	0.25N	±0.5	No	Plain type	Low measuring force	Accepts interchangeable styli for dial indicators M2.5×5
	+0.34 -0.26	0.7N	±0.3	No	Linear ball bearing type	Compact type Suitable for inside-diameter measurement	Dedicated stylus used Non-interchangeable
	+0.85 -0.65	0.7N	±0.3	Yes	Linear ball bearing type	Compact type	
	+2.35 -1.65	0.7N	±0.3	Yes	Linear ball bearing type	Standard type with cable strain-relief	Accepts interchangeable styli for dial indicators M2.5×5
	+3.2 -2.8	0.9N	±0.5	Yes	Linear ball bearing type	Standard type	
	+1.35 -1.15	0.7N	±0.3	Yes	Linear ball bearing type	Standard type with cable strain-relief	

* Indicates a value with respect to that at full scale.

Styli/Extension Rods (interchangeable styli for dial indicators are usable)

- All threaded portions are M2.5x0.45 x 5mm.
- When exchanging a stylus, firmly tighten the screw so it will not loosen during use. (Recommended tightening torque: 5N·cm)
- Carbide styli are resistant to abrasion.

Ball point

Standard styli are provided.

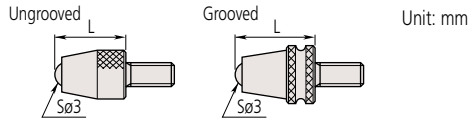

Note: A tip ball of $\phi 0.5$ to 10 is available by special order.

L	Ball material	Carbide		Ruby	Nylon
		Ungrooved	Grooved (Waterproof)	Ungrooved	Ungrooved
7.3	Order No.	901312	–	120047	901994
8.3	Order No.	–	902119	–	–
12.1	Order No.	–	21AZA320	–	–
14	Order No.	21JAA225	–	–	–
15	Order No.	120049	–	120051	–
17	Order No.	21JAA224	–	–	–
19.3	Order No.	–	21AZA321	–	–
20	Order No.	137391	–	137392	–
22	Order No.	21JAA226	–	–	–
25	Order No.	120053	–	120055	–
30	Order No.	21AAA252	–	21AAA253	–

Note: If a probe using the flat point stylus requires squareness to the stem and parallelism with the reference plane, these must be adjusted including the cartridge head before use. Please consult Mitutoyo for special orders.

Spherical point (Carbide)

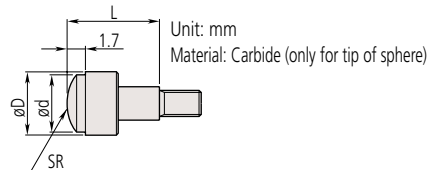

Note: A spherical point with ϕD of up to 40 is available by special order.

L	D	$\phi 5.2$	$\phi 7.5$	$\phi 10.5$
		($\phi 4.3 \times 5$)	($\phi 6.5 \times 10$)	($\phi 9.5 \times 10$)
SR		5	7	10
5	Order No.	120058	–	–
10	Order No.	–	120059	120060

Shell type point

Provided with a large spherical point. This stylus is convenient for plane measurement.

Note: A shell type point with ϕD of 0.5 to 40, SR of 0.2 or more and L of up to 100 is available by special order.

ϕD	SR	L	Order No.
5	2.5	5	101386
		10	101118
		12	137393
		20	101387
		25	101388
30	21AAA254		

Unit: mm
Material: Hardened steel

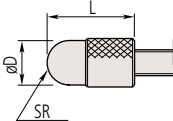

Ball point

Convenient for measuring an indentation.

SøD	ød	Order No.
1	5	21AAA349
1.5		21AAA350
1.8		101122
2.5		21AAA351
4		21AAA352

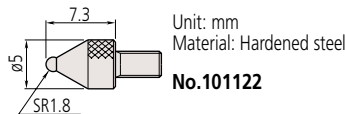

* A tip ball of $\phi 0.5$ to 10 is available by special order.

Flat point

Convenient for measuring a workpiece with a spherical measuring surface.

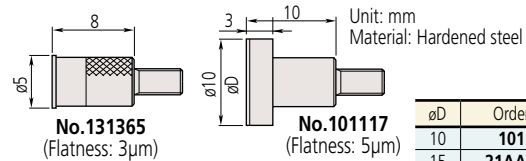

No.131365
(Flatness: 3 μ m)

No.101117
(Flatness: 5 μ m)

L	Order No.
8	13165
10	21AAA340

øD	Order No.
10	101117
15	21AAA341
20	21AAA342
25	21AAA343
30	21AAA344

Note: A flat point diameter (ϕD) of up to 50 is available by special order.

Note: If a probe using the flat point stylus requires squareness to the stem and parallelism with the reference plane, these must be adjusted including the cartridge head before use. Please consult Mitutoyo for special orders.

Flat point (Carbide)

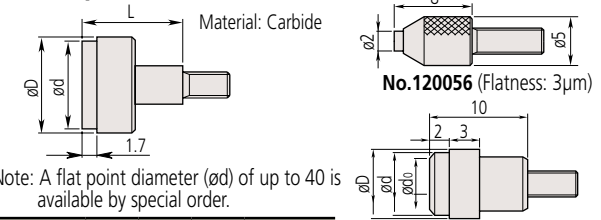

No.120056 (Flatness: 3 μ m)

Note: A flat point diameter (ϕD) of up to 40 is available by special order.

Order No.	d	D	L	Flatness(μ m)
120041	4.3	5.2	5	3
120042	6.5	7	5	
120043	9.5	10.5	5	
21AAA345	15	17	10	5
21AAA346	20	22		
21AAA347	25	27		
21AAA348	30	32		

d ₀	ø3	ø4.5
d	ø6.4	ø8
D	ø7	ø9
Order No.	137255	137399

(Flatness: 3 μ m)

Note: If a probe using the flat point stylus requires squareness to the stem and parallelism with the reference plane, these must be adjusted including the cartridge head before use. Please consult Mitutoyo for special orders.

Needle point

Convenient for measuring the bottom face of a groove or hole.

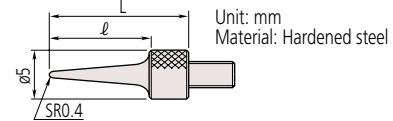

Note: A needle point with SR of 0.2 and ℓ of up to 20 is available by special order.

Order No.	ℓ	L
101121	11	15
137413	13	17
21AAA255	21	25
21AAA256	31	35

Needle point (Carbide)

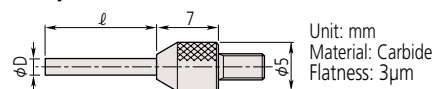

D	3	5	8	10	13	18	20	28	40
ø0.45	Order No.	120066	21AAA329						
ø1	Order No.	120065	21AAA330	21AAA331	21AAA332		21AAA333		21AAA334
ø1.5	Order No.		21AAA335		21AAA336	120064	21AAA337		21AAA338
ø2	Order No.			137257			21AAA257	21AAA258	21AAA339

Note: Consult Mitutoyo for the specifications of products shown in the table above.

Note: If a probe using the flat point stylus requires squareness to the stem and parallelism with the reference plane, these must be adjusted including the cartridge head before use. Please consult Mitutoyo for special orders.

Conical point

Used for positioning a measuring point accurately. The stylus is not suitable for measuring a soft workpiece since its tip easily scratches the workpiece.

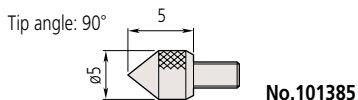
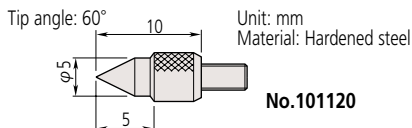

Conical point (Carbide)

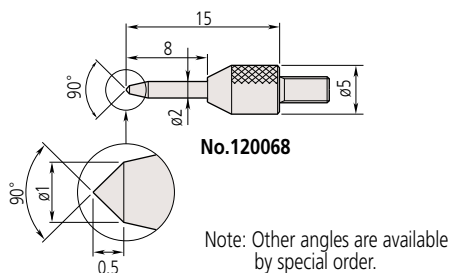
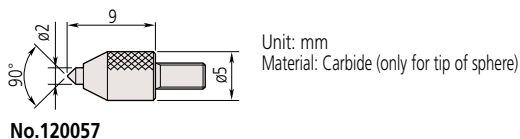

Knife-edge point (Carbide)

Convenient for measuring a narrow groove diameter.

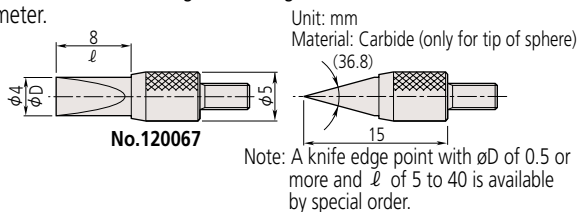

Note: If a probe using the knife-edge point stylus requires squareness to the stem, parallelism with the reference plane and stylus orientation, these must be adjusted including the cartridge head before use. Please consult Mitutoyo for special orders.

Spherical point

Convenient for sliding a workpiece under the point from the side since it has a large spherical face.

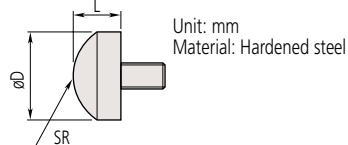

L	D	D		
		ø5.5	ø7.9	ø10
SR		5	5	7
3	Order No.	111460	-	-
5	Order No.	-	125258	101119

Blade point (Carbide)

Convenient for measuring a cylindrical workpiece.

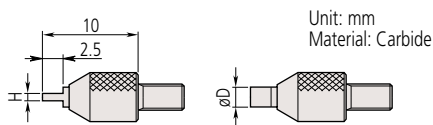

Note: A blade point with H of 0.4 or more and D of ø0.5 or more is available by special order.

L	D	D		
		0.4	0.6	1
ø2	Order No.	120061	120062	-
ø4	Order No.	-	-	120063

Note: If a probe using the blade point stylus requires squareness to the stem, parallelism with the reference plane and stylus orientation, these must be adjusted including the cartridge head before use. Please consult Mitutoyo for special orders.

Roller point

Convenient for measuring a moving workpiece such as rolled strip. The stylus is also convenient for sliding a workpiece under the roller point from the side.

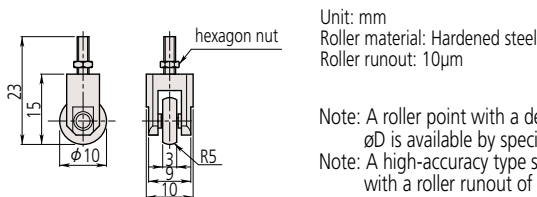

Note: A roller point with a desired øD is available by special order. Note: A high-accuracy type stylus with a roller runout of 5 µm is also available. (special order)

Extension rod

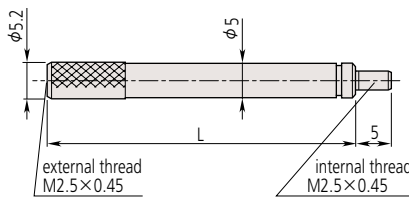

L	Order No.	L	Order No.
10	303611	55	21AAA259G
15	21AAA259A	60	304146
20	303612	65	21AAA259H
25	21AAA259B	70	21AAA259J
30	303613	75	21AAA259L
35	21AAA259C	80	21AAA259M
40	21AAA259D	90	304147
45	21AAA259E	100	303614
50	21AAA259F		

Mu-checkers

- Zero-setting can be performed with a single touch of a button. A Mu-checker can be combined with peripheral devices because zero-setting is enabled with an external signal input.

Analog Type

- Easy to read, highly responsive



Differential type analog Mu-Checker
(for step and sheet thickness measurement)
No. 519-552A

Differential type analog Mu-Checker
(for step and sheet thickness measurement)
No. 519-554A

Common Specifications

Indication accuracy	±1%/± full scale
Analog output accuracy	±0.1%± within full scale (excluding the probe)
Analog output	±1V± full scale
Meter indication response	Approx. 0.3s
Zero-setting enabled zone	1/3 scale or less (CMP mode)
Zero point thermal coefficient	100ppm/°C or less
Sensitivity thermal coefficient	100ppm/°C or less
Power consumption	5VA or less
Operating temperature range (°C)	0 to 40
Storage temperature range (°C)	-10 to 50
Power supply	120VAC
External dimensions (mm)	134 (W) × 210 (H) × 183 (D)
Measuring range (μm)	±1500, 500, 150, 50, 15, 5
Minimum reading (μm)	50, 10, 5, 1, 0.5, 0.1
Measuring range (in)	±.05, ±.015, ±.005, ±.0015, ±.0005, ±.00015
Minimum reading (in)	.001", .0005", .0001", .000050", .000010", .000005"

Individual Specifications

Order No.	519-552A	519-554A
Calculation mode	±A	Yes
	±B	—
	±A±B	—
Tolerance judgment	—	—
Tolerance judgment output	—	—
Tolerance judgment output mode	—	—
Number of connectable probes	1	2
Mass	1.7kg	1.8kg

• Special Options

	Description/Illustration	Analog type	Digital type	EV-16A
Digimatic mini processor No. 264-504-5A	DP-1VR		○	
DP-1VR connecting cable No. 936937			○	
Analog output cord A No. 934795		○	○	
External output connector No. 529035	Analog, limit output (7P)	○	○	
Extension cord A No. 934386	Extension cord (5m) to enable probe and indicator to be separated	○	○	○

Note: Items marked with ○ are optional accessories.

Digital Type

- Easy-to-read, digital readout
- A measurement data output function is standard, allowing connection to various processors.
- Dual input

Differential type digital Mu-Checker
(for step and sheet thickness measurement)
No. 519-562A



Specifications

Order No.	519-562A
Readout range	High: $\pm 2.000\text{mm} / \pm .08''$ Low: $\pm 0.2000\text{mm} / \pm .008''$
Resolution	On High range: $0.001\text{mm} / \pm .000010''$ On Low range: $0.0001\text{mm} / \pm .000001''$
Calculation mode	$\pm A, \pm B, \pm A \pm B$
Measurement mode	ABS/CMP
Zero-setting enabled zone LL: 1/3 scale or less, H: Full scale	60
Indication accuracy	3 LCD
Operating temperature range (°C)	0 to 40
Storage temperature range (°C)	-10 to 50
Analog output	$\pm 1\text{V} / \pm \text{FS}$
Analog output accuracy	$\pm 0.1\%$ or less
Digital output	Digimatic code format
Digital output mode	1 ch
Power consumption	5VA or less
External dimensions (mm)	134 (W) x 183 (H) x 210 (D)
Power supply	120 VAC

Digital Output Connector

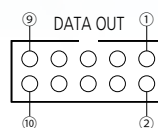

PIN No.	Signal
1	GND
2	DATA
3	CK
4	NC
5	REQ
6	NC

(1) Digimatic code format

A data string for each measurement consists of 13 digits (d1 to d13), assigning 4 bits to 1 digit. data strings are output as 1 set according to the timing.

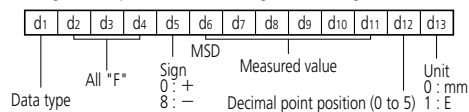

(2) Timing chart

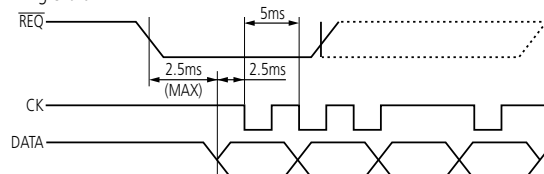

Analog Output Connector Pin Assignment and Interface

Analog output connector

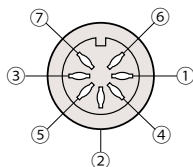

Pin No.	Signal name
①	+NG output
②	HOLD input (tolerance judgment result hold)
③	Analog output $\pm 1\text{V}$
④	0V (logic GND)
⑤	0V (analog GND)
⑥	-NG output
⑦	ZERO SET

Applicable plug: No. 529035 (Option)

Signal name	Mu-checker I/O interface	Driving circuit and recommended load	Timing
Analog output			
ZEROSSET			
HOLD			
\pm NG output			

Mu-Checker Counter EV-16A



External dimensions

Unit: mm

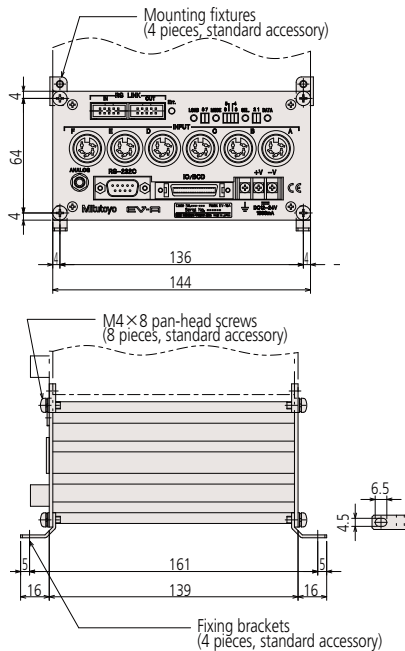

Features

- The EV-16A allows 6 probes to be connected unit simultaneously. one unit. The use of the RS link enables easy construction of a multi-point measuring system that allows a maximum of 10 units (60 probes).
- I/O outputs such as RS-232C, BCD, tolerance judgment and segment are selectable.
- Peak measurement and arithmetic operation between axes (in the same unit) are also possible in addition to normal measurement for each axis.

Major Functions

- External control (zero-setting, presetting, etc.)
- Direction switching
- Error messaging
- Tolerance judgment output
- Various data output (RS-232C, BCD, segment)
- Peak measurement (maximum value, minimum value, runout) and arithmetic operation (addition, average, maximum value, minimum value, maximum width) between axes

Specifications

Order No.	519-355	
Model No.	EV-16A	
Number of input probes	6 axes	
Quantizing error	±1 LCD	
Resolution [mm] (): Max. counting range	0.001(±2.000mm), 0.0001(±0.200mm)	
LED display	Parameter display: 8 digits (setting display), error message: 1 digit	
Error message	Power supply voltage error, probe malfunction, etc.	
External display	Dedicated external display unit: D-EV (special option) connectable	
Number of input switches	4	
Input switch function	Measurement mode selection, parameter setting	
Input/Output	Tolerance judgment output	1 to 6 axes (L1, L2, L3), open collector
	BCD output	BCD parallel output (positive-true logic/negative logic), open collector
	Segment output	Function to turn output ON only for the terminal corresponding to the count value, open collector
	Control output	Normal operation signal (Normal), open collector
	Control input	Output channel designation (upon segment output or in the BCD mode), presetting, peak clear, range selection (upon segment output), count value hold, open-collector or no-voltage contact signal (contact/noncontact)
Interface	RS-232C	Measured data output and control input, compatible with EIA RS-232C
	RS link	Home position DTE (terminal definition): Use a crossover cable. Maximum number of connectable units: 10 Connecting cable length: Up to 10m (total length of all linked cables) Data transmission time: 1.1 sec/60CH (at a baud rate of 19200bps)
Rating	Power supply voltage	Terminal board (M3 screws), +12 to 24VDC
	Consumption current	1A
Operating temperature (humidity) range	0 to 40°C (20 to 80%RH, non condensing)	
Storage temperature (humidity) range	-10 to 50°C (20 to 80%RH, non condensing)	
External dimensions	144(W)×72(H)×139(D)mm	
Mass	Approx. 1000g	
Standard accessories	Fixing bracket (4), mounting fixture (4), mounting screw M4×8 (8)	
Optional accessories (custom-ordered)	I/O output connector (No. 02ADB440) D-EV external unit (No. 02ADD400) RS-link connecting cable 0.5m (No. 02ADD950) RS-link connecting cable 1m (No. 936937) RS-link connecting cable 2m (No. 965014)	
Applicable probes	Lever head, cartridge head	

*1. To calibrate the EV-16A properly, be sure to purchase dedicated display unit D-EV. When multiple units of EV-16A units are to be used, at least one D-EV unit is required.

*2. As a power supply is not supplied as standard, an appropriate power supply with a current capacity of 1A or more must be provided for each EV-16A.

Display unit for the EV counter

Display Unit D-EV

- This display unit allows an EV-16A to be set up without using a PC.
- D-EV** can display each axis measurement value, go/no go judgment results, setting data, go/no go judgment bars of all axes and error messages.

Specifications

Connecting condition	Allows external display and setting control of one EV-16A unit.
Number of displayed digits	Sign + 6 digits (EV-16-A processes 8-digit data internally)
LED display	Channel display (shared with judgment result display): 3 digits (3 color LEDs) Measurement mode (current value, maximum value, minimum value, runout) display: 2 digits Status display: 1 digit (2 colors)
Operation switch	4
Operation switch function	Channel selection, measurement mode selection (current value, maximum value, minimum value, runout), parameter setting, presetting and tolerance limit setting
Input/output	RS-link connector IN, OUT each 1
Error message	Power supply voltage error, probe malfunction, etc.
Power supply	Terminal board (M3 screws), +12 to 24VDC, 200mA
Operating temperature (humidity) range	0 to 40°C (20 to 80%RH, non condensing)
Storage temperature (humidity) range	-10 to 50°C (20 to 80%RH, non condensing)
External dimensions	96 (W) × 48 (H) × 84.6 (D) mm
Option	RS-link connecting cable 0.5m: No. 02ADD950 *1 RS-link connecting cable 1m: No. 936937 *1 RS-link connecting cable 2m: No. 965014 *1 Terminal board connecting cable: No. 02ADD930 *2 AC adapter: No. 02ADN460/AC cord: No. 02ZAA000

*1: Required for connecting with an EV-16A.

*2: Connected to the terminal board when using the AC adapter.



External dimensions

Unit: mm

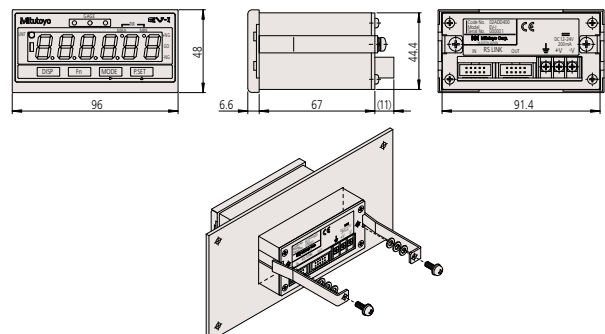

I/O connector

No. **02ADB440** (with cover)

Receptacle to fit the I/O output plug of the **EV-16A**



Terminal board connecting cable

No. **02ADD930**



This AC adapter is used to connect to the power supply terminal of the **EV-16A** and display unit **D-EV**. This terminal board connecting cable is used to supply power to the **EV-16A** and display unit **D-EV**.

AC adapter

No. **02ADN460**

AC cord

No. **02ZAA010**

RS-link connecting cable

Order No.	Cable length
02ADD950	0.5m
936937	1m
965014	2m

This cable is used to connect the EH/EV counters and the RS unit.



RS Link Function

This function allows up to 10 **EV-16A** units to connect with each other, thus enabling multipoint measurement of up to 60 channels. The dedicated RS-link connecting cable No. **02ADD950** (0.5m), No. **936937** (1m) or No. **965014** (2m) is used for connection. (The total length of RS-link connecting cables is limited to a maximum of 10m over the entire system.)

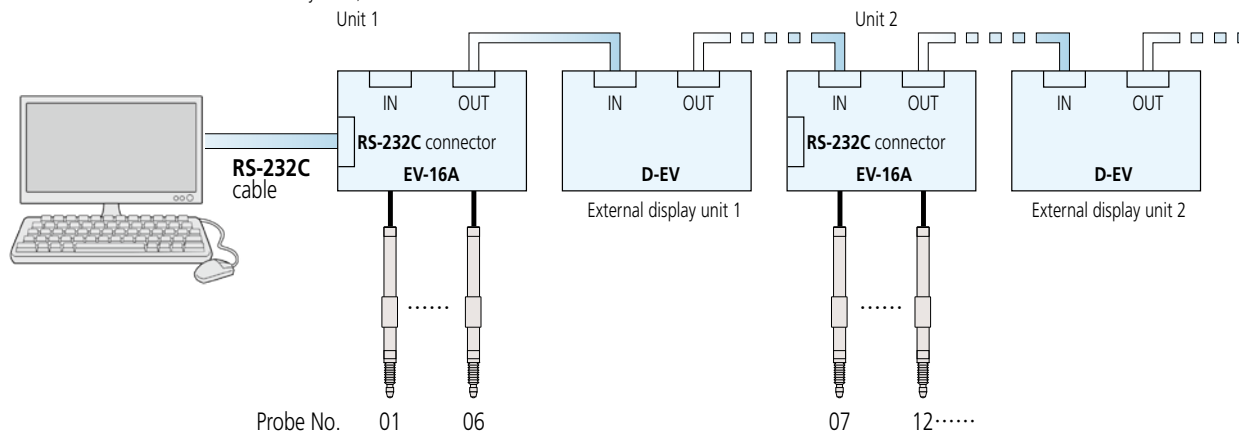

RS-232C Communication Function

This function enables remote operation of measurement data entry and various settings such as zero-setting for the **EV-16A**.

Command format	Corresponding output	Operation details
GA**CRLF	G**,+01234.567CRLF	Output of [display value] via RS-232C
CN**CRLF	CH**CRLF	Switching display to [current value]
CX**CRLF	CH**CRLF	Switching display to [maximum value]
CM**CRLF	CH**CRLF	Switching display to [minimum value]
CW**CRLF	CH**CRLF	Switching display to [TIR (runout)]
CR**CRLF	CH**CRLF	Zero-setting
CL**CRLF	CH**CRLF	Clear of peak value
CP**_01234567CRLF	CH**CRLF	Input of preset value and execution of presetting
CD**_01234567CRLF	CH**CRLF	Input of lower tolerance limit
CG**_01234567CRLF	CH**CRLF	Input of upper tolerance limit
CS**CRLF	CH**CRLF	Cancel of error
CK**CRLF	CH**,\$CRLF (\$0 or 1)	Verification of HOLD status
CT**CRLF	CH**Y,+01234.567CRLF	Output of [calculation value] via RS-232C

Note 1: "*" indicates a probe channel number between 01 and 60 (all channels for 00).

Note 2: "#" indicates a type of data [N: current value, X: maximum value, M: minimum value, W: TIR (runout)].

Note 3: CRLF means carriage return (CR) and line feed (LF).

Note 4: Input presetting and tolerance setting values with a sign and 8-digit numerical value without placing a decimal point.

Note 5: Set a tolerance limit in order of command CD and CG.

Note 6: Upon data request of a calculation value, all channels cannot be specified.

Note 7: The RS communication function is temporarily stopped during key operation (for setting of a parameter, preset value or tolerance limit) and then executes command and data output when the count enabled status is restored.

Note 8: Execute cancellation of the count standby status with CS00CRLF (all-channel designation).

RS-232C Specifications

(1) Suitable plug: D-sub 9-pin (female), inch screw

(2) Pin assignment

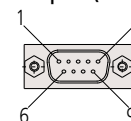

Receptacle
D-sub 9-pin (male),
inch screw specification

Pin No.	Signal name	IN/OUT	Description (use)
2	RXD	IN	Receive data
3	TXD	OUT	Transmit data
4	DTR	OUT	Data terminal ready
5	GND	—	Ground
6	DSR	IN	Data set ready
7	RTS	OUT	Request to send
8	CTS	IN	Clear to send
1, 9	N.C.	—	No connection

(3) Communication specification (compatible with EIA RS-232C)

Home position	DTE (terminal definition), A crossover cable must be used.
Communication method	Half-duplex, nonprocedural
Baud rate	4800 9600 19200bps
	Start bit: 1
	Data bit: 7 & 8, ASCII, upper case
Bit configuration	Parity bit: none, even number, odd number
	Stop bit: 2
Communication condition setting	Setting with a parameter

(3) I/O circuitry

(1) Output circuitry: Output of tolerance judgment, NOM (nominal), segment, etc.
The transistor turns "ON" at input 'low'. (Open Collector output).

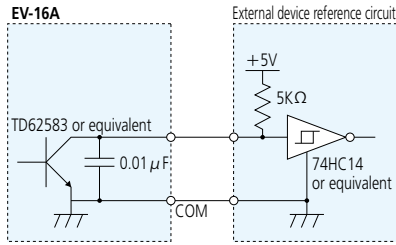

Withstand voltage: Max. 24V
Output current: Max. 20mA
Output saturation voltage: Max. 0.7V

(2) Input circuitry: Input of P.SET, HOLD, SET, etc.
An input is effective at 'low'.

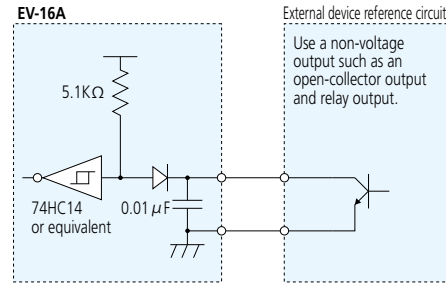

Input current: Max. 1mA
Output saturation voltage: Max. 0.7V

(4) Timing chart

(1) Power-ON characteristic

In the RS LINK connection mode, the time when the **EV-16A** is initially turned on becomes the reference.

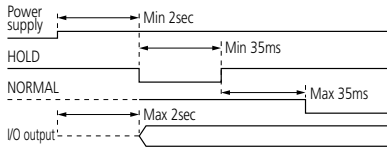

(2) Tolerance judgment result output time

Each CEL output is not concurrent.

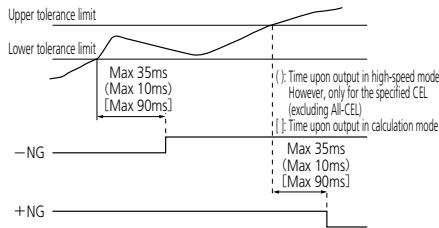

(3) Data output

Data output is provided with two methods, command mode and interval mode which can be set with each I/O output mode parameter.

1) Command mode (All-CEL output)

This mode allows data output of All-CEL (specified with SET1 to SET3) under the concurrent control of HOLD and READY.

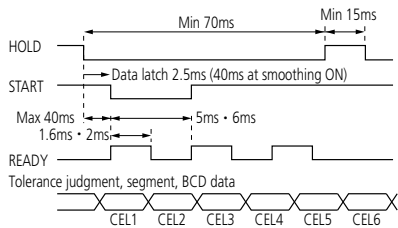

Note: UNIT LED (on D-EV) blinks during HOLD input.

2) Command mode (Discrete CEL output)

This mode allows data output of discrete CEL (specified with one of SET1 to SET3) under the concurrent control of HOLD and READY.

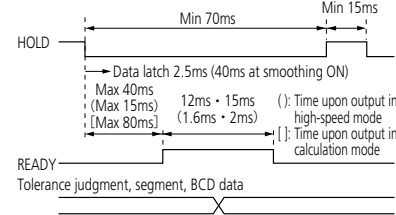

Note: If using the high-speed mode or all-CEL output, use a device with an input response time of 1ms or less.

3) Interval mode (All-CEL output)

This mode allows continuous data output of All-CEL (specified with SET1 to SET3) at the internal timing of the **EV-16A**.

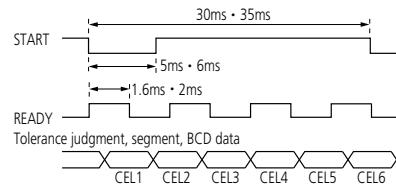

Note: If using the high-speed mode or all-CEL output, use a device with an input response time of 1ms or less.

4) Interval mode (Discrete CEL output)

This mode allows continuous data output of discrete CEL (specified with one of SET1 to SET3) at the internal timing of the **EV-16A**.

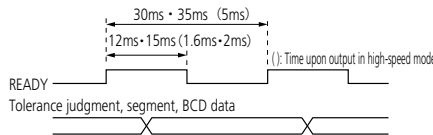

(4) External presetting

Assume that the current value of a CEL specified from among SET1 to SET3 is equal to a preset value.

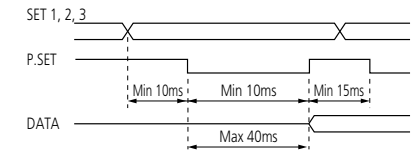

When presetting is executed, the peak value is cleared.
(Max. = Min. = Current value, TIR = 0)

(5) Output CEL designation/calculation method selection

Designate a CEL specified from among SET1 to SET3 as a data output CEL.

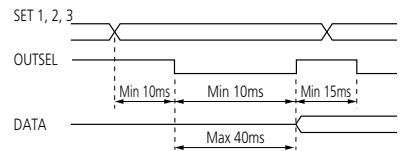

Input of SET1 from SET3 at the time of segment output SET1 to SET3 normally operate as range specification data. (This data operates as designation of an output CEL upon input of OUTCEL.)

Data operation differs depending on the setting from among I/O function selection parameters.

- NORMAL, high-speed mode: Output CEL designation
- Calculation mode: Calculation method selection

(6) Peak clear

This function clears a peak value.
(Max. = Min. = Current value, TIR = 0)

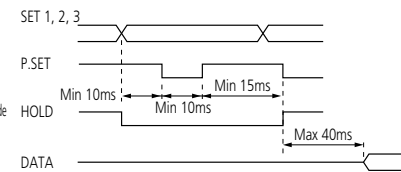

Note: Peak clear is executed only in the Peak mode.
(Presetting is executed when the current value is selected.)

SENSORPAK (Data Import Software for EV Counter)



Measurement screen



Meter screen

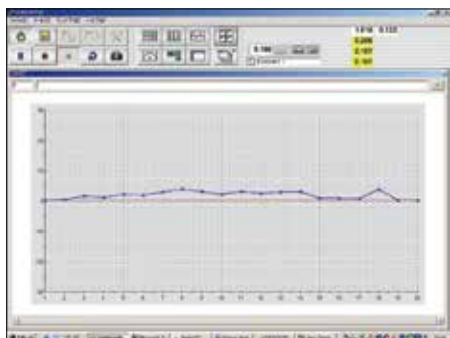

Chart screen

- This software imports measurement data from a 6-channel input type EV-16A to a PC.
- Measurement points can be processed up to 60 channels.
- Arithmetic operation and maximum width calculation from measurement data are also enabled.
- Measurement data can be transferred to MS-Excel.
- Analog display with aids such as bar-graph meters can be displayed in real time.

Real-time Display of Measurement Data

A vertical pin is measured from 3 directions to determine the reference position and pin inclination.

A real-time display of measured data also allows installation of a part while positioning it.

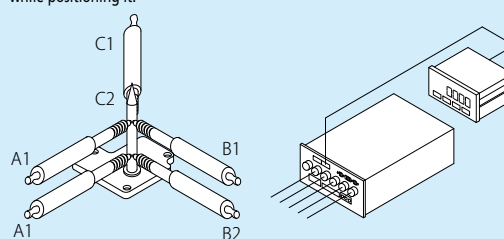

Monitoring the Feedback State of Measurement Data

The feedback state of press working data can be monitored. This allows verification of time series data.

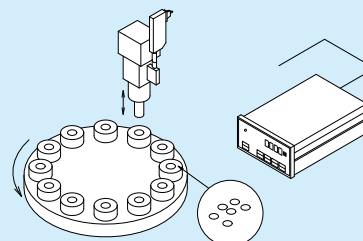

SPECIFICATIONS

Order No.	02NGB073 (Software plus I/O cable)
Display function	Display type: Counter, bar graph, meter, chart (capable of simultaneous display) Tolerance judgment result: Color display (green/red) Connectable gages: max. 60 gages
Calculation functions	Calculation items: Sum, difference, total, average, maximum, minimum, range (maximum–minimum), calculation with a constant Connectable gages: Max. 30 calculation functions (between two gages)
Total tolerance judgment	Go/no go judgment (by specifying gages to be used for total tolerance judgment) Go/no go signal output with optional I/O cable
Input function	Trigger function: by means of key, timer or external TRG (with optional I/O cable) Data input frequency: Max. 9999 times (with 60 gages connected) to 60000 times (with 6 gages connected)
Output function	Direct output to EXCEL spreadsheet, CSV file output (compatible with MeasurLink)
Connectable items	Various Mitutoyo counters (those compatible with RS Link)
System Environments	Recommendation: PC/AT compatible machine, CPU: Clock 2GHz or more, Memory: 2GB or more Disk: 2GB or more OS: Windows 7/8.1 (32bit/64bit)

Currently supported languages: English, German, French, Spanish
User's manual: English

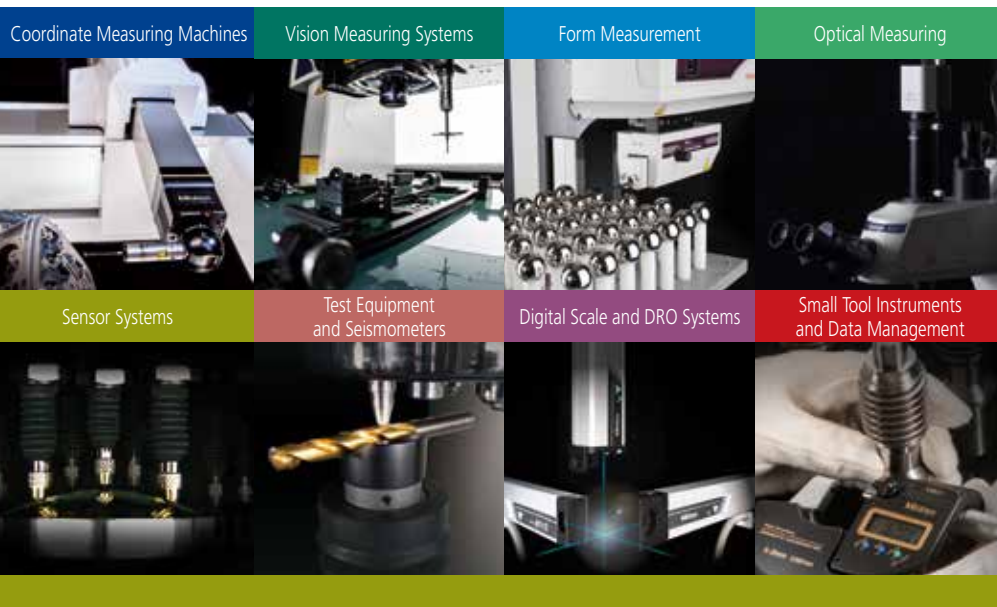

Whatever your challenges are, Mitutoyo supports you from start to finish.

Mitutoyo is not only a manufacturer of top quality measuring products but one that also offers qualified support for the lifetime of the equipment, backed up by comprehensive services that ensure your staff can make the very best use of the investment.

Apart from the basics of calibration and repair, Mitutoyo offers product and metrology training, as well as IT support for the sophisticated software used in modern measuring technology. We can also design, build, test and deliver bespoke measuring solutions and even, if deemed cost-effective, take your critical measurement challenges in-house on a sub-contract basis.



Find additional product literature and our product catalog

www.mitutoyo.com

Note: All information regarding our products, and in particular the illustrations, drawings, dimensional and performance data contained in this printed matter as well as other technical data are to be regarded as approximate average values. We therefore reserve the right to make changes to the corresponding designs. The stated standards, similar technical regulations, descriptions and illustrations of the products were valid at the time of printing. In addition, the latest applicable version of our General Trading Conditions will apply. Only quotations submitted by ourselves may be regarded as definitive. Specifications are subject to change without notice.

Mitutoyo products are subject to US Export Administration Regulations (EAR). Re-export or relocation of our products may require prior approval by an appropriate governing authority.

Trademarks and Registrations

Designations used by companies to distinguish their products are often claimed as trademarks. In all instances where Mitutoyo America Corporation is aware of a claim, the product names appear in initial capital or all capital letters. The appropriate companies should be contacted for more complete trademark and registration information.



Mitutoyo America Corporation

www.mitutoyo.com

One Number to Serve You Better

1-888-MITUTOYO (1-888-648-8869)

M³ Solution Centers:

- Aurora, Illinois (Headquarters)
- Boston, Massachusetts
- Huntersville, North Carolina
- Mason, Ohio
- Plymouth, Michigan
- City of Industry, California
- Birmingham, Alabama
- Renton, Washington
- Houston, Texas