

SERIES 77

LIGHTWEIGHT ADJUSTABLE SHALLOW DIAMETER GAGES

For use at machine or inspection area for checking inside and outside diameters, shallow bores, counter bores, pitch diameters of gears, and many other dimensions.

FEATURES

- Fast & dependable 2 point measurement directly across diameter.
- Frictionless Reed Transfer Mechanism provides precise repeatability.
- 0 to 1" adjustable gaging depth.
- Hardened A-2 steel gage rest surface.
- Fast acting Rack & Pinion find adjustment for rapid setting.
- Positive mechanism instantly changes gaging direction & preloads indicator. No loose parts.
- May be set with gage blocks, ring gage or qualified part.
- Several contact types available from stock.
- Gaging contacts may be rotated as they wear, greatly extending their useful life.

SPECIFIC TYPES



78M



77M



70M

SPECIFICATIONS FOR GAGES

Mod. No.	Indicator	Indicator Travel	Inside Range	Outside Range	Adj. Gaging Depth	Length	Approx. Wgt.
70 M	.0001"	.050"	7/16"-3 1/4"	1/32"-3"	0"-1"	4 1/2"	19 oz.
71 M	.0005"	.050"	7/16"-3 1/4"	1/32"-3"	0"-1"	4 1/2"	19 oz.
75 M	.0005"	.050"	7/16"-5 1/2"	1/32"-5 3/16"	0"-1"	7 1/2"	25 oz.
76 M	.0005"	.050"	7/16"-9 5/16"	1/32"-9"	0"-1"	11 3/8"	30 oz.
77 M	.0001"	.050"	7/16"-5 3/16"	1/32"-5 3/16"	0"-1"	7 1/2"	25 oz.
78 M	.0001"	.050"	7/16"-9 5/16"	1/32"-9"	0"-1"	11 3/8"	30 oz.

70M & 71M gages are supplied with an AGD group 1 dial indicator with rev counter and 1 set no. 79-100 contact points.

75M through 78M gages are supplied with an AGD group 2 dial indicator with rev counter and 1 set no. 79-100 contact points. Metric indicators available for all models.

Ph 866-945-5742 / info@willrich.com

M U E L L E R G A G E S

SPECIFICATIONS FOR CONTACT POINTS

Number	Gaging Adj. Depth	Material	Diameter
79-100	0" - 1/2"	Hardened Steel	3/16"
79-200	1/2" - 1"	Hardened Steel	3/16"
79-100C	0" - 1/2"	Carbide Ball	3/16"
79-200C	1/2" - 1"	Carbide Ball	3/16"
79-1-100C	0" - 1/2"	Half Carbide Ball	3/16"
79-1-200C	1/2" - 1"	Half Carbide Ball	3/16"
79-500	0" - 1/2"	} .050" thick x .500" Dia . Disc Contact	
79-600	1/2" - 1"		
79-1-SP	0" - 1/2"	} Special Carbide Ball Contact Specify Ball Dia. Required	
79-2-SP	1/2" - 1"		

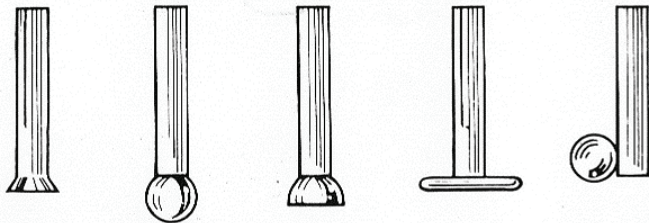

79-100 79-100C 79-1-100C 79-500 79-1-SP
 79-200 79-200C 79-1-200C 79-600 79-2-SP

Hardwood Storage Cases
 No. 72 for models 70M & 71M
 No. 80 for models 75M & 77M
 No. 81 for models 76M & 78M

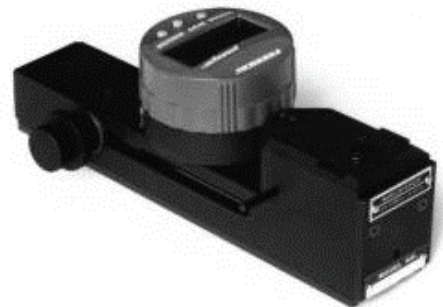
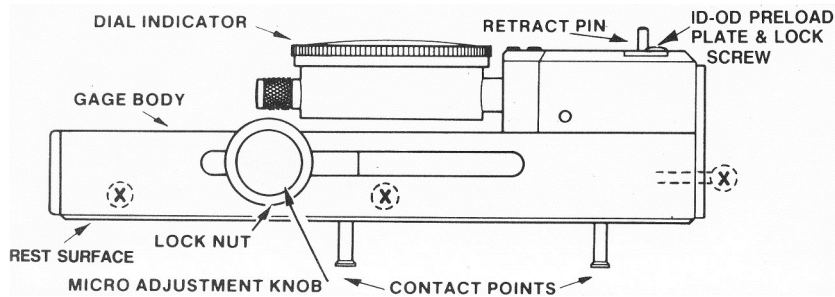

**Model 77M with Analog/
 Digital Indicator**

MORE INFORMATION



SERIES 88

ADJUSTABLE DIAMETER & GROOVE GAGE

FEATURES



- Precise depth setting makes groove diameter inspection easier when the part face can be used as a datum surface.
- Hardened & precision ground A-2 steel rest surface.
- Full 1" travel or retraction for checking deep grooves.
- Fine adjustment mechanism for rapid setting.
- Indicator can be rotated 360 degrees for easy viewing.
- Contact points adjustable to 2 1/2" depth.
- Optional stand available for use as a bench gage.

Model 88

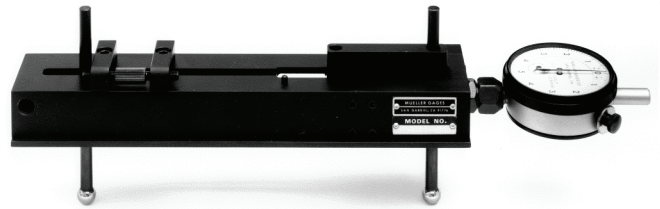

Contact Points

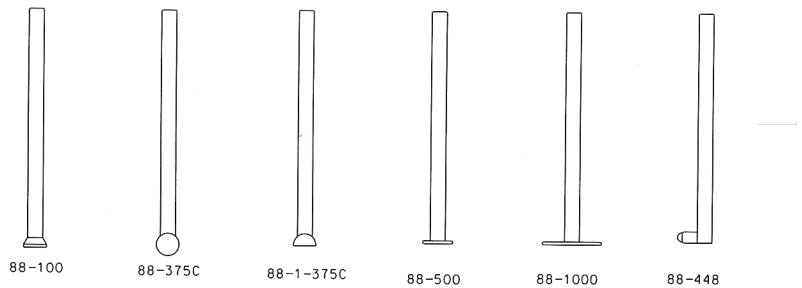

Model 88 shown with 88-10 bench stand, 88-1000 disc contacts and digital indicator.

88-1 Storage Case



Gage supplied with 88-375C contacts. Other contacts may be substituted at additional cost.

Contact Point	Depth Range	I.D. Range	O.D. Range	Description
88-100	.080 - 2.5	.760 - 7.97	0 - 7.22	HSS
88-375C	.050 - 2.5	.760 - 7.97	0 - 7.22	3/8" Grade 25 Carbide Ball
88-1-375C	.050 - 2.5	.760 - 7.97	0 - 7.22	3/8" Grade 25 1/2 Carbide Ball
88-500	.025 - 2.5	1.02 - 8.10	0 - 7.10	.050 x .500 Hard Chromed Disc
88-1000	.025 - 2.5	2.02 - 8.60	0 - 6.60	.050 x 1.00 Hard Chromed Disc
88-448	.100 - 2.5	1.10 - 8.30	0 - 6.90	3/16 Ø Ruby or 1/4 Ø Carbide with 4-48 Thread

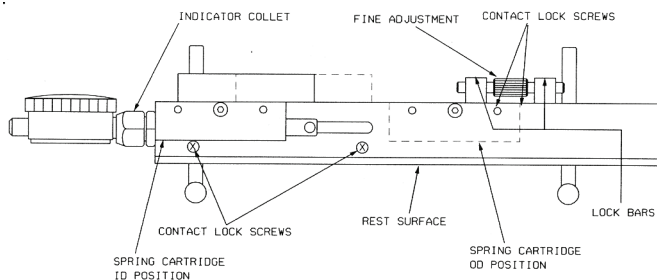

Gage Weight:
38 oz.

Overall length with indicator:
12.75 in.

88-50 set – includes 88 gage, .0001 indicator, 88-1 case, 88-375C, 88-1000 contacts & 88-10 bench stand.

866-945-5742 /info@willrich.com

SERIES 179

PARALLEL MOVEMENT GROOVE DIAMETER GAGE

**FAST, ACCURATE CHECKING OF
INTERNAL GROOVES & RECESSES.**



**Model 179 with 180-0
Measuring Tips**

**Model 179 with optional
Analog/Digital Indicator,
179-40 Reference Rail and
180-15 Measuring Tips**



179-50 Gage Set



- Precision linear ball bushing movement.
- Full 1" travel (retraction) for deep grooves and recesses up to .500 per side.
- Lightweight magnesium body.
- Measuring tips remain parallel throughout entire travel.
- Large standard diameter range from .290 to 7.900" – larger range available with optional lower reference bar.
- Complete range of standard 2 point and 3 point contact measuring tips available from stock with inreach up to 4 1/2". Tips are hardened, precision ground & hard chrome plated for long wear life.
- Special & modified standard measuring tips available for special applications.
- Weight of gage rests on stationary lower measuring tip – reduces possibility of operator error.
- Gage quickly & easily set with 1/4" travel fine adjustment.
- Set with micrometer, gage blocks, ring gage or qualified part.
- May be used with our 1400 series carbide ball measuring tips to check pitch diameters of gears & splines. Also internal ball races and dovetails.
- Supplied with AGD Group I .0005" dial indicator with rev. counter & 1/8" travel. .0001" & metric indicators available.
- Gage may be used with any AGD Group II style (2 1/4" dia.) Electronic digital indicator with SPC output.
- Fitted storage case available for gage and accessories.

FEATURES



866-945-5742 /info@willrich.com

M U E L L E R G A G E S



- **Model 179 gage** - consists of gage body with AGD Group I .0005" & metric dial indicators available
- **Measuring tips ordered separately** . See chart for tip selection.
- **179 - 50 gage set** includes 179 gage with .0005" dial indicator, 1 set 1503 measuring tips & choice of 1 set 180 - 0 or 180 - 5 or 180 - 10 measuring tips & 182 case. Other tips may be substituted.

Optional Accessories

- **182 storage case**
- **179 - 40 long lower reference bar** (will not fit standard 182 storage case.)
- **179 - 65 adjustable tip stops**.

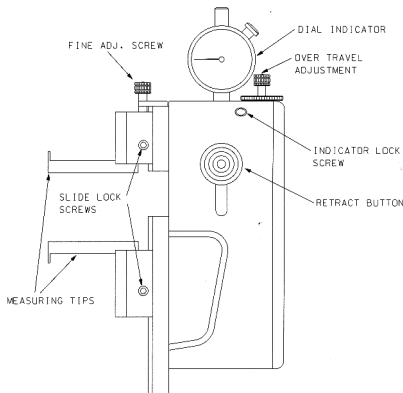

STANDARD MEASURING TIPS

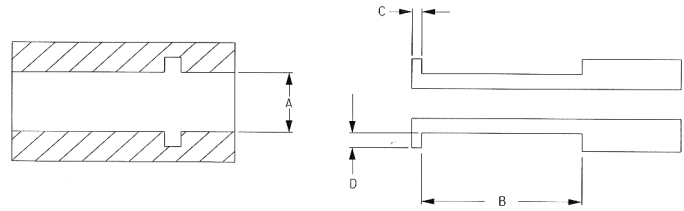

STANDARD MEASURING TIPS					
Tip Number		A	B	C	D
Upper	Lower	Min - Max Bore. Dia. Range	Length of Meas. Tip	Width of Meas. Tip	Depth of Meas. Tip
1503	1503	.290 - 4.125	1 1/4	.050	.110
1504	1504	.730 - 7.187	1 1/4	.040	.210
1504	*1504 - 3	.730 - 7.187	1 1/4	.040	.210
180-0	180 - 0	1.050 - 7.375	1 1/2	.050	.210
180-5	180 - 5	1.050 - 7.375	2 1/2	.050	.210
180-10	180 - 10	1.150 - 7.500	3 1/2	.050	.250
180-10	*180 - 30	1.150 - 7.500	3 1/2	.050	.250
180 - 15	180 - 15	1.700 - 7.900	4 1/2	.080	.500

* 3 point contact measuring tips require cylindrical master

The following measuring tips are available with special width ('C' dimensions) at no extra charge when specified on purchase order.

Measuring Tip No.	Standard Width	Special Width
» 1503	» .050	» .022
» 1504	» .040	» .020

Approximate weight of gage with measuring tips is 28 oz.

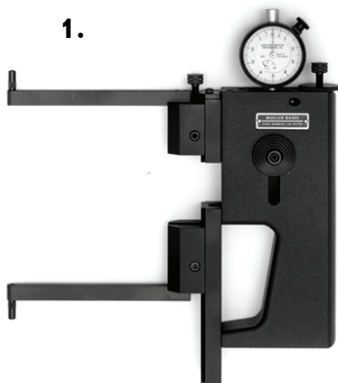

1. 179 with 1400-4/4-48 threaded stems. Accepts standard AGD indicator contacts.

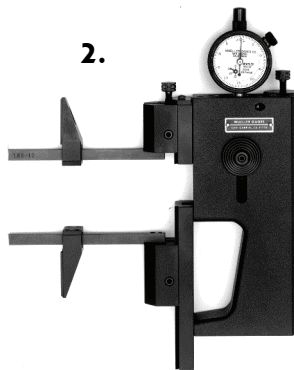

2. Model 179 with 180-10 measuring tips & 179-65 adjustable tip stops. May be used with all 180 series, 1504 & 1400 tips. Stops are positioned so they touch face of part when tip blade contacts groove. Eliminates need to rock gage to obtain minimum reading.

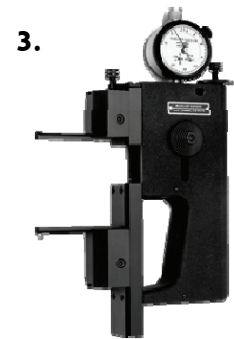

3. Model 179 with 1400 carbide ball tips to check internal diameter of parts with spherical radius. Also checks pitch diameter of splines and gears. See 1400 brochure.

866-945-5742 /info@willrich.com

SERIES 560

LIGHTWEIGHT ADJUSTABLE SHALLOW DIAMETER GAGES

For quick & easy checking of shallow inside & outside diameters, center distances of holes, pitch diameters of gears, & related dimensions.

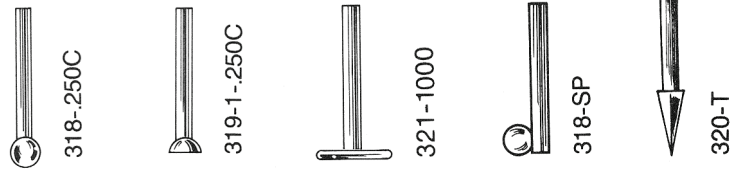

CONTACT POINTS	
Number	Description
318-.250C	.250" dia. Carbide Contact Point
319-1-.250C	.250" dia. Carbide Half Ball Contact Point
321-1000	.050" Thick x 1.000" dia. Disc Contact Point
318-SP	Special Carbide Ball Contact (Specify Ball Diameter Required)
320-T	Taper contact for center distance of holes from 3/32 to 3/8 dia.
318-100	.250" dia. HSS Contact Point

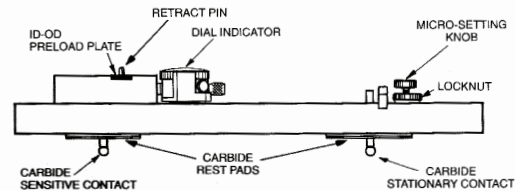

FEATURES



- Checks diameters by comparing part dimensions to gage blocks. Actual part dimension shown on dial indicator.
- Gage may be used with and AGD Group II style (2 1/4" dia.) Electronic digital indicator with SPC output.
- Gage rests on face of part for fast and dependable 2 point measurement directly across diameter.
- Lightweight – Alloy Steel Airframe tubing gage body.
- 4 1/2" to 60" Diameter Range – 6 Models – Larger sizes available
- Frictionless Reed Transfer Mechanism provides precise repeatability
- Fast acting Rack and Pinion fine adjustment for rapid setting.
- Positive mechanism instantly changes gaging direction and preloads indicator.
- Easily set with gage blocks or qualified part.
- 0 to 1" adjustable gaging depth.
- Carbide gaging contacts.
- Carbide gage rest surface.
- Gaging contacts may be rotated as they wear, greatly extending their useful life.
- Hardwood storage cases available for all models.

866-945-5742 /info@willrich.com

M U E L L E R G A G E S

SPECIFICATIONS FOR #560 GAGES			
Mod. No.	I.D. - O.D. Range	Length	Approx. Wgt.
560	4 1/2" to 12"	18"	2 lb.
561	12" to 18"	24"	2 lb. 2 oz.
562	18" to 24"	30"	2 lb. 4 oz.
563	24" to 36"	42"	3 lb.
564	36" to 48"	54"	4 lb.
565	48" to 60"	66"	4 lb. 8 oz.

- Supplied with AGD Group 1 .0005" dial indicator with revolution counter. Gage travel is .040".
- .0001", .01mm, or .002mm dial indicators available.
- Fully adjustable gaging depth from 0 to 1".
- With #319-1-250C half ball carbide contacts diameters may be checked very close to the face of a counter bore.
- Fitted hardwood storage cases available for all models.
- Gages supplied with 318-.250C carbide ball contacts and AGD group 1 .0005" dial indicator unless otherwise requested.

590 SERIES INSIDE & OUTSIDE: DIAMETER REFERENCE MASTERS

The 590 Series Reference Masters are offered in 6 sizes to accommodate our No. 560 series lightweight Adjustable Shallow Diameter Gages. They feature a depth range from 0 to 1" and a 1/2" rack & pinion fine adjustment for fast and easy setting. The range blocks are hardened and precision ground and the Reference Master body is made from precision ground and stress relieved alloy steel tubing. This reference master may be used with both the No. 321-1000 1" diameter and 318-250C, 319-1-350C 1/4" diameter contact points supplied for the No. 560 series.

Reference masters are set by the gage master is has been set to the required dimension by gage blocks etc. The reference master can then be placed in the production area to periodically verify the gage setting.

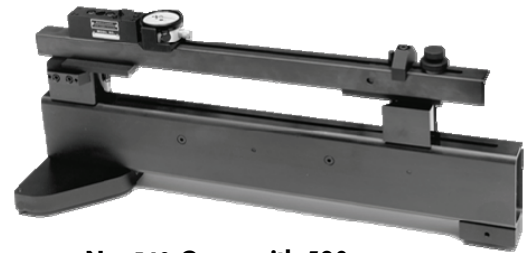

No. 560 Gage with 590 Reference Master

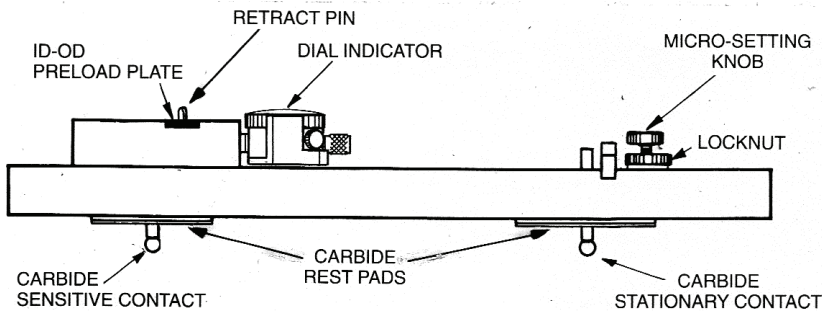

NO. 590 SERIES REFERENCE MASTERS		
Model No.	Inside & Outside Diameter Range	Depth Range
590	4 1/2" - 12"	0 - 1"
591	12" - 18"	0 - 1"
592	18" - 24"	0 - 1"
593	24" - 36"	0 - 1"
594	36" - 48"	0 - 1"
595	48" - 60"	0 - 1"

HARDWOOD STORAGE CASES		
560-1	For Model	560
561-1	For Model	561
562-1	For Model	562
563-1	For Model	563
564-1	For Model	564
565-1	For Model	565



Model 560 with No. 560-1 Hardwood Storage Case

3866-945-5742 /info@willrich.com

M U E L L E R G A G E S

SERIES 700

DOUBLE ACTION GROOVE LOCATION & DEPTH GAGES

Available in two styles and two sizes. Models 700 and 707 feature rectangular base for use as fully adjustable depth gage. Additional uses include checking groove location from face of part and groove width at the same time. Models 709 and 711 are supplied with extensions featuring an adjustable locating disc for checking the distance from the face of a counter bore to a groove or from one groove to another groove. Groove widths may also be checked with one simple motion that reverses the gaging of the footed rod.

- Adjustable depth range from 0 to 6" or 0 to 12" depending on the model.
- Supplied with .0005" dial indicator with revolution counter. .0001", .01mm & .002mm dial indicators available.
- May be set with gage blocks or other suitable means.
- No special skill required to set or use gage.
- Longer measuring rods and special measuring feet available.
- Instant reverse capability for changing gaging direction of footed measuring rod.
- Supplied in protective storage case.

FEATURES



SPECIFIC TYPES



700



707
Shown with Optional
Digital Indicator



709



711

866-945-5742 /info@willrich.com

M U E L L E R G A G E S



700 GROOVE LOCATION & DEPTH GAGE

Minimum bore diameter with footed rod $5/16"$. Thickness of measuring foot $.050"$. Measuring rod diameter $1/8"$. Total inreach - adjustable 0 - $6"$. - $5/8" \times 4"$ hardened and ground measuring base. $1/8"$ measuring rod travel. Supplied with AGD Group 1 $.0005"$ dial indicator with $1/8"$ travel & revolution counter, one footed rod, one plain rod, & fitted storage case.

707 GROOVE LOCATION & DEPTH GAGE

Minimum bore diameter with footed rod $11/32"$. Thickness of measuring foot $.050"$. Measuring rod diameter $5/32"$. Total inreach adjustable 0 - $12"$. $3/4" \times 4-3/4"$ hardened & ground measuring base. $1/2"$ measuring rod travel. Supplied with AGD Group 2 $.0005"$ dial indicator with $1/2"$ travel & revolution counter, one footed rod, one plain rod & fitted storage case.

709 GROOVE LOCATION GAGE

Minimum bore diameter $1/2"$. Total inreach - Adjustable 0 - $6"$. $1/8"$ measuring rod travel. Thickness of measuring foot & locating disc $.050"$. Measuring rod diameter $1/8"$. Supplied with AGD Group 1 $.0005"$ dial indicator with $1/8"$ travel & revolution counter, one footed rod and fitted storage case.

711 GROOVE LOCATION GAGE

Minimum bore diameter $.750"$. Total inreach - Adjustable 0- $12"$. $1/2"$ measuring rod travel. Thickness of measuring foot & locating disc $.050"$. Measuring rod diameter $5/32"$. - Supplied with AGD Group 2 $.0005"$ dial indicator with $1/2"$ travel & revolution counter, one footed rod & fitted storage case.



ACCESSORIES

$7/8"$ diameter measuring base for use in place of anvil in confined areas.

For model 700-

Specify #701 measuring base

For model 707-

Specify #708 measuring base.



All 700 series models are supplied with fitted storage cases.

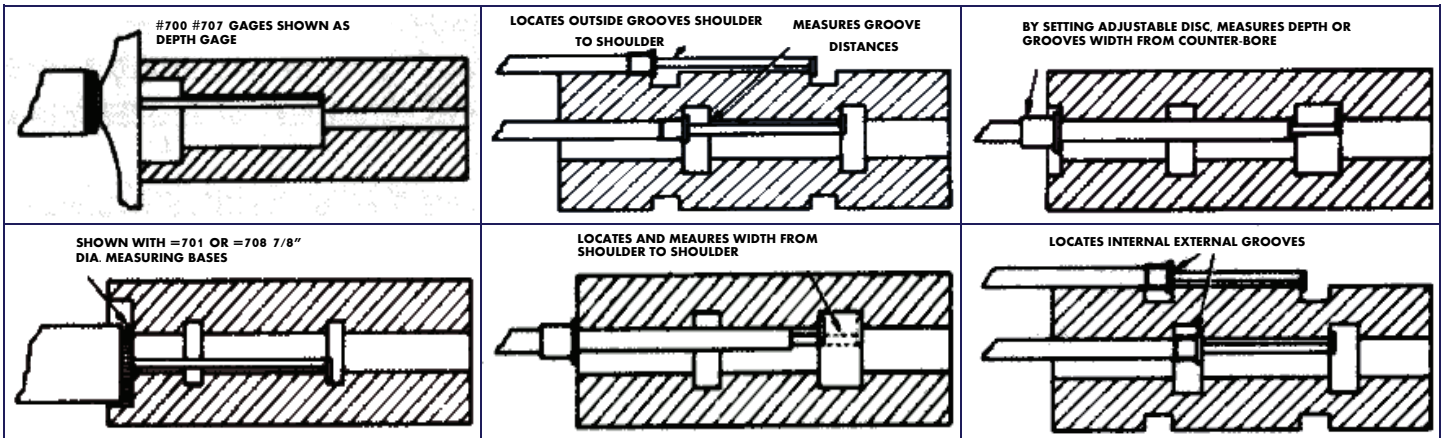

866-945-5742 /info@willrich.com

SERIES 900

GROOVE DIAMETER GAGES

For small diameter grooves and recesses from 5/32" to 1 1/8". Standard inreach 1" to 4" depending on the model.



Model 952-2



Model 903-2



Model 952-2 with
Analog/Digital

- **900 SERIES**
Models 901-2, 902-2, and 903-2 complete set 905-2. .154 to .615 diameter range with 3 measuring tips. Inreach from 1" to 1 7/8 " depending on tip.
- **950 SERIES**
Models 951-2, 952-2, 953-2, complete set 957-2. .495 to 1.1288 diameter range with 3 measuring tips. Inreach from 2 1/2" to 4" depending on tip.
- Models 951-2, 952-2, 953-2, complete set 957-2. .495 to 1.128 diameter range with 3 measuring tips. Inreach from 2 1/2" to 4" depending on tip.
- Supplied with .0005" indicator. .0001" and metric dial indicators available.
- Measuring tips are hardened and hard chrome plated for long wear.
- Gages may be set with micrometers, gage blocks, ring gages, etc. Three point contact gages set with cylindrical master only.
- Storage cases available for all models. Supplied with 905-2 & 957-2 sets.
- 950 series gage may be used with any ASD Group II style (2 1/4" dia.) electronic digital indicator with SPC output.

FEATURES





900 series gages are supplied complete with gage body, measuring tip and .0005" dial indicator. Models 905-2 and 957-2 are complete sets with gage body, dial indicator, 3 measuring tips and protective storage case.

These gages are available in 2 sizes. Models 901-2, 902-2, & 903-2 are the smaller versions offering a .154 to .615 diameter range with the 3 available tips. This size uses the AGD miniature dial indicator. The larger 951-2, 952-2, & 953-2 models use the AGD Group 1 dial indicator and offer a .495 - 1.128 diameter range with all 3 tips.

Please use the following chart to make your selection.

#900 SERIES GROOVE GAGES					
A		B	C	D	
Gage Model No.	Bore. Dia. Range Min - Max	Length of Meas. Tip	Width of Meas. Tip	Depth of Meas. Tip	Tip No.
901-2	.154 - .320	1.000	.040	.060	101-2
902-2	.245 - .440	1 7/8	.050	.065	102-2
903-2	.372 - .615	1 7/8	.060	.100	103-2
905-2	.154 - .615	Includes 101-2, 102-2, 103-2 Meas., Tips, & Storage Case			
Storage Case - No. 900-1					

#950 SERIES GROOVE GAGES					
A		B	C	D	
Gage Model No.	Bore. Dia. Range Min - Max	Length of Meas. Tip	Width of Meas. Tip	Depth of Meas. Tip	Tip No.
951-2	.495 - .740	2 1/2	.060	.160	151-2
952-2	.245 - .440	3 3/8	.070	.180	152-2
953-2	.372 - .615	4.000	.125	.240	153-2
957-2	.154 - .615	Includes 151-2, 152-2, 153-2 Meas., Tips, & Storage Case			
Storage Case - No. 950-1					

SPECIFICATIONS FOR 900 SERIES MEASURING TIPS

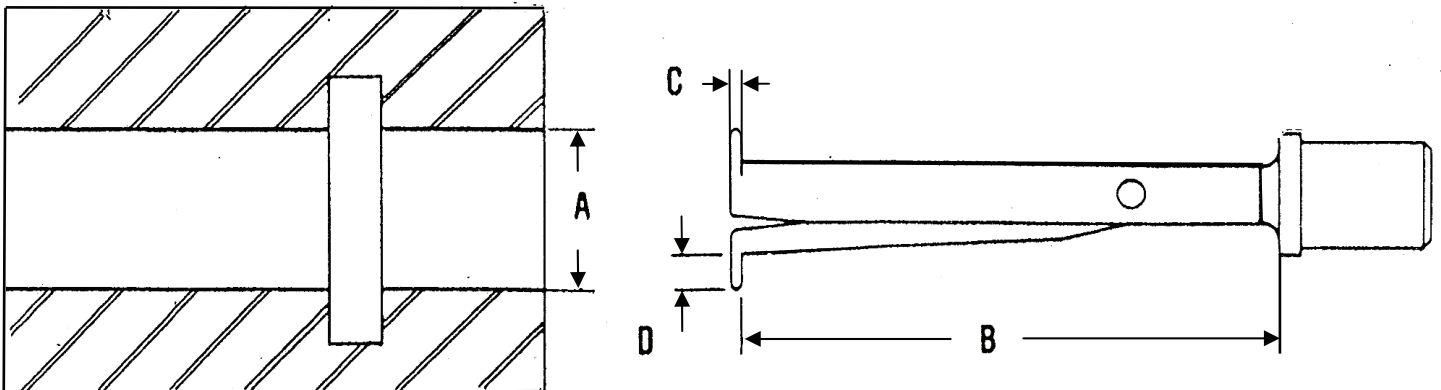

Please Note: Three point contact measuring tips are available at no additional cost. Substitute -3 for -2 following gage or tip model no. Example: 952-2 is 2 point & 952-3 is 3 point contact. Three point contact requires cylindrical setting master.

866-945-5742 /info@willrich.com

SERIES 1400

PITCH DIAMETER GAGES FOR GEARS, SPLINES, AS WELL AS SPHERICAL AND GROOVE DIAMETERS

Adjustable Gage with interchangeable measuring tips will check the following:

- Pitch diameter of splines and gears with even or uneven number of teeth, internal and external.
- Concentricity of internal gears-pitch diameter to OD.
- Concentricity of external gears-pitch diameter to ID.
- Spherical diameters of ball races, internal and external.
- Groove diameters, internal and external when used with our #1900 series measuring tips.

Carbide contact balls are available from .050" to .505" diameter in .0001" increments. Smaller and larger sizes available on special order at additional cost. Measuring tips also available with 4-48 thread to accept threaded ball segments. Standard inreach of #1400 tips is 1 1/4". Special 3 3/4" inreach tips available. Supplied with .0005" dial indicator only. Approximate weight of complete gage with tips is 22 oz. Range slide easily reversed for checking OD's. See #1900 Brochure for interchangeable tips for this unit to check groove diameters.

FEATURES



Model #1400-3 Pitch Diameter Gage with carbide ball measuring tips for internal dimensions.

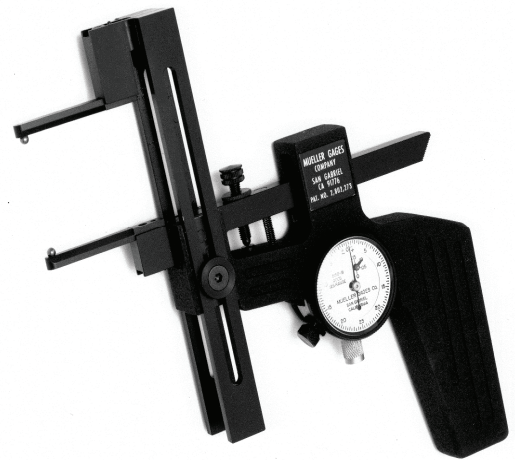

Model 1400 with slide and tips reversed to check external dimensions.

866-945-5742 /info@willrich.com

M U E L L E R G A G E S

#1400 Gage consists of gage body with AGD Group 1 .0005" dial indicator with rev counter. .0001" and metric dial indicators available. Measuring tips ordered separately.

#1400 Measuring tips are supplied in a set of 2. Please specify the diameter you require to the nearest .0001".

#1400-35 gage includes #1400 gage body with .0005" dial indicator and set #1400 carbide ball measuring tips. .0001" and metric indicators available.

GAGE RANGE - INSIDE DIAMETER			
Carbide Ball Diameter	Please specify exact diameter required to the nearest 0001".	From	To
.050" - .156" Ball		.750"	6.775"
.156" - .250" Ball		.812"	6.875"
.250" - .300" Ball		.937"	6.975"
.300" - .350" Ball		1.000"	7.075"
.350" - .400" Ball		1.125"	7.175"
.400" - .450" Ball		1.250"	7.275"
.450" - .505" Ball		1.312"	7.375"

GAGE RANGE - OUTSIDE DIAMETER			
Carbide Ball Diameter	Please specify exact diameter required to the nearest 0001".	From	To
.050" - .156" Ball		0	4.650"
.156" - .250" Ball		0	4.500"
.250" - .300" Ball		0	4.400"
.300" - .350" Ball		0	4.300"
.350" - .400" Ball		0	4.200"
.400" - .450" Ball		0	4.100"
.450" - .505" Ball		0	4.000"

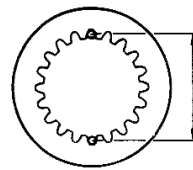

Pitch Diameter of Internal Gears

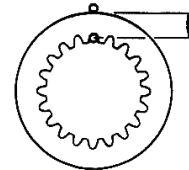

Concentricity Internal Gear P.D. & O.D.

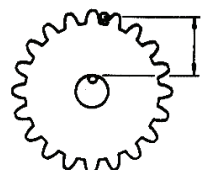

Concentricity External Gear P.D. & I.D.

#1801 Storage case available to hold gage and accessories.

866-945-5742 /info@willrich.com

SERIES 1550

ADJUSTABLE DIAMETER & GROOVE GAGE FRICTIONLESS BALL BUSHING MOVEMENT

High accuracy gage checks inside & outside diameters, groove diameters & related dimensions.

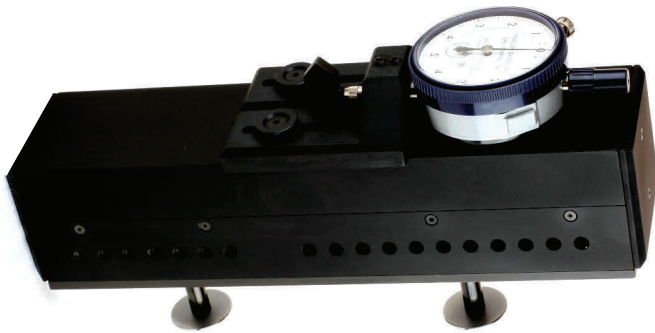

Model 1550

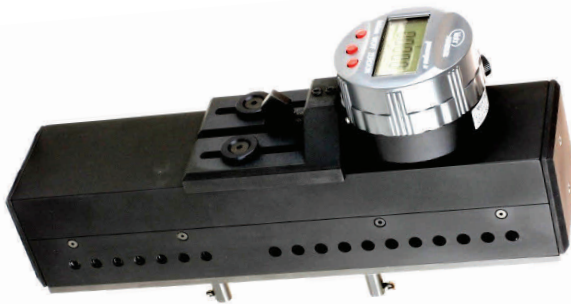

Model 1550 with Digital Indicator

Gage

Model 1550 Gage supplied with AGD Group 2 .0005" Dial Indicator with 1/2" travel & rev. counter. .0001" & metric indicators available. Gage supplied with 1 set No.1575-1 contact points. May be ordered with any style contacts.

Storage Case

No. 1550-1 for Model 1550. Gage Length 9-5/16". approx. weight 4#.

- Gage rests on face of part for fast & dependable 2 point measurement directly across diameter. Checks inside & outside diameters.
- Large 1" to 7-3/4" diameter range.
- Adjustable gaging depth from 1/16" to 3". Deeper depth range available.
- Linear ball bushing movement for precise repeatability. - 2 ground shafts with 8 precision ball bushings.
- Hardened steel rest surface.
- Full 1" travel (retraction) for checking deep grooves.
- Complete range of standard contact points available.
- Special 2 point & 3 point contacts made for custom applications.
- Fast & positive ID-OD reverse. No loose parts.
- Use with mechanical or electric indicator.
- Easily set with gage blocks, ring gage, or qualified part.

FEATURES

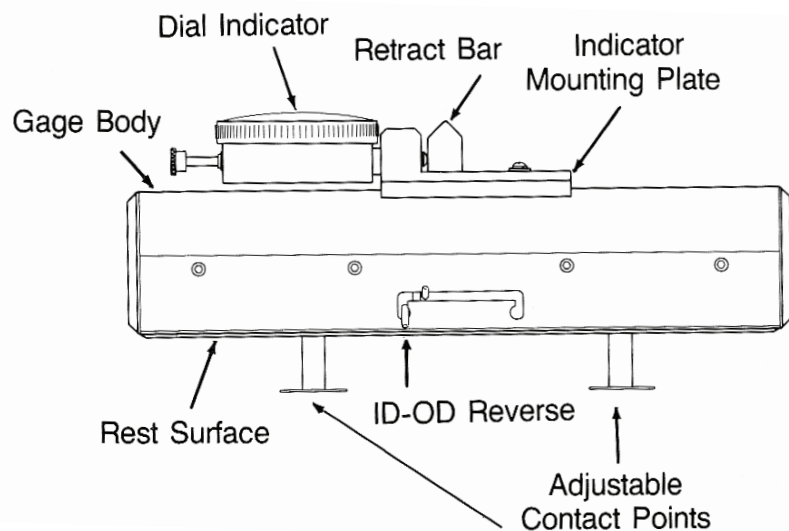

866-945-5742 /info@willrich.com

M U E L L E R G A G E S

Contact Points

▶ Select contact style & depth range required. Supplied in sets of 2 pcs. Stem diameter 5/16".

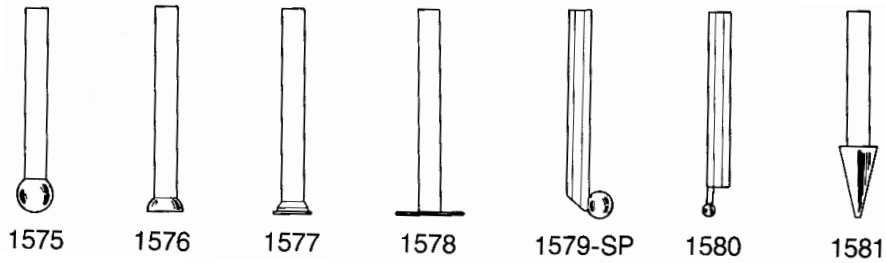

1/16"-1 Adj. Depth Range	1"-2" Adj. Depth Range	2"-3" Adj. Depth Range	Description
1575-1	1575-2	1575-3	1/2" Dia. Carbide Ball Contact
1576-1	1576-2	1576-3	1/2" Dia. Carbide Half Ball Contact
1577-1	1577-2	1577-3	29/64" Dia. Hardened Steel Contact
1578-1	1578-2	1578-3	1" Dia. x .050" thick hardened & hard chrome plated disc contact 0.025"R - 1/2" & 3/4" dia. also available
1579 SP-1	1579 SP-2	1579 SP-3	Special Carbide Ball Contact Specify Ball Diameter required
1580-1	1580-2	1580-3	Offset 3/16" diameter Carbide Ball Contact
1581			Taper contacts for center distance of holes from 1/8" to 1/2" dia.

866-945-5742 /info@willrich.com

M U E L L E R G A G E S

SERIES 1750

DEEP INREACH GROOVE DIAMETER GAGES

FEATURES



- Standard models available with 8", 12", 16", and 20" inreach for hard to reach groove and recess diameters.
- 1.400" to 6.400" inside diameter range with interchangeable lower measuring tips. Tips for larger diameters available. Model 1750 - 8" inreach can be modified to enter 1" entry bore diameter.
- Full 5/8" retraction of upper measuring tip - will check groove-recess diameters up to 5/8" larger than entry bore diameter. Greater retraction available for deeper grooves as optional extra.
- Modified measuring tips readily available for applications not covered by standard range.
- Two point contact standard. Three point contact available.
- Supplied with AGD Group I .0005" dial indicator with rev. counter & 1/8" travel. .0001" & metric indicators available.
- Gage may be used with any AGD Group II style (2 1/4" dia.) Electronic digital indicator with SPC output.
- Finished hardwood storage cases available for all models.

Model 1750

Model 1750 with Analog/Digital Indicator



Gage Model No.	Inreach	Diameter Range	Approx. Weight
1750	8"	*1.400" - 6.400"	1 lb. 14 oz.
1755	12"	*1.400" - 6.400"	2 lb. 2 oz.
1760	16"	*1.400" - 6.400"	2 lb. 6 oz.
1765	20"	*1.400" - 6.400"	2 lb. 10 oz.

Hardwood Storage Cases

No. 1750-1 for model 1750

No. 1755-1 for model 1755

No. 1760-1 for model 1760

No. 1765-1 for model 1765

Ordering Information

Gage supplied with upper measuring tip and one (1) only lower measuring tip selected from ten (10) stock sizes listed (1775-1 through 1775-10). For special applications supply entry bore diameter and groove diameter and we will supply special lower tip at no extra cost. See chart on other side.

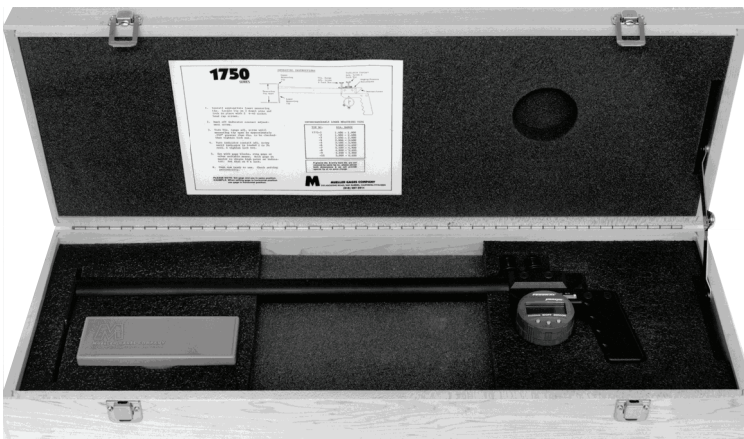

866-945-5742 /info@willrich.com

M U E L L E R G A G E S

INTERCHANGEABLE LOWER MEASURING TIP SELECTION CHART

Tip Number	'A' Dia. Range	
	MIN	MAX
1775-1	1.400" -	1.900"
1775-2	1.900" -	2.400"
1775-3	2.400" -	2.900"
1775-4	2.900" -	3.400"
1775-5	3.400" -	3.900"
1775-6	3.900" -	4.400"
1775-7	4.400" -	4.900"
1775-8	4.900" -	5.400"
1775-9	5.400" -	5.900"
1775-10	5.900" -	6.400"



- 1. Model no. 1765: 20" inreach - Approx. weight 2 lb. 10 oz.
- 2. Model no. 1760: 16" inreach - Approx. weight 2 lb. 6 oz.
- 3. Model no. 1755: 12" inreach - Approx. weight 2 lb. 2 oz.
- 4. Model no. 1750: 8" inreach - Approx. weight 1 lb. 14 oz.

If groove dia. & entry bore dia. are not covered by same tip no., please advise both dimensions & we will provide special tip at no extra charges.

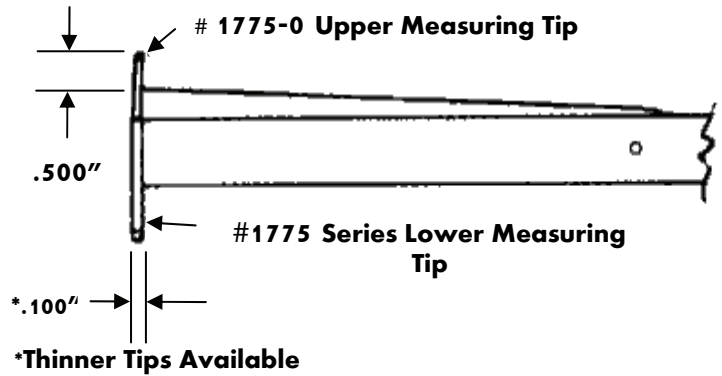
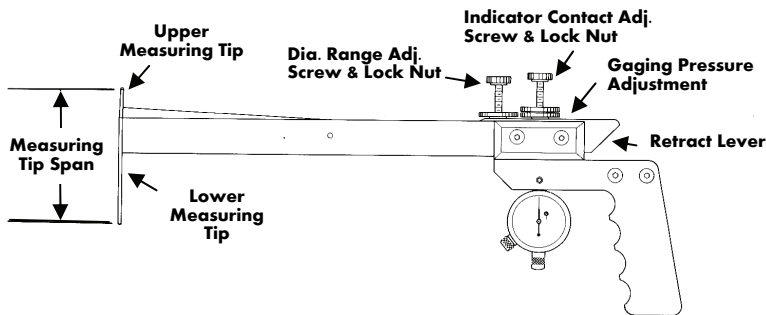
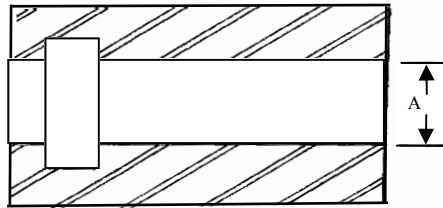

1775 Series Interchangeable Lower Measuring Tips
 Two point contact standard.
 Three point contact available.

Tips are .100" thick.

Can be supplied thinner for narrower grooves.

1775 Tip Set: Includes Lower Tips 1-10 and 1775-0 + .25 Longer Upper Tip.

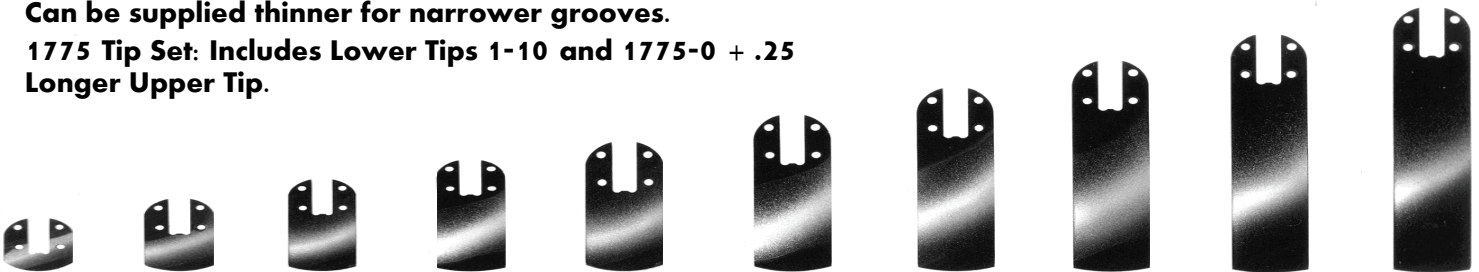

866-945-5742 /info@willrich.com

M U E L L E R G A G E S

SERIES 1900

GROOVE DIAMETER GAGES

FEATURES



- Most versatile gage available for checking groove diameters. Checks both inside and outside diameters.
- Large ID measuring range .187" to 6.875" - OD range 0 to 3.375".
- Designed and manufactured for long life - many units in use for over 20 years.
- Hardened and hard chrome plated measuring tips
- Gage easily set and used.
- Available as single gage or as model 1819 gage set.
- Model 1900 Gage: Supplied with AGD group 1 .0005" dial indicator with rev counter. - .0001" & metric indicators available.
- Features adjustable gaging pressure
- * Model 1900 gage is complete gage less measuring tips. *

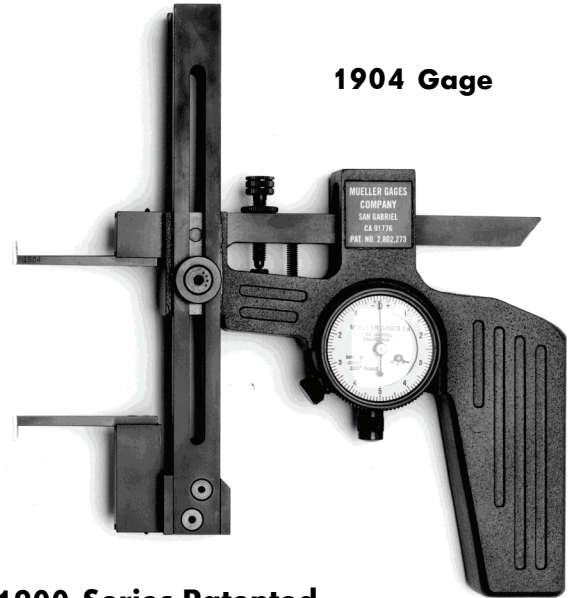

1904 Gage

1900 Series Patented



1901 GAGE
One 1900 Gage body, one set of 1501 tips.
Min. - Max. Dia. Range
.230-6.312



1902 GAGE
One 1900 Gage body, one set of 1502 tips.
Min. - Max. Dia. Range
.187-6.000



1903 GAGE
One 1900 Gage body, one set of 1503 tips.
Min. - Max. Dia. Range
.290-4.500



1904 GAGE
One 1900 Gage body, one set of 1504 tips.
Min. - Max. Dia. Range
.730-6.875



1904-3 GAGE
One 1900 Gage body, one set of 1504-3 tips.
Min. - Max. Dia. Range
.730-6.875.
Three point range.



1918 Gage



Complete 1918 Gage
One 1900 Gage body, one set of 1502, 1503, 1504 tips, plus one 1801 storage case. Min. - Max. Dia. range .187 - 6.875.

866-945-5742 /info@willrich.com

MUELLER GAGES

INSIDE DIAMETER TIPS - 1900 GROOVE GAGE BODY

Tip No.		A	B	C	D	
Gage Model No.	Upper	Lower	Bore. Dia. Range Min - Max	Length of Meas. Tip	Width of Meas. Tip	Depth of Meas. Tip
1901	1501	1501	.230 - 6.312	7/8	.014	.030
1902	1502	1502	.187 - 6.000	7/8	.030	.080
1903	1503	1503	.290 - 4.500	1 1/4	.050	.110
1904	1504	1504	.730 - 6.875	1 1/4	.040	.210
1904-3*	1504	1504-3	.730 - 6.875	1 1/4	.040	.210
1918	1502	1502	.187 - 6.000	7/8	.030	.080
	1503	1503	.290 - 4.500	1 1/4	.050	.110
	1504	1504	.730 - 6.875	1 1/4	.040	.210
1915	1505	1505	1.030 - 7.125	3 3/4	.050	.285
1915-3*	1505	1505-3	1.030 - 7.125	3 3/4	.050	.285

*Cylindrical master required

PLEASE NOTE

The following measuring tips are now available with special width ('C' dimensions) at no extra charge when specified on purchase order.

Measuring Tip No.	Standard Width	Special Width
* 1502	* .030	* .020
* 1503	* .050	* .022
* 1504	* .040	* .020

OUTSIDE DIAMETER TIPS - 1900 GROOVE GAGE BODY

Tip No.		Tip Width	Tip Depth	Gaging Range
Lower	Upper			
1700	1600	.011	.060	0-3.375
1701	1601	.016	.060	0-3.375
1702	1602	.027	.060	0-3.375
1703	1603	.038	.060	0-3.375
1704	1604	.045	.100	0-3.375
1705	1605	.055	.100	0-3.375
1706	1606	.067	.100	0-3.375
1707	1607	.085	.250	0-3.375
1708	1608	.102	.250	0-3.375
1709	1609	.120	.250	0-3.375
	1800	Anvil		

Approx. weight of an average gage with measuring tips is 22 oz. Measuring tips can be reconditioned when worn. Price on request.

Ordering Information

Series 1900 Groove Gages Model Numbers are determined by the selection of tips. See specification Chart for ordering. Gage includes a complete Gage body one .0005" AGD group 1 dial indicator with rev. counter. .0001" & metric indicators available. No. 1801 storage case for all models.

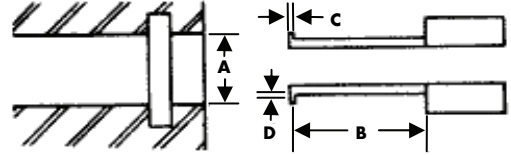

Model 1904 with Analog/Digital Indicator



1904 GAGE with 1900-500 Long Slide. Long Slide increases ID range to 12".



1915 GAGE
One 1915-1 gage body plus one set 1505 tips. Min. - Max. Dia. range 1.030-7.125. Model 1915-1 gage body is model 1915 gage less measuring tips.

1921 Gage - One 1900 gage body with one each 1600-1700 series tips.

1922 Gage - One 1900 gage body with one each 1800 anvil and 1700 series tip.

M U E L L E R G A G E S

318 Agostino Road / San Gabriel, CA 91776-2505
(626) 287-2911 / www.muellergages.com

SERIES 2000

SHALLOW DIAMETER GAGES

A comparator for use in inspection areas or at the machine for checking shallow inside and outside diameters. Also features retraction for checking internal grooves and recesses.



Model 2002



Model 2004

- Check ID's from .8" to 8.5" and OD's from .4" to 8.0" with 2 models.
- Fully adjustable gaging depth from 1/32" to 5/16".
- Five types of standard interchangeable contact points available. Special contacts available too.
- Raised 3 point location rest pads stand gage 1/2" off part to clear hubs, shafts etc.
- Two point contact.
- Supplied with AGD Group 2 .0005" dial indicator with rev. counter.
- For checking internal grooves, models 2002 and 2004 have .500" retraction.
- Gaging direction changed in seconds.
- All contact and wear areas hardened and ground.
- Easily set with gage blocks, ring gage, or qualified part.
- Fitted storage cases available.
- Gaging contacts can be rotated easily as they wear, greatly extending their useful life.

FEATURES



Model No.	2002	2004
Indicator Graduations	.0005"	.0005"
Indicator Travel	.500"	.500"
I.D. Range	.8"-4.4"	.8"-8.5"
O.D. Range	.4"-8.0"	.4"-8.0"
Approx. Weight	16 oz.	24 oz.

866-945-5742 /info@willrich.com

M U E L L E R G A G E S



Plastic Storage Cases:
No. 2005 for Model 2002
No. 2006 for Model 2004

▶ **Contact Points**

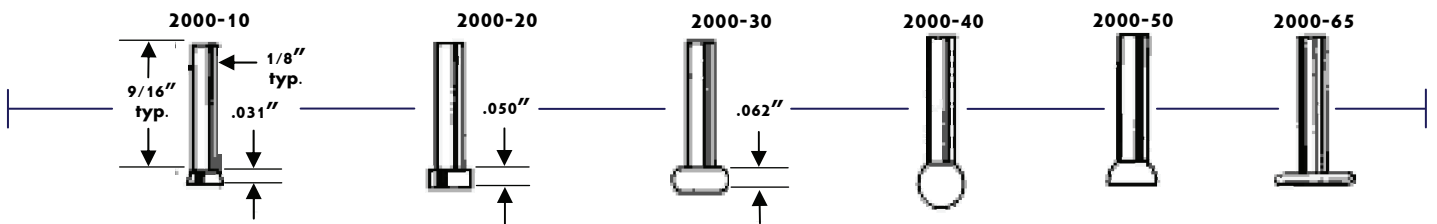

- ▶ **2000-10:**
5/32" Dia.
Hardened & Ground
Tool Steel
- ▶ **2000-20:**
5/32" Dia.
Hardened & Ground
Tool Steel
- ▶ **2000-30:**
3/16" Dia.
Hardened & Ground
Tool Steel
- ▶ **2000-40:**
3/16" Dia.
Full Ball
Carbide
- ▶ **2000-50:**
3/16" Dia.
Half Ball
Carbide
- ▶ **2000-65:**
1/2" Dia.
x .050 Thick
Steel Disc
Hardened &
Hard Chrome
Plated

Gage supplied with No. 2000-10 Contact Points - Special contact points supplied on request

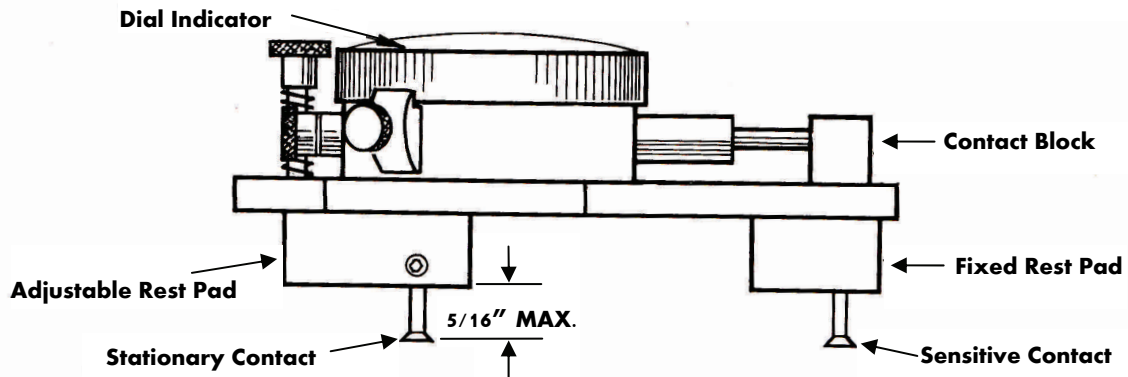

866-945-5742 /info@willrich.com

M U E L L E R G A G E S

SERIES 2900

LIGHTEIGHT ADJUSTABLE LARGE DIAMETER & GROOVE GAGES

For accurate checking of inside and outside diameters, groove diameters, pitch diameters of gears and related dimensions.

FEATURES



- Check diameters by comparing part dimensions to gage blocks. Actual part dimension shown on dial indicator.
- Gage may be used with any AGD Group II style (2 1/4" dia.) Electronic digital indicator with SPC output.
- Gage rests on face of part for fast & dependable 2 point measurement directly across diameter.
- Lightweight—alloy steel airframe tubing gage body.
- Frictionless linear ball bushing movement for precise repeatability.
- Full 3/4" travel (retraction) for checking grooves.
- Large adjustable diameter range.
- 6 1/2" to 60" diameter range with 5 models—larger sizes available.
- Adjustable gaging depth from 0 to 3".
- Positive mechanism instantly reverses gaging direction. No loose parts.
- Fast acting rack & pinion fine adjustment for rapid setting.
- Carbide ball contacts.
- Three carbide dowel gage rests.
- Several standard contact styles available.
- Easily set with gage blocks & 600 series adjustable gage setting stands or qualified part.
- Harwood Storage Cases available for all models.

Model 2910



Model 2910 with Digital Indicator



2900 SERIES SPECIFICATIONS

Model No.	I.D. - O.D. Range	Length	Approx. Wgt.
2910	6-1/2"-14"	23-1/4"	3 lb. 5 oz.
2911	14"-24"	33-1/4"	3 lb. 14 oz.
2912	24"-36"	45-1/4"	4 lb. 10 oz.
2913	26"-48"	57-1/4"	5 lb. 6 oz.
2914	48"-60"	69-1/4"	6 lb. 2 oz.

Gage supplied with AGD Group 2 .0005" dial indicator with rev counter & 1/2" travel & 2930 measuring tips unless otherwise requested. Available with .0001" indicator with .200 travel. Metric indicators available.

866-945-5742 /info@willrich.com

M U E L L E R G A G E S

▶ 3100 Series Reference Masters

3100 series Reference Masters are offered in 5 sizes to accommodate out No. 2900 series Large Diameter Groove Recess Gages. They feature a depth range from 0 to 3" and 7/16" rack & pinion fine adjustment for fast and easy setting. The range blocks are hardened and precision ground and the Reference Master body is made from precision ground and stress relieved alloy steel tubing. This Reference Master may be used with both the No. 2920, 1" diameter and No. 2930, 1/4" diameter measuring tips supplied for the 2900 series gages.

Reference masters are set by the gage after it has been set to the required dimension by gage blocks etc. The reference master can then be placed in the production area to periodically verify the gage setting.

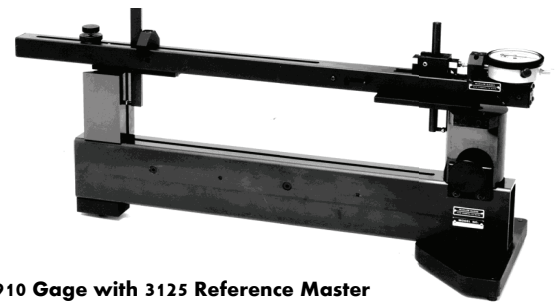

2910 Gage with 3125 Reference Master

Model No.	Inside & Outside Diameter Range	Depth Range
3125	6 1/2" - 14"	0 - 3"
3126	14" - 24"	0 - 3"
3127	24" - 36"	0 - 3"
3128	36" - 48"	0 - 3"
3129	48" - 60"	0 - 3"

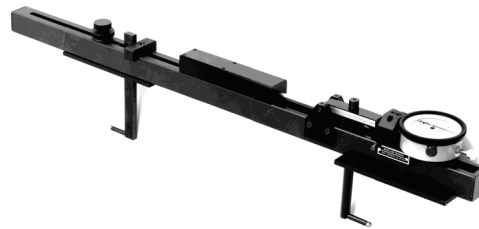
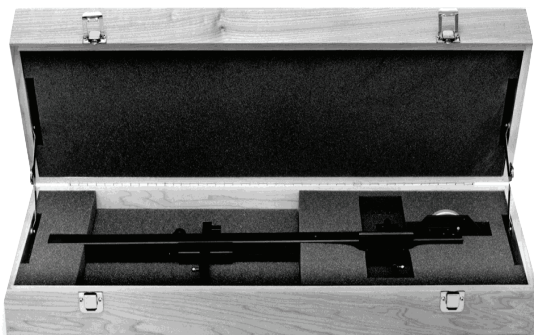

▶ For special applications the 2900 series is available with a full 2" retraction. Available for ID's only.

HARDWOOD STORAGE CASES		
2910-1	For Model	2910
2911-1	For Model	2911
2912-1	For Model	2912
2913-1	For Model	2913
2914-1	For Model	2914

Model 2910 shown ◀ with 600 gage setting stands and gage block setup. Stands position gage at correct height above surface plate to properly contact gage blocks for quick & easy setting of gage.

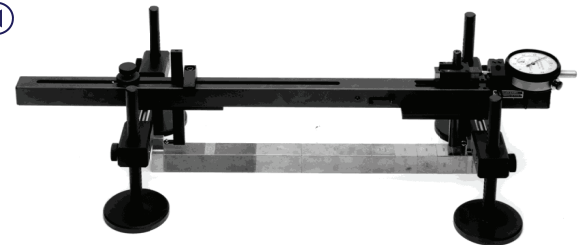

▶ Measuring Tips

Supplied in sets of one each -1 & -2

No. 2930 measuring tips feature .250 dia. grade 25 Carbide balls with 4-48 Thd. on shank. Other ball sizes available. Supplied complete with stems. Discs are hardened and hard chrome plated steel. They may be rotated for additional contact wear surfaces.

Tip No.	Diameter	Thickness
2920-1 & 2	1.000"	.050"
2921-1 & 2	1.000"	.100"
2922-1 & 2	1.000"	.200"
2930-1 & 2	.250"	—

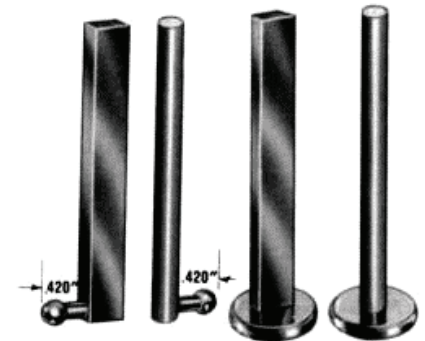

No. 2920-1 through 2930-1 stems are 1/4" x 1/2".

No. 2920-2 through 2930-2 stems are 3/8" dia.

866-945-5742 /info@willrich.com

M U E L L E R G A G E S