



**WILLRICH PRECISION  
INSTRUMENT**  
*THINK MEASUREMENT... THINK WILLRICH*

Ph 866-945-5742 email:sales@willrich.com

## MITUTOYO FIXTURES

ECO-FIX, CAR-FIX AND OPTI-FIX

GENERAL



# Mitutoyo Fixtures – Experience in Accuracy

MITUTOYO FIXTURES

Industrial inspection and quality control rely on precision measuring machines and precision fixturing alike. Reliable and repeatable fixture set-up is a basic requirement for successful and accurate measurement. Therefore fixturing is as important a part of proper quality control as the choice of a suitable CMM, form measuring machine or vision measurement system.

Mitutoyo fixture equipment is designed and manufactured with uncompromising precision in mind. Additionally, universality, flexibility and efficiency are essential aspects for choosing Mitutoyo fixturing systems.

Eco-fix is a modular fixturing system for coordinate measuring machines and form measuring machines. Car-fix consists of a combination of our line-up of RST profiles and vari-fix features adjustable columns which allow free and unrestricted workpiece orientation in any desired set-up position. opti-fix was especially developed for vision and optical measuring systems.

Mitutoyo fixtures set the industrial standard for repeatable and efficient fixturing. The powerful simplicity of our pallet receiver system facilitates the execution of more measurements per shift than any other brand – without impairing the accuracy.

Eco-fix and opti-fix components can be combined by using adapters, additionally increasing performance and flexibility.

Mitutoyo fixture systems are the result of our long-standing experience and constant enhancement in fixturing technology. This is our way to reward our customers' trust in Mitutoyo products.

Mitutoyo fixtures: For measurably better results.



# MITUTOYO FIXTURES





# Systematical Design, Colours for Improved Functionality

Mitutoyo fixture kits series “eco-fix” is a very fast and affordable solution to get workpieces clamped on the measuring machine. In just a few minutes, your fixture is ready for measurement. Therefore, eco-fix is a very attractive alternative to customised jigs.

The modular clamping system for CMM and form measuring machines, eco-fix, allows relaxed working in many ways. For the first time, functions and colours are conjoint in a practice-oriented concept for time-saving economical working and confusion-proof handling.

Systematical design, keeping an eye on the essential: eco-fix concentrates on accomplishing nearly every clamping task in a likewise cost- and performance optimising way. Applications in aerospace, automotive, electronics or medical industry are suited with a full solution. Logically assignable elements in an uncomplicated and user-friendly design build up on the base plate equipped only with threads.

The major advantage of eco-fix is that – in contrast to conventional solutions – no additional joints are required due to the state-of-the-art construction. These are the ideas that count in a daily job routine and make eco-fix noticeably better priced than similar systems – without saving on performance and versatility.

The results are systematic efficiency at compelling profitability and considerably reduced costs at enormous versatility.

Even optically eco-fix sets new highlights. The distinctive modern colouring of the eco-fix components is by far more than a styling feature. Due to the clear optical differentiation of the elements the clamping device is distinctly silhouetted against the workpiece to be measured – a decisive advantage for interactive documentation.

Clear optical differentiation of elements by colour

- Black: base plate
- Violet: brackets
- Orange: build up components
- Silver: Top pieces for workpiece support

Easy way to document your repeatable fixture set-up for reduced variation

- Parts numbers featured on all elements for easy identification of components
- Alpha numeric grid pattern on all base plates for simplified positioning and relocation of elements
- Fits all CMM brands
- Build your individual fixture in only 20 minutes!
- Flexible modular systems
- Fast & affordable
- Suitable for various different workpieces or other measuring equipment
- Easy adaption to product changes
- M6 thread pattern
- Purchase one kit for each workpiece





# MITUTOYO eco-fix

## MITUTOYO eco-fix

Another strong point: Assignment of system components during setup and storage is noticeably easier, faster and cannot be mixed up – thus saving time and labour costs – and once again increasing the economic benefit of eco-fix compared to other clamping systems.

The refreshing appearance and state-of-the-art styling of eco-fix are combined with an outstanding durability and resistibility. The system's base plates are made from hard coated aluminum, the receptacle modules from anodised aluminium – which means long-lasting operation even under rougher conditions. All base plates feature an alpha numeric grid pattern and all elements show their parts numbers, making it easy to identify. Additionally, eco-fix features an extremely high load-carrying capacity.

And: The low own weight of the elements ensures easy and safe handling as well as uncomplicated storing. In eco-fix, lightness meets strength! By the way: eco-fix complements Mitutoyo's repro-fix clamping system featuring receptacle modules made from hardened steel and opti-fix components – approved and successful for many years. eco-fix and repro-fix are combinable and expandable as required.

**Mitutoyo's eco-fix for improved reproducibility and accuracy of inspection!**



# eco-fix Kit XS

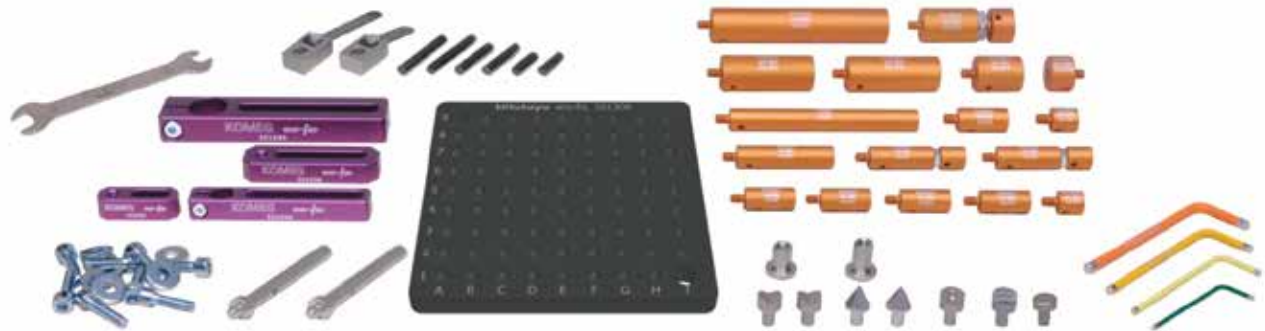

Part No. K551231

Part No.	Qty.	Part name
K551024	2	Location pin ø12x13; eco-fix
K551025	2	Location pin ø12x25; eco-fix
K551026	1	Location pin ø12x50; eco-fix
K551027	1	Location pin ø12x100; eco-fix
K551028	1	Location pin ø20x13; eco-fix
K551029	1	Location pin ø20x25; eco-fix
K551030	1	Location pin ø20x50; eco-fix
K551031	1	Location pin ø20x100; eco-fix
K551306	1	Base plate 125x125; eco-fix
K551035	1	Receiver bracket small eco-fix
K551036	1	Receiver bracket large eco-fix
K551040	1	Adjustable location pin ø20
K551041	2	Adjustable location pin ø12
K551042	3	Location pin ø 12 mm with bore 6 mm
K551044	1	Receiver bracket L = 90; ø 12 mm
K551045	1	Receiver bracket L = 120; ø 20 mm
K550716	2	Straight pin with thread, M6x75
K550279	1	Spring clip, ø 8 mm, L = 60 mm
K550554	1	Spring clip, ø 8 mm, L = 40 mm
K550262	2	V-block mini, ø12mm
K550261	2	Cone receiver mini, ø12mm
K550250	1	Stopper element mini, ø 6mm
K550247	1	Back square mini, ø 6mm
K551069	1	Flat top ø 12 mm
K551046	1	Slotted nut for receiver bracket h = 12 mm
K551047	1	Slotted nut for receiver bracket h = 15 mm
K550888	2	Straight pin ø 6 mm x 20 mm
K550889	2	Straight pin ø 6 mm x 30 mm
K550890	2	Straight pin ø 6 mm x 40 mm
K551050	1	Allen key 2 mm
K551051	1	Allen key 3 mm
K551052	1	Allen key 4 mm
K551053	1	Allen key 5 mm
K551054	1	Double open-ended spanner 10-17
K550563	2	Cylinder head screw M6 x 25
K550110	6	Cylinder head screw M6 x 20
K550591	8	Washer ø 6.4 mm x ø 17 mm
	61	

# eco-fix Kit S

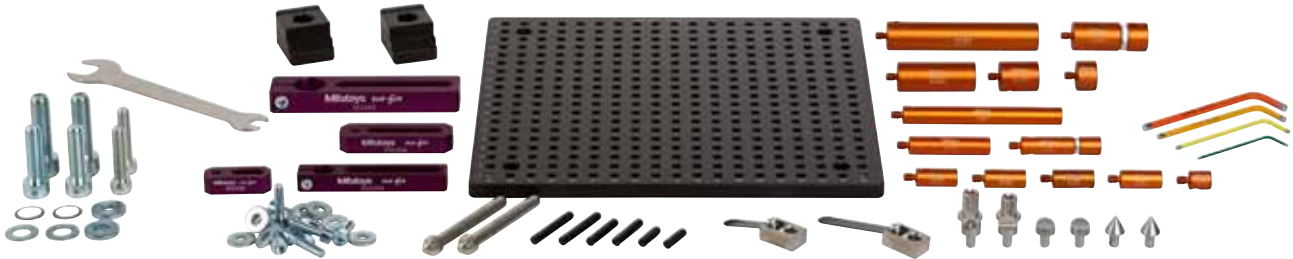

Part No. K551048

Part No.	Qty.	Part name
K551024	1	Location pin ø 12 mm x 13 mm
K551025	1	Location pin ø 12 mm x 25 mm
K551026	1	Location pin ø 12 mm x 50 mm
K551027	1	Location pin ø 12 mm x 100 mm
K551028	1	Location pin ø 20 mm x 13 mm
K551029	1	Location pin ø 20 mm x 25 mm
K551030	1	Location pin ø 20 mm x 50 mm
K551031	1	Location pin ø 20 mm x 100 mm
K551032	2	Clamping claw eco-fix
K551034	1	Base plate 250 mm x 250 mm
K551035	1	Receiver bracket small
K551036	1	Receiver bracket large
K551040	1	Adjustable location pin ø 20 mm
K551041	1	Adjustable location pin ø 12 mm
K551042	3	Location pin ø 12 mm with bore 6 mm
K551044	1	Receiver bracket L = 90; ø 12 mm
K551045	1	Receiver bracket L = 120; ø 20 mm
K550716	2	Straight pin with thread
K550279	1	Spring clip, ø 8 mm, L = 60 mm
K550554	1	Spring clip, ø 8 mm, L = 40 mm
K550262	2	V-block mini
K550261	2	Cone receiver mini
K550250	1	Stopper element mini
K550247	1	Back square mini
K550888	2	Straight pin ø 6 mm x 20 mm
K550889	2	Straight pin ø 6 mm x 30 mm
K550890	2	Straight pin ø 6 mm x 40 mm
K551046	1	Slotted nut for receiver bracket h = 12 mm
K551047	1	Slotted nut for receiver bracket h = 15 mm
K551050	1	Allen key 2 mm
K551051	1	Allen key 3 mm
K551052	1	Allen key 4 mm
K551053	1	Allen key 5 mm
K551054	1	Double open-ended spanner SW10
K550591	8	Washer ø 6.4 mm x ø 17 mm
K550110	6	Cylinder head screw M6 x 20
K550563	2	Cylinder head screw M6 x 25
	59	





# eco-fix Kit L



Part No. K551549

Part No.	Qty.	Part name
K551024	2	Location pin ø 12 mm x 13 mm
K551025	2	Location pin ø 12 mm x 25 mm
K551026	2	Location pin ø 12 mm x 50 mm
K551027	2	Location pin ø 12 mm x 100 mm
K551028	2	Location pin ø 20 mm x 13 mm
K551029	2	Location pin ø 20 mm x 25 mm
K551030	2	Location pin ø 20 mm x 50 mm
K551031	2	Location pin ø 20 mm x 100 mm
K551032	3	Clamping claw eco-fix
K551033	1	Base plate 500 mm x 400 mm
K551035	2	Receiver bracket small
K551036	1	Receiver bracket large
K551040	2	Adjustable location pin ø 20 mm
K551041	2	Adjustable location pin ø 12 mm
K551042	3	Location pin ø 12 mm with bore 6 mm
K551043	3	Location pin ø 20 mm with bore 8 mm
K551044	1	Receiver bracket L = 90 mm, ø 12 mm
K551045	2	Receiver bracket L = 120 mm, ø 20 mm
K550716	3	Straight pin with thread
K550279	2	Spring clip, ø 8 mm, L = 60 mm
K550554	1	Spring clip, ø 8 mm, L = 40 mm
K550262	2	V-Block mini
K550261	2	Cone receiver mini
K550250	1	Stopper element mini
K550247	1	Back square mini
K550058	2	V-block
K550365	2	Cone Receiver
K550982	1	Stopper element
K550248	1	Back square
K550888	2	Straight pin ø 6 mm x 20 mm
K550889	2	Straight pin ø 6 mm x 30 mm
K550890	2	Straight pin ø 6 mm x 40 mm
K550000	2	Straight pin ø 8 mm x 30 mm
K550001	2	Straight pin ø 8 mm x 50 mm
K550002	2	Straight pin ø 8 mm x 65 mm
K551046	1	Slotted nut for receiver bracket h = 12 mm
K551047	2	Slotted nut for receiver bracket h = 15 mm
K551050	1	Allen key 2 mm
K551051	1	Allen key 3 mm
K551052	1	Allen key 4 mm
K551053	1	Allen key 5 mm
K551054	1	Double open-ended spanner SW10
K550591	12	Washer D = 6.4 mm / D = 17 mm
K550110	6	Cylinder head screw M6 x 20 mm
K550563	6	Cylinder head screw M6 x 25 mm
	98	



# eco-fix Kit MAG-S

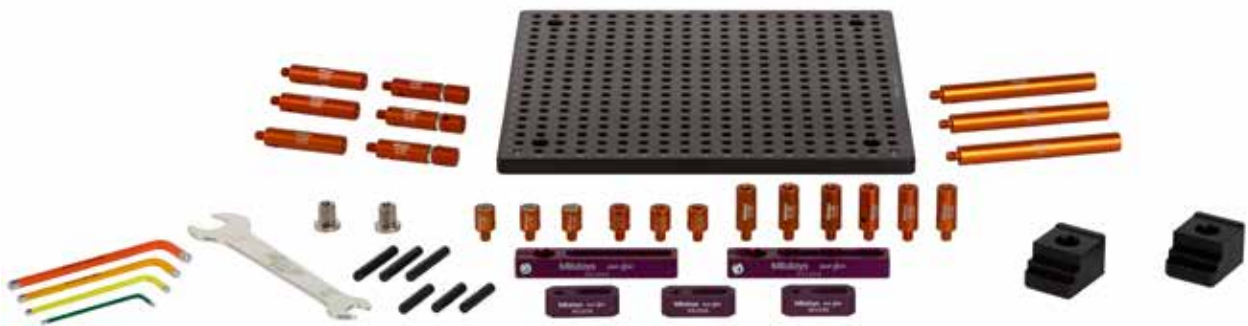

Part No. K551089

Part No.	Qty.	Part name
K551024	3	Location pin $\varnothing$ 12 mm x 13 mm
K551025	3	Location pin $\varnothing$ 12 mm x 25 mm
K551026	3	Location pin $\varnothing$ 12 mm x 50 mm
K551027	3	Location pin $\varnothing$ 12 mm x 100 mm
K551032	2	Clamping claw eco-fix
K551034	1	Base plate 250 mm x 250 mm
K551035	3	Receiver bracket small
K551041	3	Adjustable Location pin $\varnothing$ 12 mm
K551042	3	Location pin $\varnothing$ 12 mm with bore 6 mm
K551044	2	Receiver bracket L = 90 mm; $\varnothing$ 12 mm
K550889	3	Straight pin $\varnothing$ 6 mm x 30 mm
K551073	3	Magnetic receiver $\varnothing$ 20 mm
K550890	3	Straight pin $\varnothing$ 6 mm x 40 mm
K551046	2	Slotted nut for receiver bracket h = 12 mm
K551050	1	Allen key 2 mm
K551051	1	Allen key 3 mm
K551052	1	Allen key 4 mm
K551053	1	Allen key 5 mm
K551054	1	Double open-ended spanner SW 10-17
K550591	15	Washer D= 6.4 mm / D= 17 mm
K550110	10	Cylinder head screw M6 x 20 mm
K550563	5	Cylinder head screw M6 x 25 mm
	70	



# eco-fix Kit MAG-L



Part No. K551590

Part No.	Qty.	Part name
K551028	3	Location pin ø 20 mm x 13 mm
K551029	3	Location pin ø 20 mm x 25 mm
K551030	3	Location pin ø 20 mm x 50 mm
K551031	3	Location pin ø 20 mm x 100 mm
K551032	3	Clamping claw eco-fix
K551033	1	Base plate 500 mm x 400 mm
K551036	3	Receiver bracket large
K551040	3	Adjustable Location pin ø 20 mm
K551043	3	Location pin ø 20 mm with bore 8 mm
K551045	2	Receiver bracket L = 120 mm; ø 20 mm
K551074	3	Magnetic receiver ø 20 mm
K550000	3	Straight pin ø 8 mm x 30 mm
K550001	3	Straight pin ø 8 mm x 50 mm
K551050	1	Allen key 2 mm
K551051	1	Allen key 3 mm
K551052	1	Allen key 4 mm
K551053	1	Allen key 5 mm
K551054	1	Double open-ended spanner SW 10-17
K550591	20	Washer D= 6.4 mm / D= 17 mm
K550110	10	Cylinder head screw M6 x 20 mm
K550563	10	Cylinder head screw M6 x 25 mm
	79	

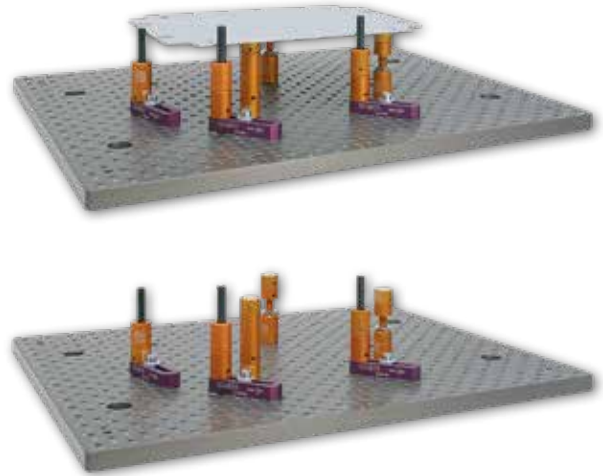



# eco-set opti S



Part No. K551233

Part No.	Qty.	Part name
K551215	1	Base plate eco- and opti-fix for contour illumination, 250x250mm
K551036	1	Receiver bracket large; eco-fix
551035	2	Receiver bracketsmall eco-fix
K551026	2	Location pin ø12x50; eco-fix
K551025	2	Location pin ø12x25; eco-fix
K551024	2	Location pin ø12x13; eco-fix
K551042	6	Location pin ø12 m. Passb. ø6
K551041	1	Adjustable location pin ø12
K551189	4	Adaptor eco/opti ø6mm
K550302	2	Receiver pin stepped L = 80 mm
K550303	2	Receiver pin stepped L = 100 mm
K550990	1	Rectangular receiver pin L = 50 mm
K550323	2	Rectangular receiver pin L = 25 mm
K550971	1	Prismatic receiver / locator
K550972	1	Prismatic eccentric receiver
K550970	1	Eccentric receiver
K550980	2	Spring clip large 30°
K550889	1	Straight pin 6 x 30 mm
K550890	2	Straight pin ø 6 mm x 40mm
K551053	1	Allen key 2 mm
K551050	1	Allen key 5 mm
K551054	1	Double open-ended spanner 10-17
K550563	3	Cylinder head screw M6 x 25
K550591	3	Washer ø 6.4 mm x ø 17 mm
	45	

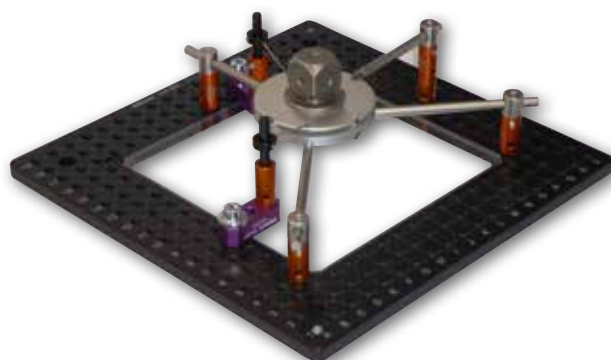
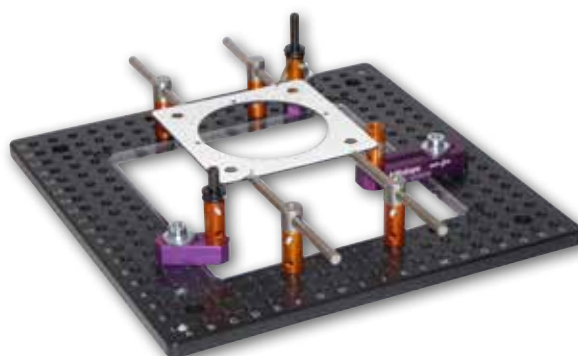

# eco-fix Kit quick S



Part No. K551302

Part No.	Qty.	Part name
K551034	1	Base plate 250x250; eco-fix
K551303	3	Joint stand eco-fix S20
K551227	3	Receiving bracket for joint stand
K551043	3	Receiver bolt ø20 m. Passb. Ø8;
K551228	1	Clamping thimble, KT1 Alu, M6
K550716	2	Cylinder pin with thread, M6x75
K550279	2	Springclip without ball ø8x60
K551229	1	Double open ended wrench 7-8mm
K551032	2	Clamping jaw 10, 15; eco-fix
K551070	2	Flat top ø 20 mm x 22 mm
K550982	1	Stopper element ø 20



# eco-fix Kit quick-rail



Part No. K550914S

Part No.	Qty.	Part name
K550911	1	Clamping profile rail 800 mm
K550199	2	Clamping profile rail with slot 500 mm
K550908	2	Clamping claw
K550909	2	Corner connector
K550907	3	Clamping plate
K551040	3	Adjustable Location pin $\varnothing$ 20 mm
K551043	3	Location pin $\varnothing$ 20 mm with bore 8 mm
K551030	2	Location pin $\varnothing$ 20 mm x 50 mm
K551029	3	Location pin $\varnothing$ 20 mm x 25 mm
K550279	1	Spring clip, $\varnothing$ 8 mm, L = 60 mm
K550554	1	Spring clip, $\varnothing$ 8 mm, L = 40 mm
K550042	1	Back square 30 mm x 30 mm
K550249	1	Stopper element 30 mm x 25 mm
K550248	1	Back square $\varnothing$ 20 mm
K550982	1	Stopper element $\varnothing$ 20 mm
K551070	1	Flat top $\varnothing$ 20 mm
K550716	1	Straight pin with thread
K551054	1	Double open-ended spanner SW 10/17
K550658	1	Hexagon spanner with t-handle
	31	





# eco-fix Kit Form S



Part No. K551133

Part No.	Qty.	Part name
K551038	1	Adaptor plate ø 150 mm
K551024	1	Location pin ø 12 mm X 13 mm
K551025	1	Location pin ø 12 mm X 25 mm
K551026	1	Location pin ø 12 mm X 50 mm
K551027	1	Location pin ø 12 mm X 100 mm
K551028	1	Location pin ø 20 mm X 13 mm
K551029	1	Location pin ø 20 mm X 25 mm
K551030	1	Location pin ø 20 mm X 50 mm
K551031	1	Location pin ø 20 mm X 100 mm
K551035	1	Receiver bracket small
K551036	1	Receiver bracket large
K551040	1	Adjustable location pin ø 20 mm
K551041	1	Adjustable location pin ø 12 mm
K551042	3	Location pin ø 12 mm with bore ø 6mm
K551044	1	Receiver bracket L = 90; ø 12 mm
K550716	1	Straight pin with thread
K550279	1	Spring clip, d= 8 mm, L = 60 mm
K551069	1	Flat top ø 12 mm
K550262	1	V-block mini
K550261	2	Cone receiver mini
K550250	1	Stopper element mini
K550247	1	Back square mini
K550888	2	Straight pin Ø 6 mm x 20 mm
K550889	2	Straight pin Ø 6 mm x 30 mm
K550890	2	Straight pin Ø 6 mm x 40 mm
K551046	1	Slotted nut for receiver bracket h=12mm
K551050	1	Allen key 2 mm
K551051	1	Allen key 3 mm
K551052	1	Allen key 4 mm
K551053	1	Allen key 5 mm
K551054	1	Double open ended spanner 10-17
K550591	1	Washer ø 6,4 mm / ø 17 mm
K550110	8	Cylinder head screw M6 x 20 mm
K550563	6	Cylinder head screw M6 x 25 mm
	53	



# eco-fix Kit Form L



Part No. K551134

Part No.	Qty.	Part name
K551039	1	Adaptor plate $\varnothing$ 200 mm
K551024	1	Location pin $\varnothing$ 12 mm X 13 mm
K551025	1	Location pin $\varnothing$ 12 mm X 25 mm
K551026	1	Location pin $\varnothing$ 12 mm X 50 mm
K551027	2	Location pin $\varnothing$ 12 mm X 100 mm
K551028	2	Location pin $\varnothing$ 20 mm X 13 mm
K551029	2	Location pin $\varnothing$ 20 mm X 25 mm
K551030	2	Location pin $\varnothing$ 20 mm X 50 mm
K551031	1	Location pin $\varnothing$ 20 mm X 100 mm
K551035	1	Receiver bracket small
K551036	1	Receiver bracket large
K551040	2	Adjustable location pin $\varnothing$ 20 mm
K551041	1	Adjustable location pin $\varnothing$ 12 mm
K551042	2	Location pin $\varnothing$ 12 mm with bore $\varnothing$ 6 mm
K551043	3	Location pin $\varnothing$ 20 mm with bore $\varnothing$ 8 mm
K551044	1	Receiver bracket L=90; $\varnothing$ 12 mm
K551045	1	Receiver bracket L=120; $\varnothing$ 20 mm
K550716	2	Straight pin with thread
K550279	2	Spring clip, $d=8$ mm, L= 60 mm
K550262	1	V-block mini
K550261	2	Cone receiver mini
K550250	1	Stopper element mini
K550247	1	Back square mini
K550058	1	V-block
K550365	2	Cone receiver
K550982	1	Stopper element
K550248	1	Back square
K550888	2	Straight pin $\varnothing$ 6 mm x 20 mm
K550889	2	Straight pin $\varnothing$ 6 mm x 30 mm
K550890	2	Straight pin $\varnothing$ 6 mm x 40 mm
K550000	2	Straight pin $\varnothing$ 8 mm x 30 mm
K550001	2	Straight pin $\varnothing$ 8 mm x 50 mm
K550002	2	Straight pin $\varnothing$ 8 mm x 95 mm
K551046	1	Slotted Nut for receiver bracket h= 12 mm
K551047	1	Slotted Nut for receiver bracket h= 15 mm
K551050	1	Allen key 2 mm
K551051	1	Allen key 3 mm
K551052	1	Allen key 4 mm
K551053	1	Allen key 5 mm
K551054	1	Double open ended spanner 10-17
K550591	1	Washer $\varnothing$ 6.4 mm / $\varnothing$ 17 mm
K550110	12	Cylinder head screw M6 x 20 mm
K550563	6	Cylinder head screw M6 x 25 mm
	82	



# Extension Sets



Part No. K551129



Part No. K551130

## Receiver brackets 1

Part No.	Qty.	Part name
K551044	3	Receiving bracket L = 90 mm, ø 12 mm
K551035	3	Receiver bracket small L = 40 mm, M6
K551046	3	Slotted nut h = 12 mm
	9	

## Receiver brackets 2

Part No.	Qty.	Part name
K551045	3	Receiving bracket L = 120 mm, ø 20 mm
K551036	3	Receiver bracket large L = 70 mm, M6
K551047	3	Slotted nut h = 15 mm
	9	



Part No. K551132



Part No. K551131

## Joints 1

Part No.	Qty.	Part name
K551075	3	Turn-swivel joint ø 12 mm
K551076	3	Turn-swivel joint ø 20 mm
	6	

## Magnet 1

Part No.	Qty.	Part name
K551073	5	Magnetic receiver ø 12 mm
K551074	5	Magnetic receiver ø 20 mm
	10	





Part No. K551123

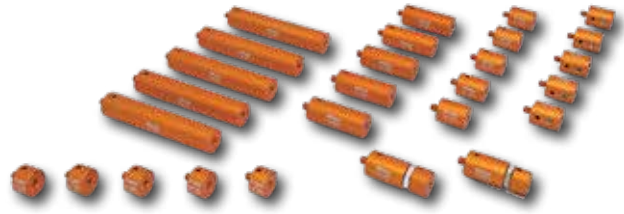

Part No. K551124

**Location pins 1**

Part No.	Qty.	Part name
K551024	5	Location pin $\varnothing$ 12 mm x 13 mm
K551025	5	Location pin $\varnothing$ 12 mm x 25 mm
K551026	5	Location pin $\varnothing$ 12 mm x 50 mm
K551027	5	Location pin $\varnothing$ 12 mm x 100 mm
K551042	5	Location pin $\varnothing$ 12 mm with hole $\varnothing$ 6 mm
K551041	2	Adjustable location pin $\varnothing$ 12 mm
	27	

**Location pins 2**

Part No.	Qty.	Part name
K551028	5	Location pin $\varnothing$ 20 mm x 13 mm
K551029	5	Location pin $\varnothing$ 20 mm x 25 mm
K551030	5	Location pin $\varnothing$ 20 mm x 50 mm
K551031	5	Location pin $\varnothing$ 20 mm x 100 mm
K551043	5	Location pin $\varnothing$ 20mm with hole $\varnothing$ 8 mm
K551040	2	Adjustable location pin $\varnothing$ 20 mm
	27	



Part No. K551126



Part No. K551127

**Supporting elements 1**

Part No.	Qty.	Part name
K551069	3	Flat top $\varnothing$ 12 mm
K550250	3	Stopper element mini $\varnothing$ 12 mm
K550247	2	Back square mini $\varnothing$ 12 mm
K550262	2	V-block mini $\varnothing$ 12 mm
K551071	5	Sphere top $\varnothing$ 12 mm
K550261	2	Cone receiver mini $\varnothing$ 12 mm
	17	

**Supporting elements 2**

Part No.	Qty.	Part name
K551070	3	Flat top $\varnothing$ 20 mm
K550982	3	Stopper element $\varnothing$ 20 mm
K550248	2	Back square $\varnothing$ 20 mm
K550058	2	V-block $\varnothing$ 20 mm
K551072	5	Sphere top $\varnothing$ 20 mm
K550365	2	Cone receiver $\varnothing$ 20 mm
	17	

# Extension sets



Part No. K551125



Part No. K551128

## Clamping elements 1

Part No.	Qty.	Part name
K550716	5	Straight pin with thread
K550554	2	Spring clip, $\varnothing$ 8 mm L= 40 mm
K550279	3	Spring clip, $\varnothing$ 8 mm L= 60 mm
	10	

## Straight pins

Part No.	Qty.	Part name
K550888	5	Straight pin mini $\varnothing$ 6 mm x 20 mm
K550889	5	Straight pin mini $\varnothing$ 6 mm x 40 mm
K550890	5	Straight pin mini $\varnothing$ 6 mm x 60 mm
K550000	5	Straight pin $\varnothing$ 8 mm x 30 mm
K550001	5	Straight pin $\varnothing$ 8 mm x 50 mm
K550002	5	Straight pin $\varnothing$ 8 mm x 65 mm
K550003	5	Straight pin $\varnothing$ 8 mm x 85 mm
	35	



# FixtureBuilder Software

The free of charge software FixtureBuilder enables the user to easily plan and set up his CMM fixture in just a few minutes. Repeatable fixturing has never been easier and at a better price performance ratio.

"FixtureBuilder" is a software tool that allows users to create virtual clamping fixtures quickly and easily. Users can choose whether to set the virtual fixture up manually or to allow the software's "AutoMode" to perform the task.

The interactive "AutoMode" operating mode guides the user step by step to a finalized clamping fixture. Only very few data need to be input, for example the choice of component to be clamped or the position and type of contact and tensioning points. This data is sufficient to enable FixtureBuilder to independently create a complete clamping fixture.

- Fixture building by mouse click
- Ideal for online programming
- Parts list with material overview
- Documented structure
- Automatic weight determination
- allows data to be imported in Acis (\*.sat), Iges (\*.igs) and Step (\*.stp) formats

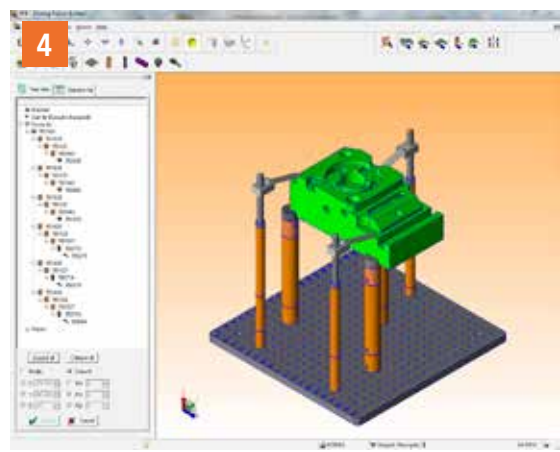
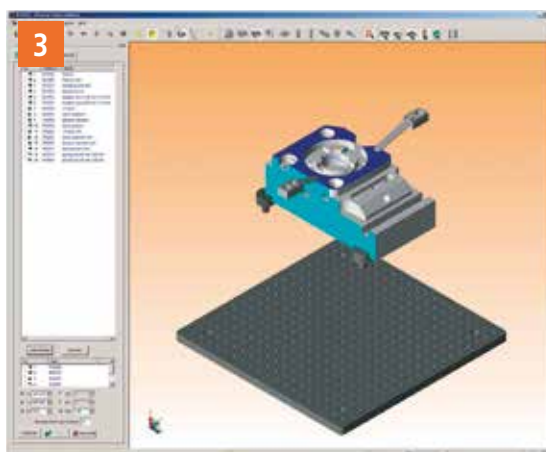
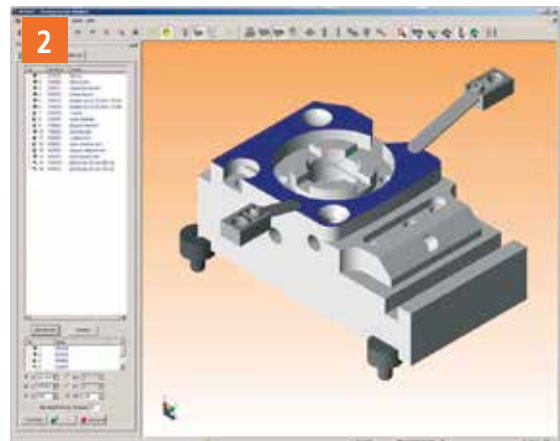
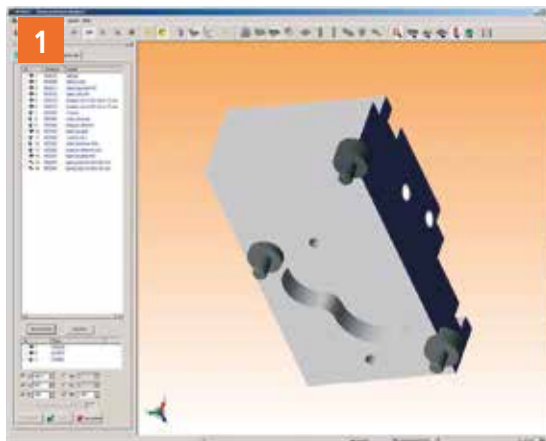



FixtureBuilder software allows data to be imported in Acis (\*.sat), Iges (\*.igs) and Step (\*.stp) formats. The export functions it offers include Hoops file (\*.hsf), Autodesk (\*.dwf), 3d PDF (\*.pdf) and Acis Files (\*.sat). Integrated into Mitutoyo's MCOSMOS CMM software, FixtureBuilder allows data to be processed in all MCOSMOS import formats. The fixture design can be imported into the measuring software, either on its own or complete with component, and thus be used for offline programming of the coordinate measuring machine.

A parts list with assembly instructions is available in various output formats for the assembly of the real fixture created in FixtureBuilder. The 3-D function in PDF format is especially practical as it allows limitless variations on the view of the fixture model in the PDF document. The virtual design can therefore be examined from all possible views and positions.

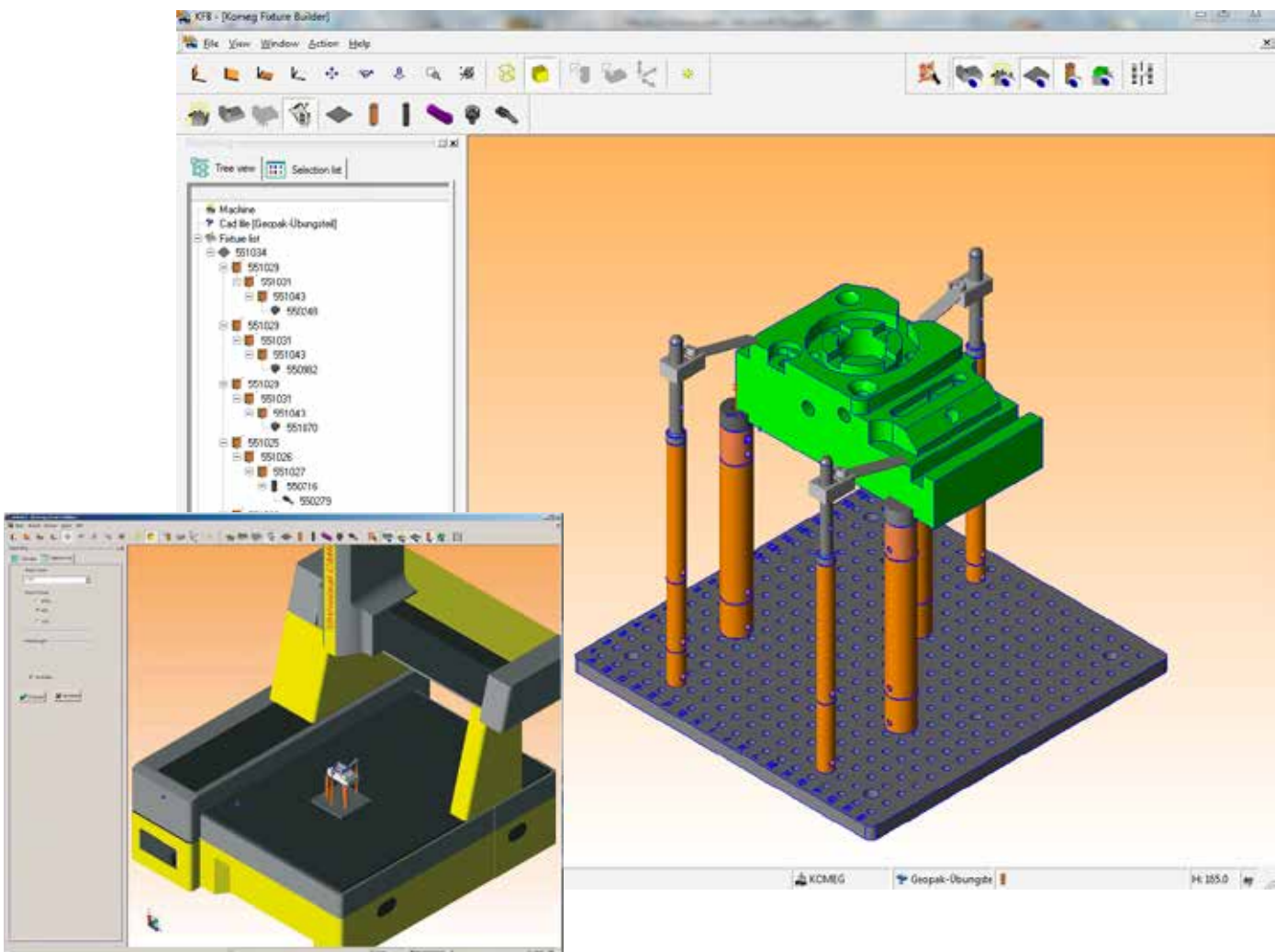

# Special base plates for Mitutoyo CMM

The base plates provide multiple possibilities for fixing fixtures and accessories or even the direct construction of jigs on the CMM.

They are available in different sizes, in the layout specially adapted to the respective Mitutoyo CMM. Depending on the design, the base plates are supplied in 1 to 4 handy segments, which make mounting on the CMM much easier. The basic base plates are designed for direct mounting on the granite tables of the Mitutoyo CMMs. They are precision machined from a high quality aluminum alloy and provided with a surface finish that makes the base plates extremely durable.

They also protect the valuable granite base of the CMM. The base plates are equipped with fixing threads M6 in a 25mm / 50mm grid to directly position and build up fixtures for e.g. with the elements from the Mitutoyo clamping system eco-fix or also for fixing aids such as chucks, positioning angle or the like. In addition, threads M8 are used to attach CMM accessories such as Measuring balls or stylus rack which are located in the edge area on the base plates.

Part No.	Measuring range		Plate size	CMM	Number of elements
	X	Y	LxWxD		
K551186	500	400	570 x 540 x 15	CRYSTA-Apex S 544	1
K551187	500	700	605 x 840 x 15	CRYSTA-Apex S 574	1
K551190	700	700	830 x 840 x 15	CRYSTA-Apex S 776	2
K551191	700	1000	815 x 1140 x 15	CRYSTA-Apex S 7106	2
K551192	900	1000	970 x 1140 x 15	CRYSTA-Apex S 9106/9108	2
K551193	900	1600	970 x 1740 x 15	CRYSTA-Apex S 9166/9168	3
K551194	900	2000	970 x 2140 x 15	CRYSTA-Apex S 9206/9208	4
K515432			120 x 415 x 15	Fixing plate for MRS-400	1
K515433			100 x 730 x 15	Fixing plate for MRS-600	1

base plate K551186  
for CMM CRYSTA-Apex S 544

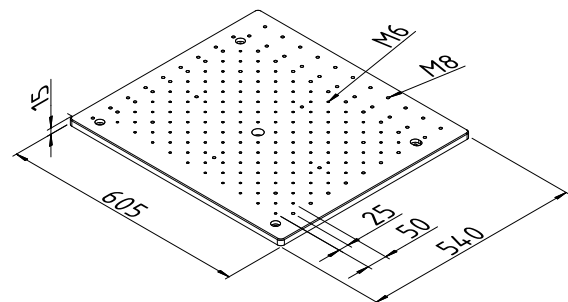

base plate K551187  
for CMM CRYSTA-Apex S 574

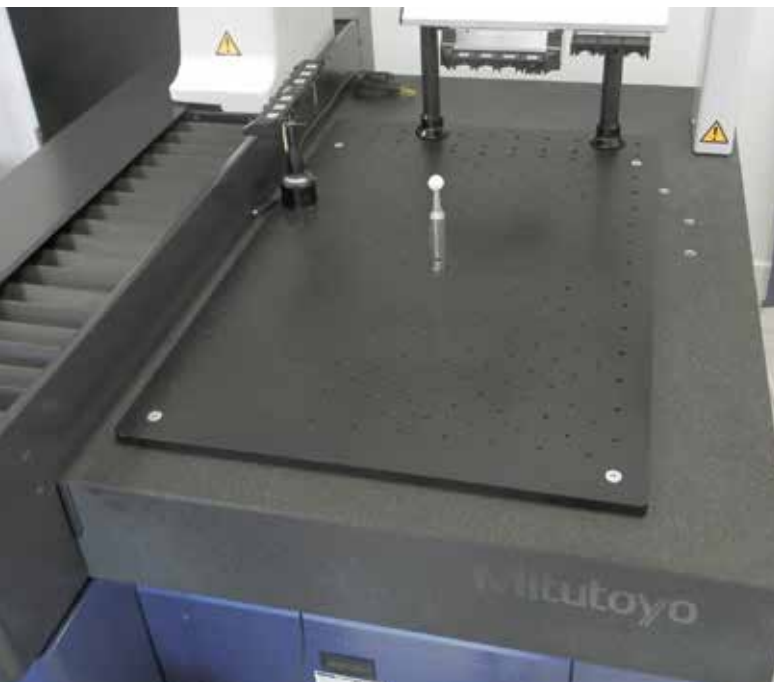
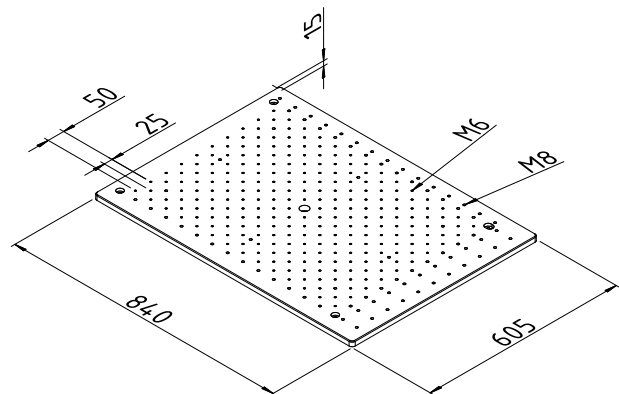

K551187 mounted on CRYSTA-APEX S 574

**base plate K551190  
for CMM CRYSTA-Apex S776**

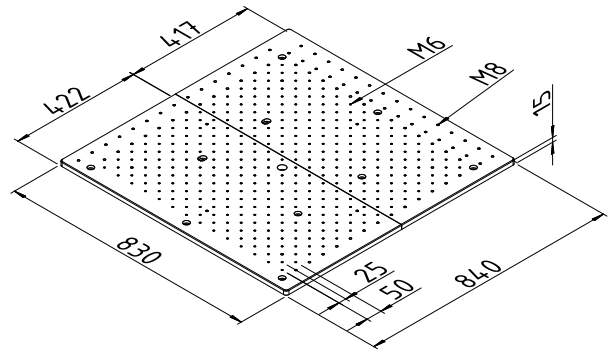
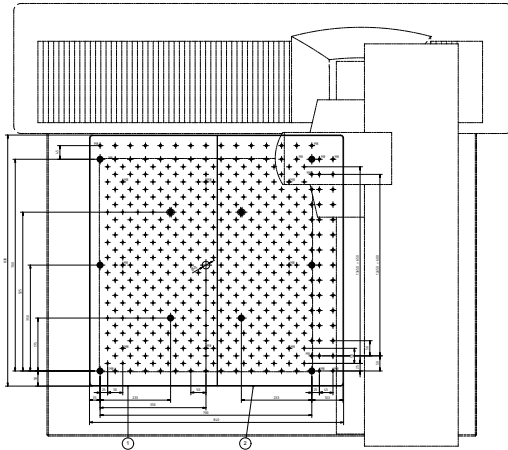

**base plate K551191  
for CMM CRYSTA-Apex S 7106**

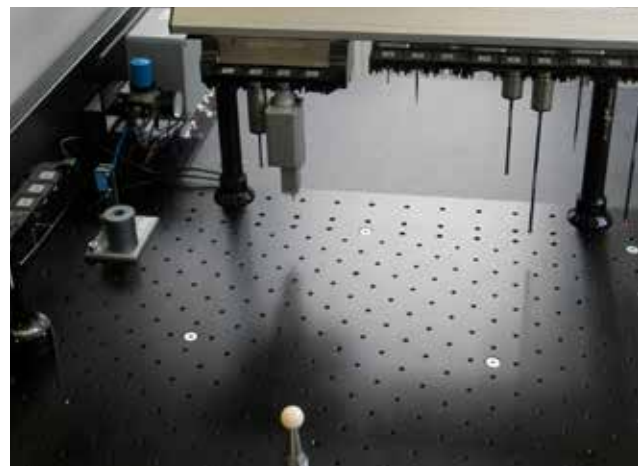
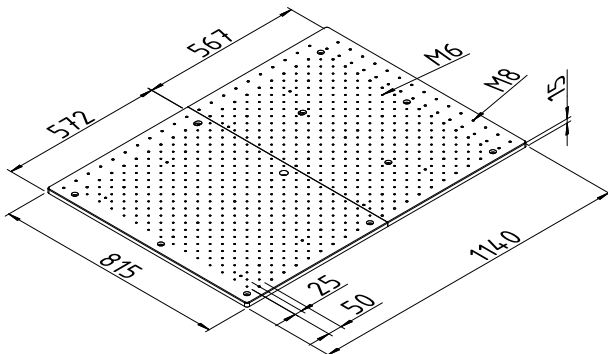
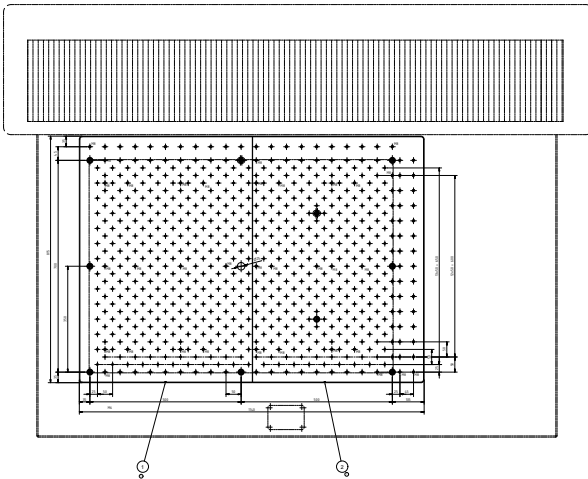

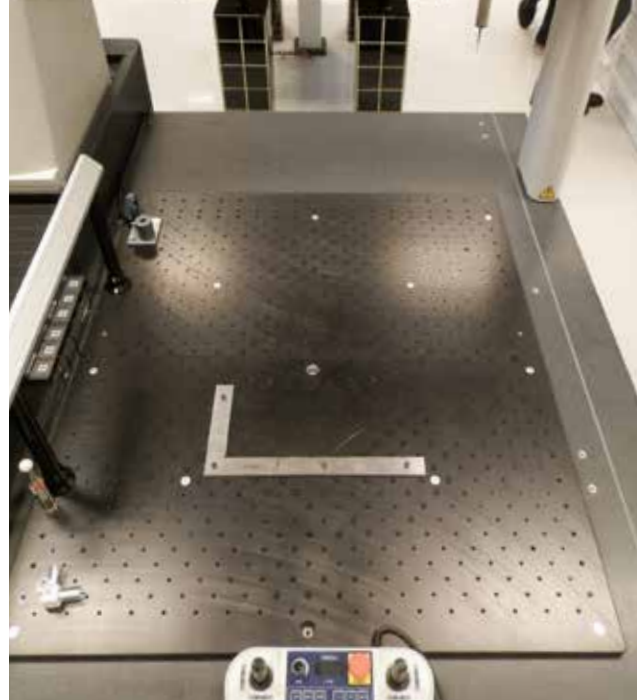

base plate K551192  
for CMM CRYSTA-Apex S 9106/9108

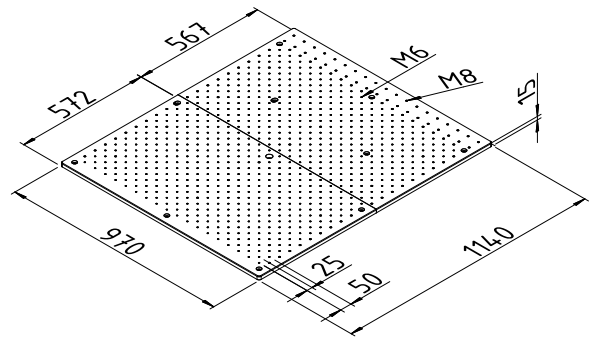
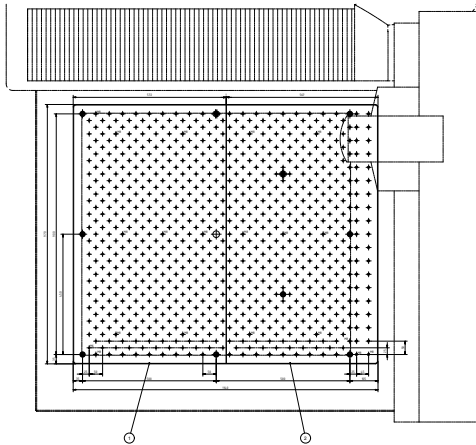

base plate K551193  
for CMM CRYSTA-Apex S 9166/9168

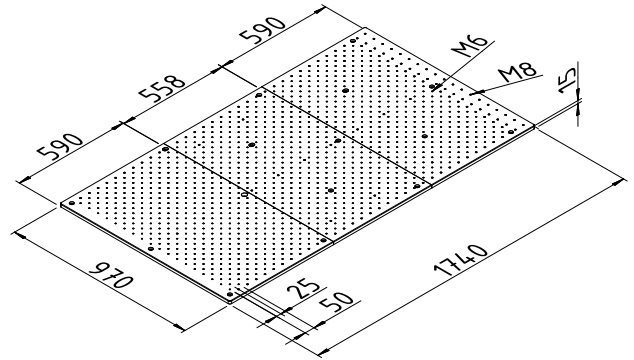
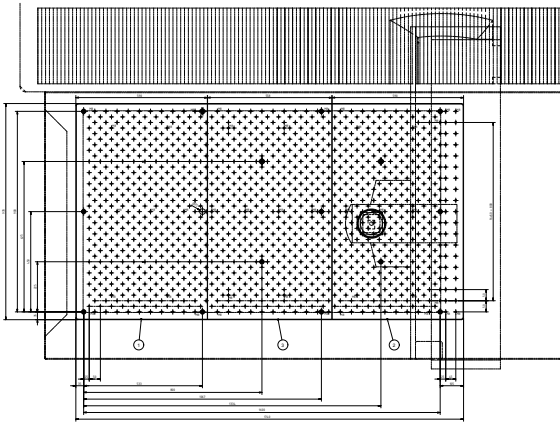

base plate K551194  
for CMM CRYSTA-Apex S 9206/9208

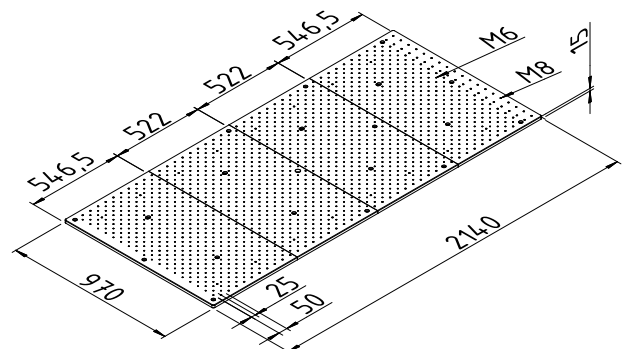
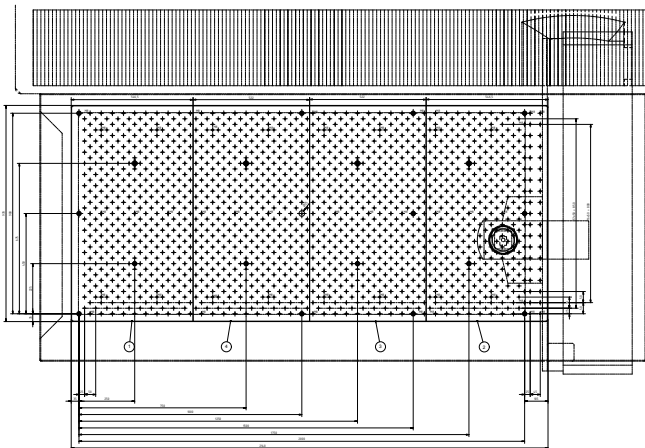



## eco-fix rail KIT S

Typ hier uw tekst



Part No. K551197

Part No.	Qty.	Part name
K551196	2	eco-fix positioning rail L=370mm
K580709	3	Threaded spindle M6
K550122	3	Flat washer D= 6,4
K900868	4	Washer
K550562	3	Hexnut M6
K904397	4	Lens head screw Din ULS HLG

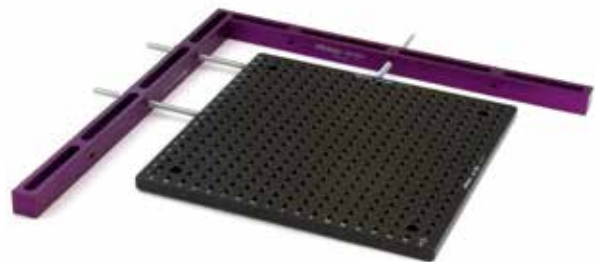

Base plate not included in scope of delivery

The simplest way to positioning and holding fixtures on the CMM, fits for nearly all CMM on the market!

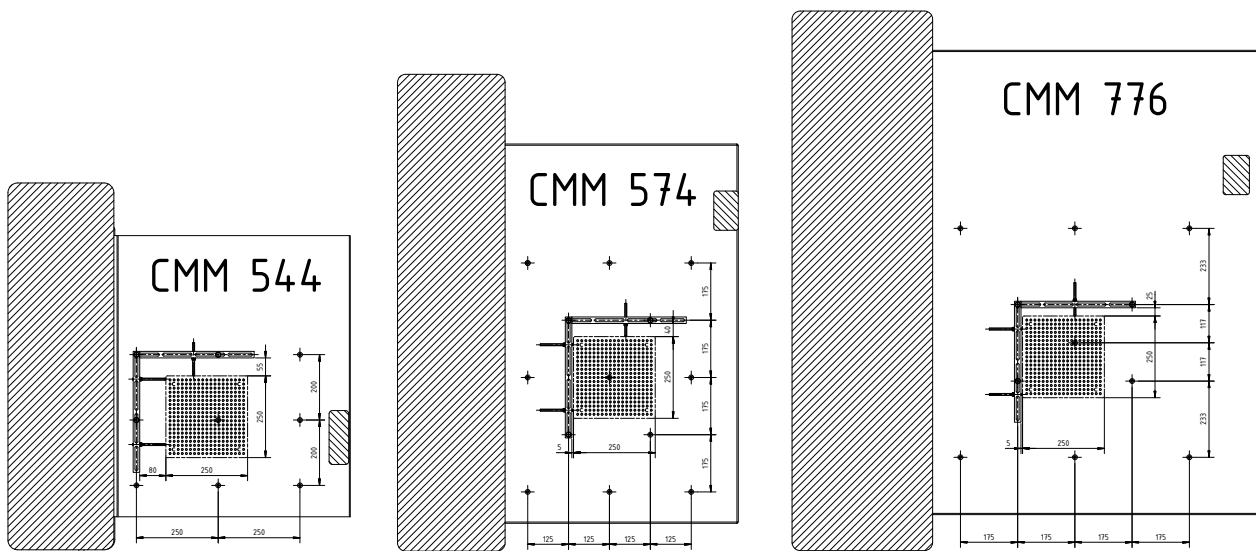

# eco-fix rail KIT L

Typ hier uw tekst

Typ hier uw tekst



Part No. K551198

Part No.	Qty.	Part name
K551195	2	eco-fix positioning rail L=550mm
K580709	3	Threaded spindle M6
K550122	3	Flat washer D= 6,4
K900868	4	Washer
K550562	3	Hexnut M6
K904397	4	Lens head screw Din ULS HLG

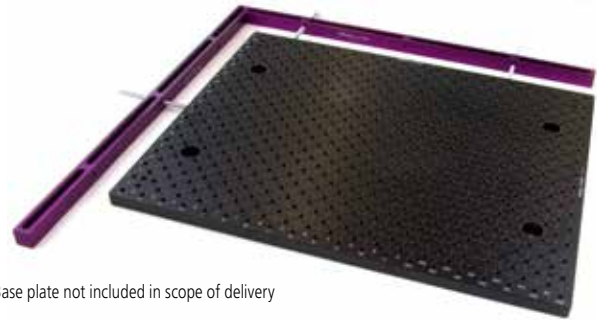

Base plate not included in scope of delivery

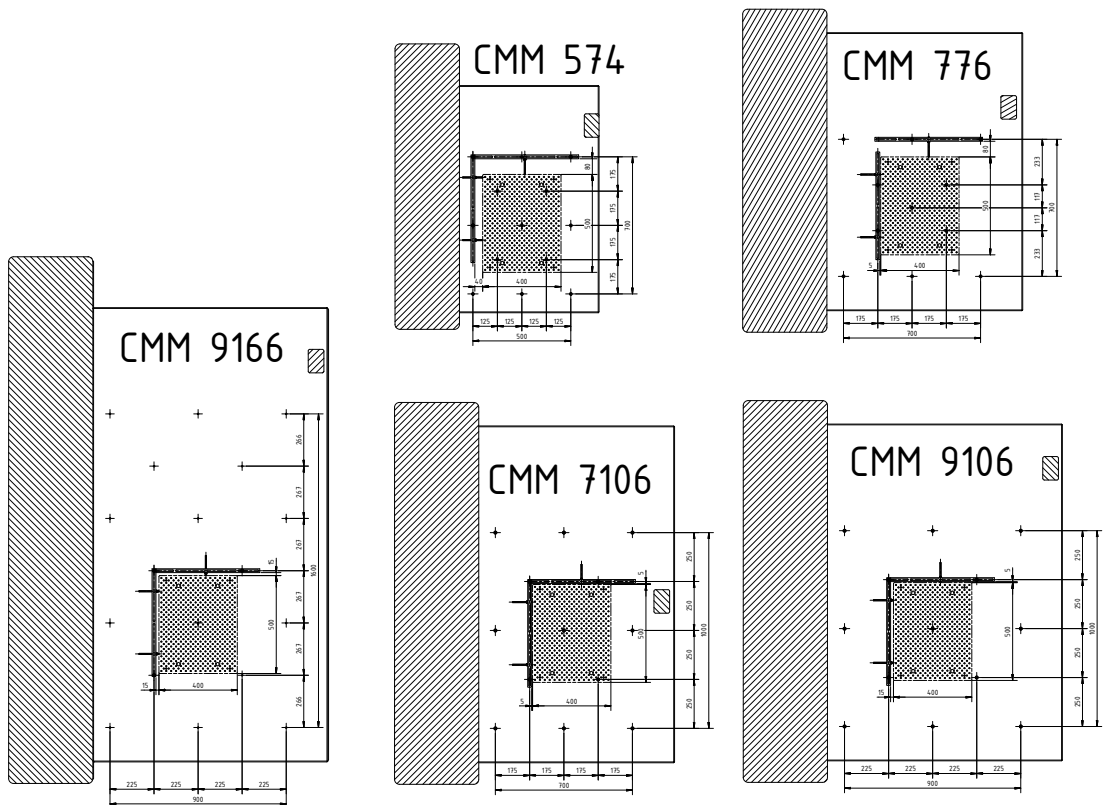



# Mitutoyo pallet receiver system

Typ hier uw tekst  
toolingpartners.com

Typ hier uw tekst

The sophisticated new Mitutoyo manual pallet receiver system significantly speeds up measuring on coordinate measuring machines as well as on form and vision measuring devices. Workpieces can be exchanged rapidly with the new system.

The pallet system comprises the tried and tested Mitutoyo eco-fix system, a base plate with two handles and three semi-spheres on the bottom. The latter help the measuring staff with quickly and precisely positioning the pallet on the receiver frame fixed to the measuring machine – in just one step. This way, fine-adjusting of the position is a thing of the past.

During the measuring process another workpiece can be positioned on a second, identically equipped pallet and placed on the machine as soon as the first workpiece has been measured. This not only guarantees very quick measurement and – as a consequence – a high workpiece throughput but also top process safety.

The new pallet receiver system even facilitates semi-automatic serial measurements if combined with a barcode that identifies the workpiece and starts the corresponding measurement program. This makes work for the measurement staff extremely easy: place the pallet onto the measuring machine and scan the barcode for initiating the measuring process. This renders long clicking through menus and folders for starting the measuring unnecessary.

Mitutoyo offers a rack system that can hold up to six pallets that can be placed close to the CMM. It will hold the Fixtures prepared for the next measurement. For perfect tidiness in the measuring room and stowing away pallets that are currently not in use Mitutoyo offers customized racks system that can hold all of your fixture pallets, even when equipped with fixtures and workpieces. That way, you can build up a fixture archive for all your parts with a repetitive measurement schedule.

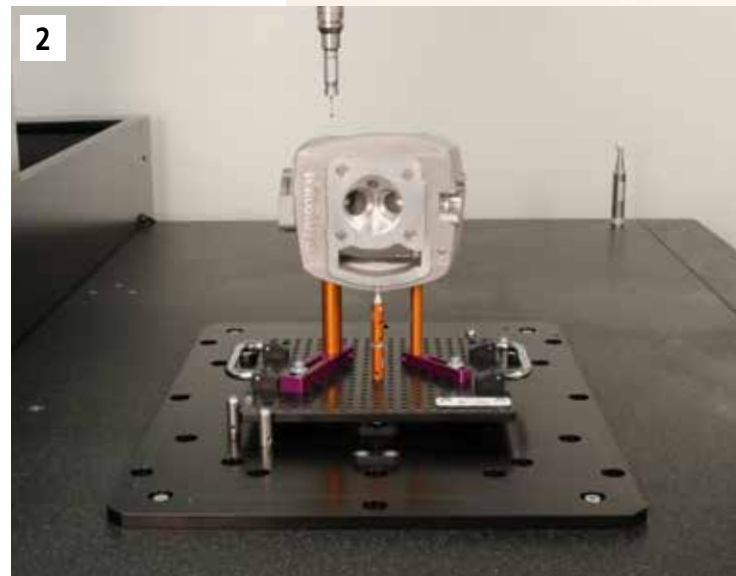



# MITUTOYO pallet receiver system



The affordable new manual pallet receiver system is perfectly suitable where workpiece throughput shall be boosted although fully automated solutions are not feasible or beyond budget.

- Easy, precise and fast repositioning
- Enhances semi-automatic serial CMM measurement
- Significantly higher measurement throughput
- Stowing rack for perfect workshop tidiness.

**In combination with the well-known eco-fix system, you get the most out of CMM measurement.**

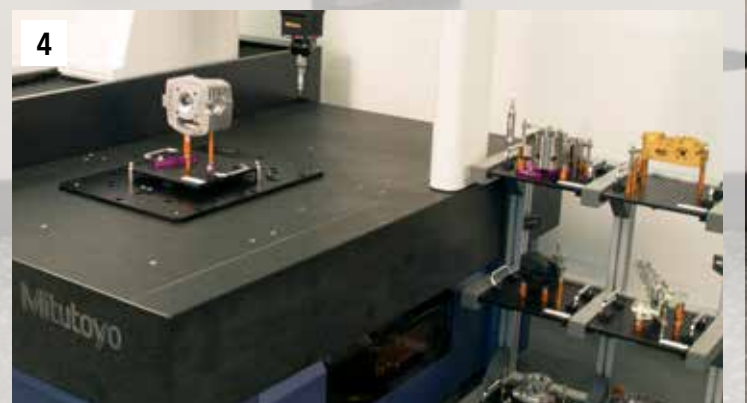

# eco-fix pallet receiver Kit S



Typ hier uw tekst

## Part No. K551218

Part No.	Qty.	Part name
K551024	1	Location pin $\varnothing$ 12 mm x 13 mm
K551025	1	Location pin $\varnothing$ 12 mm x 25 mm
K551026	1	Location pin $\varnothing$ 12 mm x 50 mm
K551027	1	Location pin $\varnothing$ 12 mm x 100 mm
K551028	1	Location pin $\varnothing$ 20 mm x 13 mm
K551029	1	Location pin $\varnothing$ 20 mm x 25 mm
K551030	1	Location pin $\varnothing$ 20 mm x 50 mm
K551031	1	Location pin $\varnothing$ 20 mm x 100 mm
K551032	2	Clamping claw eco-fix
K551034	1	Base plate 250 mm x 250 mm
K551035	1	Receiver bracket small
K551036	1	Receiver bracket large
K551040	1	Adjustable location pin $\varnothing$ 20 mm
K551041	1	Adjustable location pin $\varnothing$ 12 mm
K551042	3	Location pin $\varnothing$ 12 mm with bore 6 mm
K551044	1	Receiver bracket L = 90; $\varnothing$ 12 mm
K551045	1	Receiver bracket L = 120; $\varnothing$ 20 mm
K550716	2	Straight pin with thread
K550279	1	Spring clip, $\varnothing$ 8 mm, L = 60 mm
K550554	1	Spring clip, $\varnothing$ 8 mm, L = 40 mm
K550262	2	V-block mini
K550261	2	Cone receiver mini
K550250	1	Stopper element mini
K550247	1	Back square mini
K550888	2	Straight pin $\varnothing$ 6 mm x 20 mm
K550889	2	Straight pin $\varnothing$ 6 mm x 30 mm
K550890	2	Straight pin $\varnothing$ 6 mm x 40 mm
K551046	1	Slotted nut for receiver bracket h = 12 mm
K551047	1	Slotted nut for receiver bracket h = 15 mm
K551050	1	Allen key 2 mm
K551051	1	Allen key 3 mm
K551052	1	Allen key 4 mm
K551053	1	Allen key 5 mm
K551054	1	Double open-ended spanner SW10
K550591	8	Washer $\varnothing$ 6.4 mm x $\varnothing$ 17 mm
K550110	6	Cylinder head screw M6 x 20
K550563	2	Cylinder head screw M6 x 25
	59	

Part No.	Qty.	Part name
K551220	1	Loading receiver plate for manual eco-fix loading system
K551221	3	Ballscrew $\varnothing$ 10
K551199	1	Pair of handles for Eco-fix base plates



# eco-fix pallet receiver Kit L

Typ hier uw tekst

Typ hier uw tekst

Typ hier uw tekst



## Part No. K551219

Part No.	Qty.	Part name
K551024	2	Location pin ø 12 mm x 13 mm
K551025	2	Location pin ø 12 mm x 25 mm
K551026	2	Location pin ø 12 mm x 50 mm
K551027	2	Location pin ø 12 mm x 100 mm
K551028	2	Location pin ø 20 mm x 13 mm
K551029	2	Location pin ø 20 mm x 25 mm
K551030	2	Location pin ø 20 mm x 50 mm
K551031	2	Location pin ø 20 mm x 100 mm
K551032	3	Clamping claw eco-fix
K551033	1	Base plate 500 mm x 400 mm
K551035	2	Receiver bracket small
K551036	1	Receiver bracket large
K551040	2	Adjustable location pin ø 20 mm
K551041	2	Adjustable location pin ø 12 mm
K551042	3	Location pin ø 12 mm with bore 6 mm
K551043	3	Location pin ø 20 mm with bore 8 mm
K551044	1	Receiver bracket L = 90 mm, ø 12 mm
K551045	2	Receiver bracket L = 120 mm, ø 20 mm
K550716	3	Straight pin with thread
K550279	2	Spring clip, ø 8 mm, L = 60 mm
K550554	1	Spring clip, ø 8 mm, L = 40 mm
K550262	2	V-Block mini
K550261	2	Cone receiver mini
K550250	1	Stopper element mini
K550247	1	Back square mini
K550058	2	V-block
K550365	2	Cone Receiver
K550982	1	Stopper element
K550248	1	Back square
K550888	2	Straight pin ø 6 mm x 20 mm
K550889	2	Straight pin ø 6 mm x 30 mm
K550890	2	Straight pin ø 6 mm x 40 mm
K550000	2	Straight pin ø 8 mm x 30 mm
K550001	2	Straight pin ø 8 mm x 50 mm
K550002	2	Straight pin ø 8 mm x 65 mm
K551046	1	Slotted nut for receiver bracket h = 12 mm
K551047	2	Slotted nut for receiver bracket h = 15 mm
K551050	1	Allen key 2 mm
K551051	1	Allen key 3 mm
K551052	1	Allen key 4 mm
K551053	1	Allen key 5 mm
K551054	1	Double open-ended spanner SW10
K550591	12	Washer D = 6.4 mm / D = 17 mm
K550110	6	Cylinder head screw M6 x 20 mm
K550563	6	Cylinder head screw M6 x 25 mm
	98	

Part No.	Qty.	Part name
K551220	1	Loading receiver plate for manual eco-fix loading system
K551221	3	Ballscrew ø10
K551199	1	Pair of handles for Eco-fix base plates

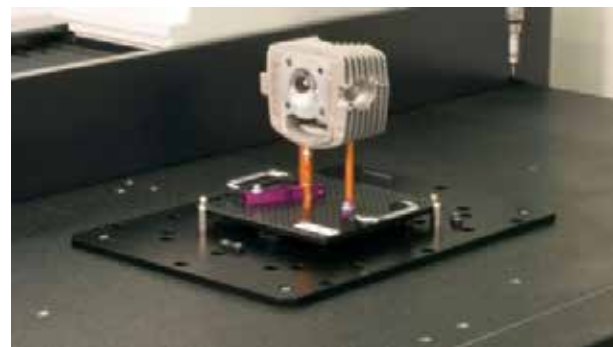

# Extension kits for pallet receiver



Part No. K551216

## Set of handles for Eco-fix base plates and Ballscrew

Part No.	Qty.	Part name
K551199	1	Pair of handles for Eco-fix base plates
K551221	1	Ballscrew set (3pcs.) for manual eco-fix loading system
	2	



Part No. K551217

## Loading receiver plate set for manual eco-fix loading system

Part No.	Qty.	Part name
K551220	1	Loading receiver plate for manual eco-fix loading system
K551199	1	Pair of handles for Eco-fix base plates
K551221	1	Ballscrew set (3pcs.) for manual eco-fix loading system
	3	



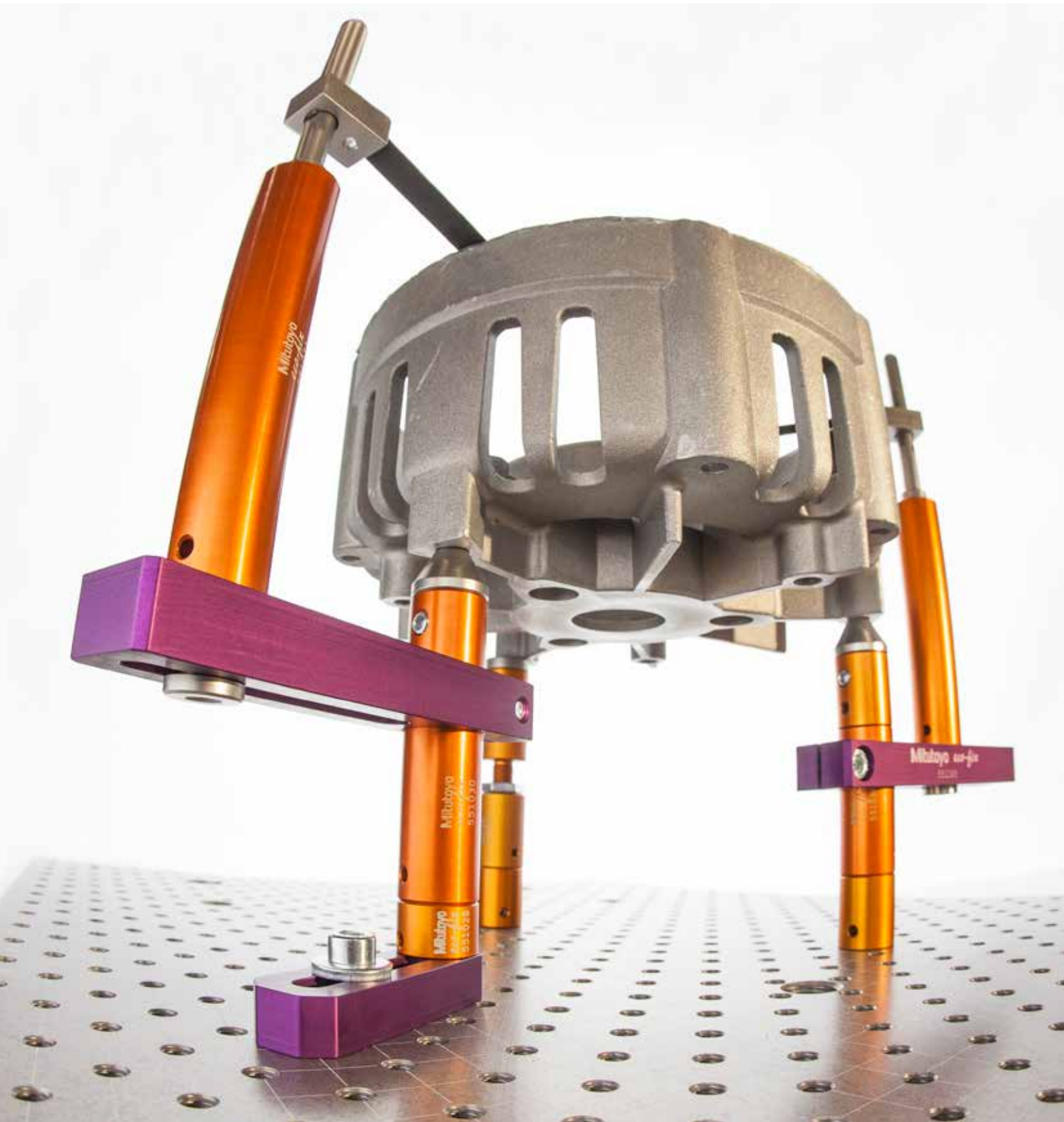

# Racks



Rack for two pallets  
includes fixing materials  
Part No. K543810



Rack for four pallets  
includes fixing materials  
Part No. K543811

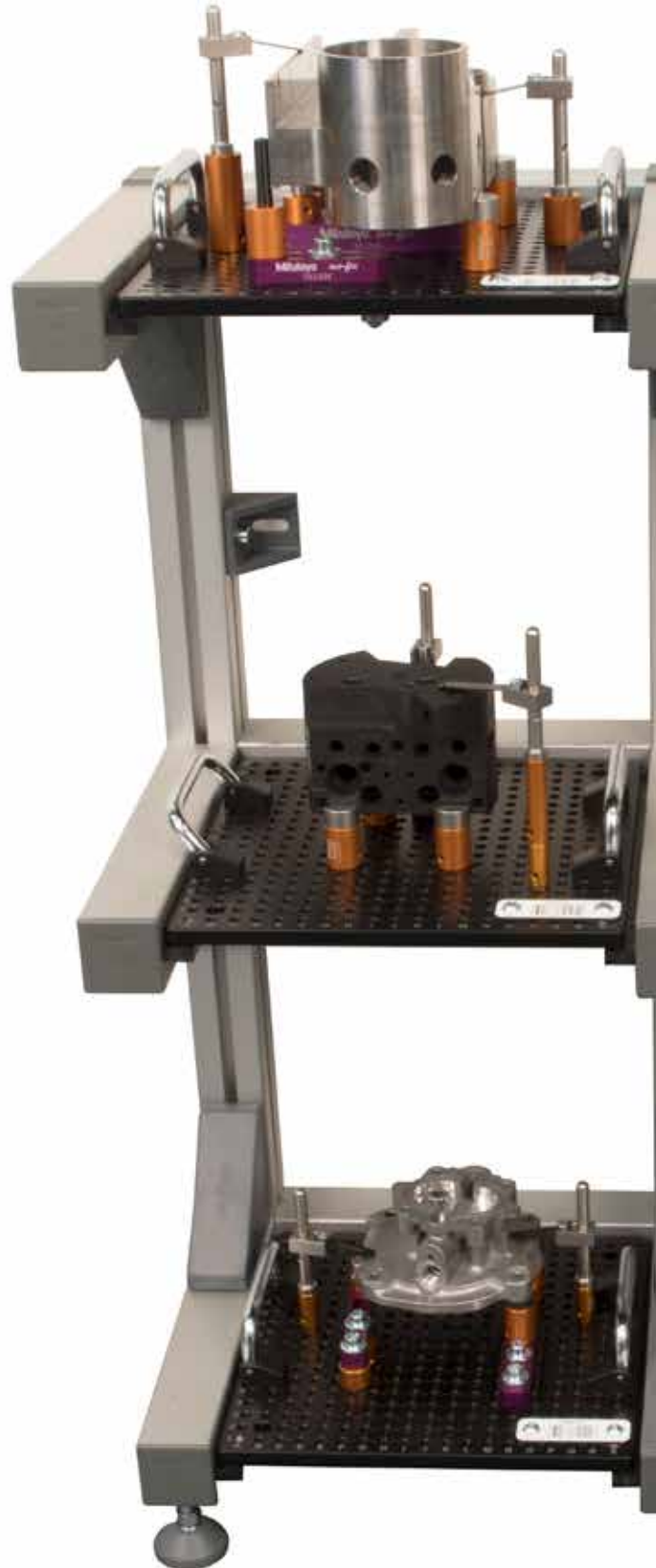



Rack for six pallets  
includes fixing materials  
Part No. K543812

Extension kit from two to four pallets  
Part No. K543813



Upgrade kit from four to six pallets  
Part No. K543813



# System Components

**Base plate eco-fix  
500 mm x 400 mm**

Made of hard-anodised aluminium, with connecting thread M6, grid distance 12.5 mm / 25 mm

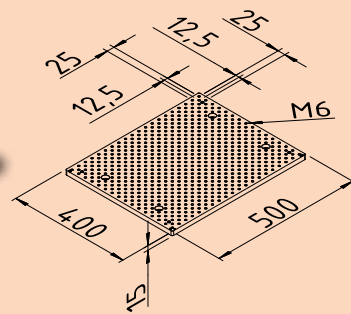
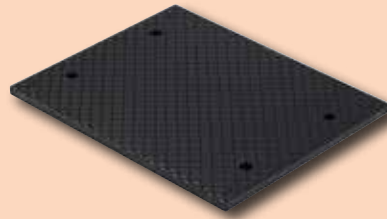

**Part No.: K551533**  
Weight 7600 g

**Base plate eco-fix  
250 mm x 250 mm**

Made of hard-anodised aluminium, with connecting thread M6, grid distance 12.5 mm

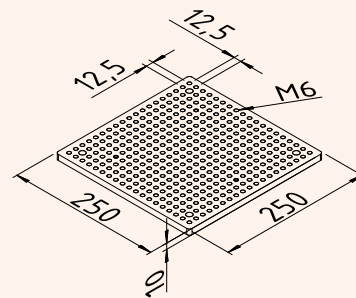
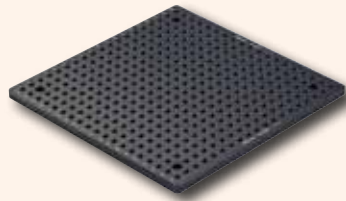

**Part No.: K551034**  
Weight 1500 g

**Base plate eco-fix  
250 mm x 125 mm**

Made of hard-anodised aluminium, with connecting thread M6, grid distance 12.5 mm

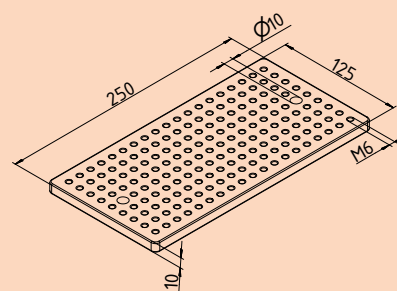
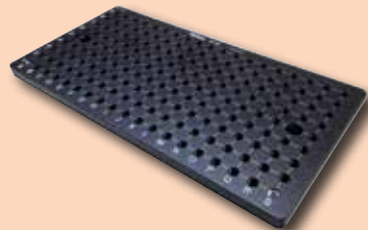

**Part No.: K551226**  
Weight 750 g

**Base plate eco-fix  
125 mm x 125 mm**

Made of hard-anodised aluminium, with connecting thread M6, grid distance 12.5 mm

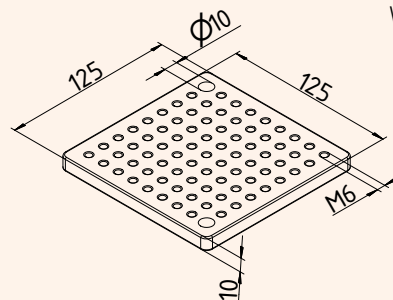

**Part No.: K551306**  
Weight 375 g



# SYSTEM COMPONENTS

## Base plate eco- and opti-fix for contour illumination, 250x250mm

Made of hard-anodised aluminium, with connecting thread M6, grid distance 12.5 mm, contour illumination glass

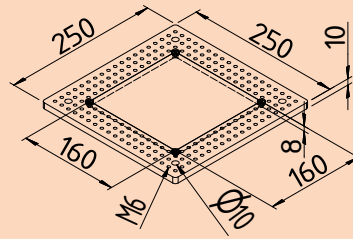
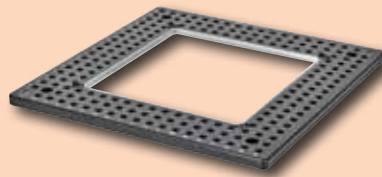

**Part No.:** K551215  
Weight 1120 g

## Adaptor plate ø 150 mm

Made of hard-anodised aluminium, to adapt holding fixtures on Mitutoyo turn-tables for roughness and form measuring machines. Delivered including 3 slotted nuts and mounting parts

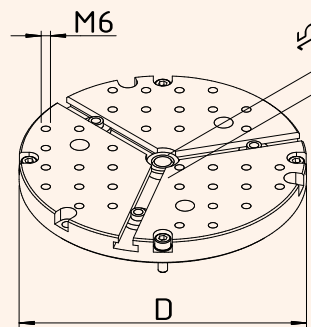

**Part No.:** K551038  
Adaptor plate 150 mm for Mitutoyo turn-tables RA114/6 and RA1500

Weight 720 g

## Adaptor plate ø 200 mm

Made of hard-anodised aluminium, to adapt holding fixtures on Mitutoyo turn-tables for roughness and form measuring machines. Delivered including 3 slotted nuts and mounting parts

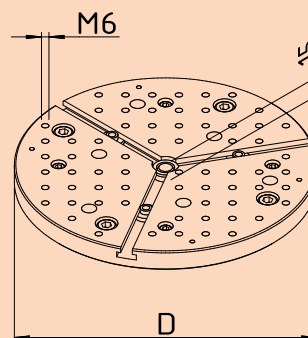
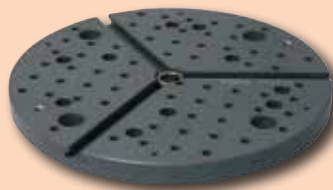

**Part No.:** K551039  
Adaptor plate 200 mm for Mitutoyo turn-tables 12AAD975 and RA2000DS/DH

Weight 1300 g

## Loading receiver plate for manual eco-fix loading system

With pallet positioning brackets

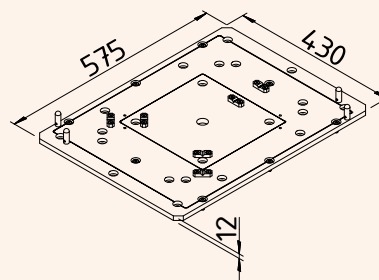

**Part No.:** K551220  
Weight 8070 g

# System Components

## Adapter plate

Made of hard-anodised aluminium, adapter plate to eco-fix base plates and RST-Profile for build up column

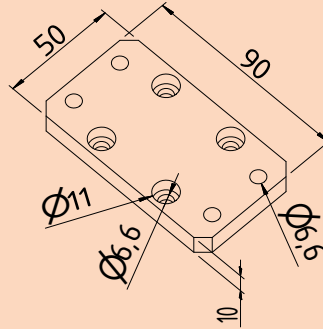

**Part No.: K551213**  
Weight 110 g

## Build up column 255mm

Made of hard-anodised aluminium, with connecting threads M6

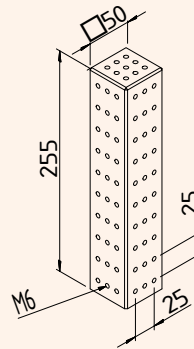

**Part No.: K551212**  
Weight 1600 g

## Clamping claw eco-fix

For fixing of base plates on the measuring table

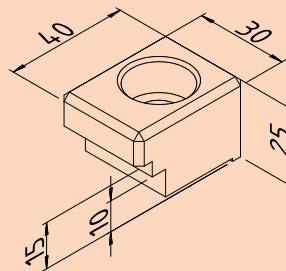
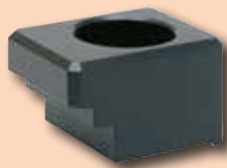

**Part No.: K551032**  
Weight 27 g

# SYSTEM COMPONENTS

## Ballscrew set (3pcs.) for manual eco-fix loading system

Positioning spheres with  
connecting thread M6

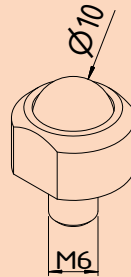

Part No.: K551221

Weight 30 g

## Pair of handles for Eco-fix base plates

Handles with connecting  
screws and screw covers

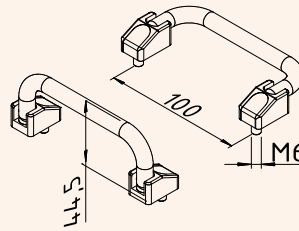

Part No.: K551199

Weight 300 g

## Receiving bracket L = 120 mm, Ø 20 mm

For mounting on location pins,  
to reach any position, e.g.  
for positioning of clamping  
elements directly on receiving  
points

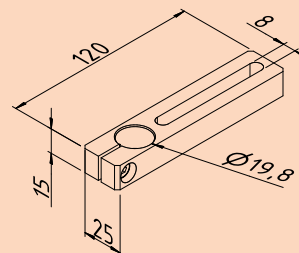

Part No.: K551045

Weight 88 g

## Receiving bracket L = 90 mm, Ø 12 mm

For mounting on location pins,  
to reach any position, e.g.  
for positioning of clamping  
elements directly on receiving  
points

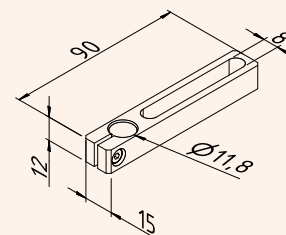

Part No.: K551044

Weight 26 g

# System Components

## Receiver bracket large

To reach any receiving position between the connecting threads

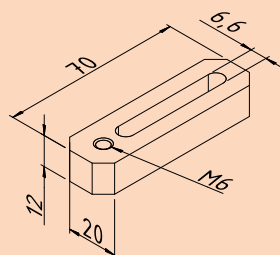

Part No.: K551036

Weight 34 g

## Receiver bracket small

To reach any receiving position between the connecting threads

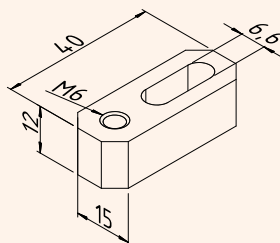

Part No.: K551035

Weight 14 g

## Joint eco-fix ø 20 mm

Joint for connecting dial gauges and indicators

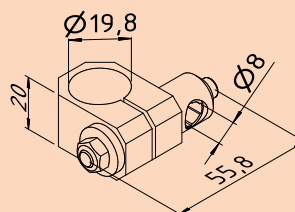

Part No.: K551203

Weight 60 g

## Joint eco-fix ø 12 mm

Joint for connecting dial gauges and indicators

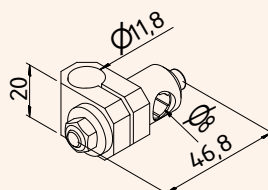

Part No.: K551204

Weight 60 g

## Slotted nut h = 15 mm

Appropriate with receiving bracket 551045, for mounting e.g. location pins on the receiving bracket, to reach any position in space, e.g. for positioning of clamping elements directly on receiving points

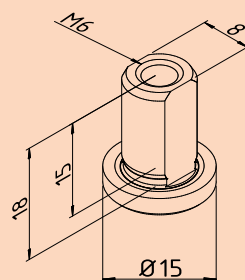

Part No.: K551047

Weight 9 g



# SYSTEM COMPONENTS

## Slotted nut h = 12 mm

Appropriate with receiving bracket 551044, for mounting e.g. location pins on the receiving bracket, to reach any position in space, e.g. for positioning of clamping elements directly on receiving points

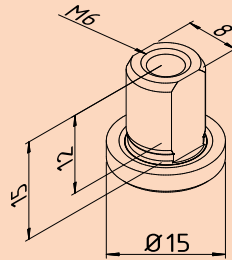

Part No.: K551046

Weight 8 g

## Location pin Ø 20 mm

For the adjustment of the required height of the fixture

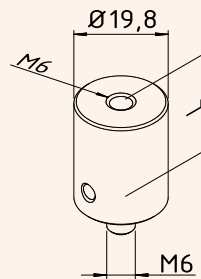

Part No.:

K551028 L = 13 mm

K551029 L = 25 mm

K551030 L = 50 mm

K551031 L = 100 mm

Weight 10 g

Weight 19 g

Weight 39 g

Weight 83 g

## Location pin Ø 12 mm

For the adjustment of the required height of the fixture

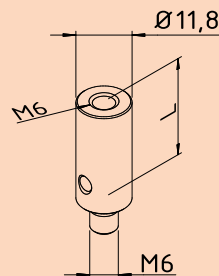

Part No.:

K551024 L = 13 mm

K551025 L = 25 mm

K551026 L = 50 mm

K551027 L = 100 mm

Weight 3 g

Weight 6 g

Weight 13 g

Weight 27 g

## Location pin Ø 20 mm

With bore Ø 8 mm for connecting of elements with 6 mm connecting pin

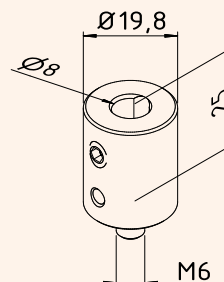

Part No.: K551043

Weight 19 g

## Location pin Ø 12 mm

With bore Ø 6 mm for connecting of elements with 6 mm connecting pin

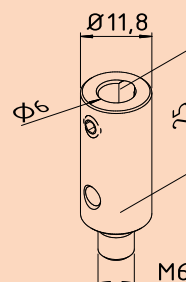

Part No.: K551042

Weight 7 g

# System Components

## Adjustable location pin ø 20 mm

For the adjustment of the required height of receiving positions

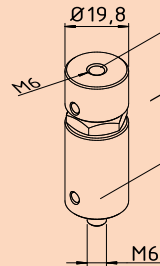

Part No.: K551040

Weight 44 g

## Adjustable location pin ø 12 mm

For the adjustment of the required height of receiving positions

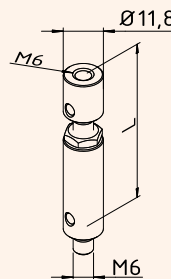

Part No.: K551041

Weight 15 g

## Turn-swivel joint ø 20 mm

To reach any position in space

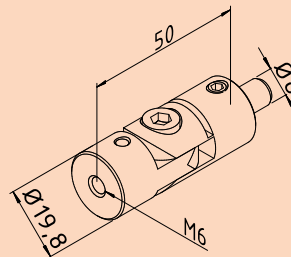

Part No.: K551076

Weight 49 g

## Turn-swivel joint ø 12 mm

To create free positions in space

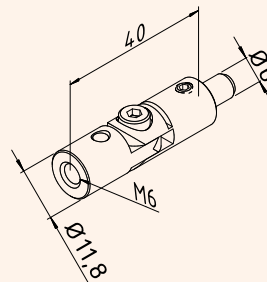

Part No.: K551075

Weight 15 g

## Magnetic receiver ø 20 mm

For quick and easy clamping of workpieces

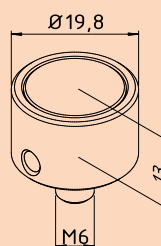

Part No.: K551074

Weight 15 g

# SYSTEM COMPONENTS

## Magnetic receiver ø 12 mm

For quick and easy clamping  
of workpieces

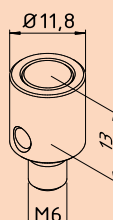

**Part No.: K551073**  
Weight 5 g

## Adaptor pin eco-repro ø 20 mm

For connecting the eco-fix sys-  
tems on repro-fix base  
plates or profiles

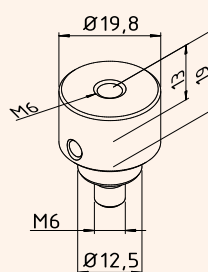

**Part No.: K551067**  
Stainless steel  
Weight 35 g

## Adaptor pin eco-repro ø 12 mm

For connecting the eco-fix sys-  
tems on repro-fix base  
plates or profiles

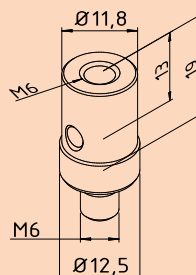

**Part No.: K551066**  
Stainless steel  
Weight 20 g

## Adaption eco- to repro-fix ø 12 mm

For connecting the eco-fix  
components on repro-fix base  
plates or profiles

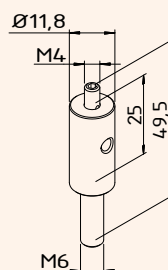

**Part No.: K551211**  
Weight 15 g

# System Components

## Adaption eco- to opti-fix Ø6mm

For connecting the eco-fix components to opti-fix components

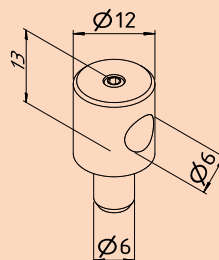

**Part No.:** K551189  
Weight 15 g

## Adapting bolt for master ball

For connecting master ball to eco-fix base plates

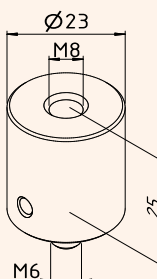

**Part No.:** K551153  
Weight 76 g

## Adapting bolt M6 M8

For connecting eco-fix components to M8 threads

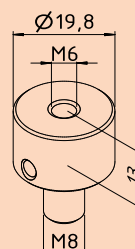

**Part No.:** K551065  
Weight 30 g

## Flat top Ø 20 mm

For direct workpiece support

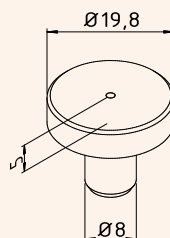

**Part No.:** K551070  
Stainless steel  
Weight 17 g

## Flat top Ø 12 mm

For direct workpiece support

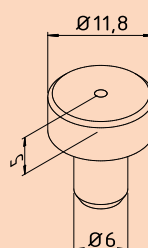

**Part No.:** K551069  
Stainless steel  
Weight 6 g



# SYSTEM COMPONENTS

## SYSTEM COMPONENTS

### Stopper element

For receiving a workpiece in a defined position

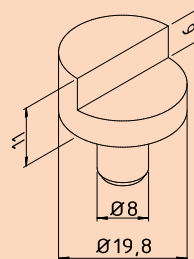

Part No.: K550982

Weight 25 g

### Stopper element mini

For receiving a workpiece in a defined position

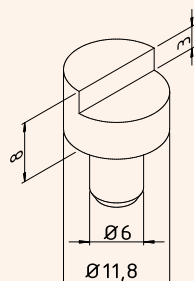

Part No.: K550250

Weight 8 g

### Back square

For receiving a workpiece in a defined position in XYZ

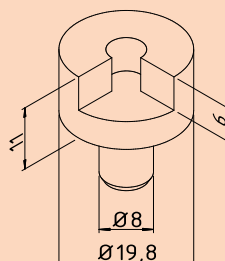

Part No.: K550248

Weight 27 g

### Back square mini

For receiving a workpiece in a defined position in XYZ

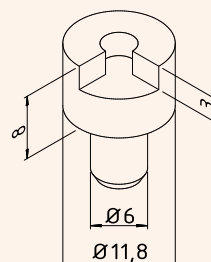

Part No.: K550247

Weight 8 g

### V-block

For receiving of e.g. rotationally symmetrical parts in a defined position

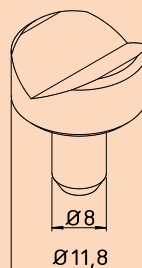

Part No.: K550058

Weight 24 g

# System Components

## V-block mini

For receiving of e.g. rotationally symmetrical parts in a defined position

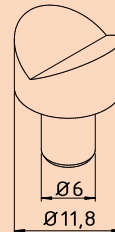

Part No.: K550262

Weight 7 g

## Sphere top ø 20 mm

For direct workpiece support on non regular surfaces

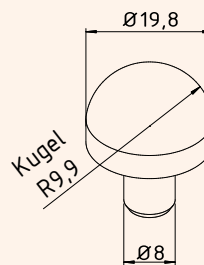

Part No.: K551072

Stainless steel  
Weight 28 g

## Sphere top ø 12 mm

For direct workpiece support on non regular surfaces

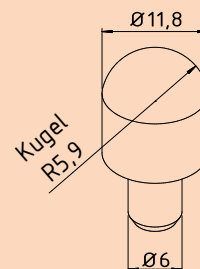

Part No.: K551071

Stainless steel  
Weight 11 g

## Cone receiver

For receiving parts in bores or centerings etc.

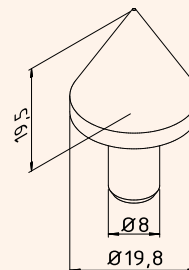

Part No.: K550365

Weight 26 g

## Cone receiver mini

For receiving parts in bores or centerings etc.

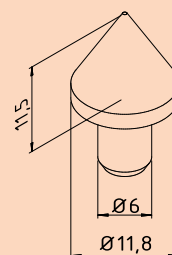

Part No.: K550261

Weight 6 g

# SYSTEM COMPONENTS

## Straight pin mini

As stopper element



### Part No.:

**K550888** L = 20 mm

**K550889** L = 30 mm

**K550890** L = 40 mm

Weight 4 g

Weight 7 g

Weight 12 g

## Straight pin

As stopper element



### Part No.:

**K550000** L = 30 mm

**K550001** L = 50 mm

**K550002** L = 65 mm

**K550003** L = 85 mm

Weight 12 g

Weight 19 g

Weight 25 g

Weight 30 g

## Spring clip

For simple and quick clamping of parts

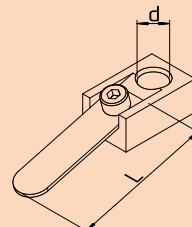

### Part No.:

**K550554** d = 8 mm L = 40 mm

**K550279** d = 8 mm L = 60 mm

**K550278** d = 6 mm L = 40 mm

**K550292** d = 6 mm L = 60 mm

Weight 25 g

Weight 27 g

Weight 27 g

Weight 29 g

## Straight pin with thread

For receiving of spring clip, d = 8 mm, directly on base plates or assembly elements

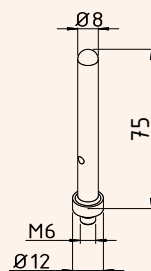

### Part No.: K550716

Weight 32 g

## Vice

Clamping jaws equipped with prisms and surfaces can be changed and combined. By reason of the two-way double function, a very flexible fixation is possible. Connecting threads on the top of the jaws, allows e.g. in combination with pins the internal fixation of e.g. turning workpieces. Clamping range 0-68 mm.

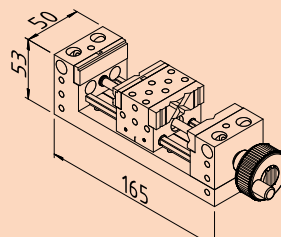
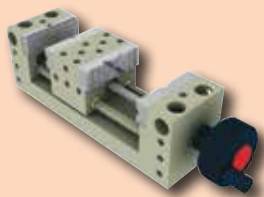

### Part No.: K551078

Weight 920 g

# Mitutoyo car-fix

VARI-FIX+RST-PROFIL

## The Mitutoyo car-fix series comprises of two flexible and freely combinable systems in their own right:

### vari-fix

The novel clamping system vari-fix is bringing in three standard models with adjustment heights of the columns of 375 - 575 mm, 500 - 825 mm and 625 - 1075 mm. The system can also be customised to different adjustment heights on request.

The bases of the entire device are top-frame profile rails that can be mounted directly on the measuring table of the coordinate measuring machine. Alternatively, the S-profile from Mitutoyo can be used, or the pillars with base plates can be mounted on the CMM table. Mitutoyo vari-fix allows free and unrestricted orientation of the workpiece in any desired pick-up position. The workpiece is being fastened to any of a number of columns arranged along base rails. The individual columns are height-adjustable, and a swivel joint at the upper end serves as a pick up element for the workpiece. The joint allows 360 degrees of rotation about the axis of the column and has a swivel range of +/- 90 degrees. The positioning can be finely adjusted along the X-, Y- and Z-axes by +/- 2.5 millimetres. Thanks to the extremely flexible combination of rotation and tilt, any spatial angle can be achieved. Vari-fix columns are made to order and can be changed according to customer request.

### RST-profile

For the first time the new RST-profile from Mitutoyo combines in one profile the advantages of three different kinds of profiles for fixture construction.

Dovetail profile

- Flexible repositioning with slider elements for rapid and cost effective changes of fixture points.

Grid profile

- Benefit from a fixed 50mm positioning grid for the reproducible addition of features.

T-nut profile

- Additions can be added and freely positioned in the t-nut profile
- Can be combined with all kinds of profiles and add-on parts, even from third parties.

The matt-black surface suppresses reflections, which is especially advantageous for optical measuring systems. All these features of the RST profile contribute to the minimisation of material provision in modular fixture construction, which significantly reduces the costs for storage and shortens assembly times. RST-profiles are compatible with the tried & tested Mitutoyo profiles and are ideal for combining with the vari-fix clamping columns.





# MITUTOYO CAR-FIX



# Mitutoyo vari-fix adjustable columns

**Adjustable build up column  
vari-fix S (375-575mm)**  
Part No. K542241

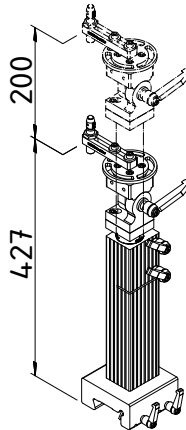

Weight 4200 g  
adjustable length range 375mm - 575mm  
200mm

**Adjustable build up column  
vari-fix M (500-825mm)**  
Part No. K542242

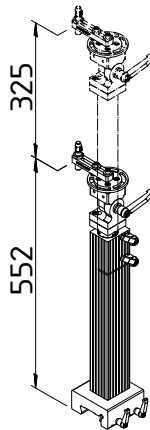

Weight 5000 g  
adjustable length range 500mm - 825mm  
325mm

**Adjustable build up column  
vari-fix L (625-1075mm)**  
Part No. K542243

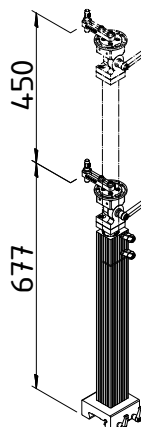

Weight 5800 g  
adjustable length range 625mm - 1075mm  
450mm

vari-fix always is custom made, tailored to the needs of the customer!  
Accessories and various versions available on request.

# Mitutoyo RST



Part No. K551109



Part No. K551177

## Mitutoyo RST-profile

Code No.	Name	length L	weight g	info
K551107	RST-profile	200mm	780	anodized black
K551108	RST-profile	250mm	970	anodized black
K551109	RST-profile	400mm	1550	anodized black
K551110	RST-profile	500mm	1940	anodized black
K551111	RST-profile	750mm	2910	anodized black
K551112	RST-profile	1000mm	3880	anodized black
K551113	RST-profile	1250mm	4850	anodized black
K551155	RST-profile	1500mm	5990	anodized black
K551156	RST-profile	2000mm	7990	anodized black
K551114	RST-profile	2500mm	9690	anodized black

## Mitutoyo RST-profile frame

Code No.	Name	length L	weight g	info
K551176	RST-profile	250mm	970	anodized black
K551177	RST-profile	500mm	1940	anodized black
K551178	RST-profile	750mm	2910	anodized black
K551179	RST-profile	1000mm	3880	anodized black
K551180	RST-profile	1250mm	4850	anodized black
K551181	RST-profile	1500mm	5990	anodized black
K551182	RST-profile	2000mm	7990	anodized black
K551185	RST-profile	2500mm	10990	anodized black

# SYSTEM COMPONENTS

**Slider element for profile connection RST and screw**

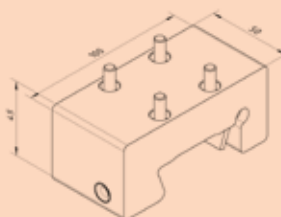

**Part No.: K551117**  
Weight 490 g

**Slider element M6**  
anodized black

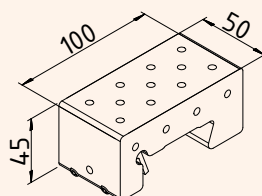

**Part No.: K550957**  
Weight 450g

**Slider element dovetail**  
anodized black

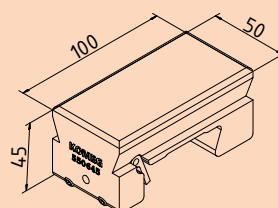

**Part No.: K550645**  
Weight 445g



# System Components

**Connector set**  
**RST-profile**  
anodized black

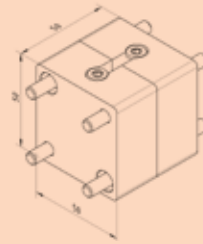

**Part No.: K551118**  
Weight 490 g

**Terminator 50 RST**  
anodized black

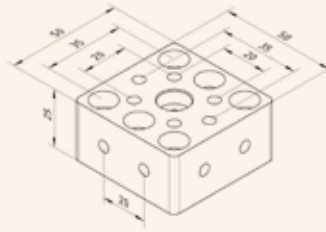

**Part No.: K551119**  
Weight 130 g

**Terminator 100 RST**  
anodized black

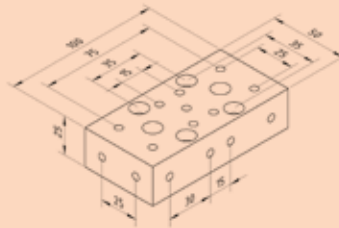

**Part No.: K551120**  
Weight 290 g

**Swivel plate RST**  
anodized black

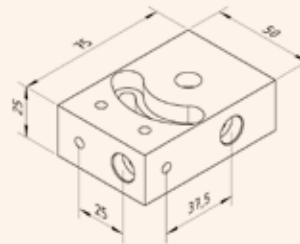

**Part No.: K551121**  
Weight 200 g

**Adjustment element**  
**RST XYZ**  
anodized black

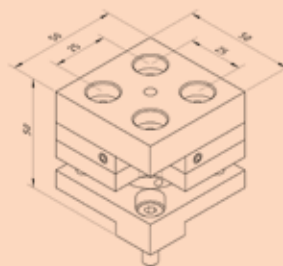

**Part No.: K551122**  
Weight 290 g



# SYSTEM COMPONENTS

**Cross connector RST**  
anodized black

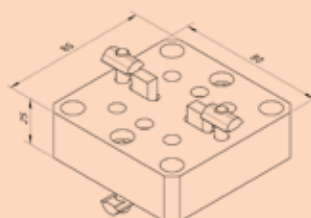

**Part No.: K551157**  
Weight 460 g

**T-slot nut M6**

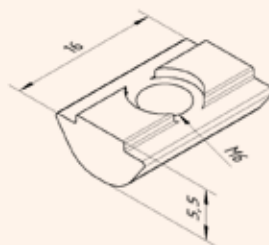

**Part No.: K551158**  
Weight 5 g

**Distance piece RST-profile**  
complete with T-slot nut and screw

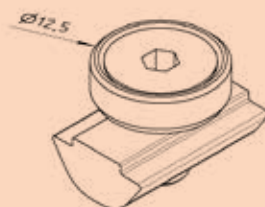

**Part No.: K551116**  
Weight 10 g

**Positioning pin RST**



**Part No.: K551136**  
Weight 5 g

**End cover RST-profile**  
plastics black

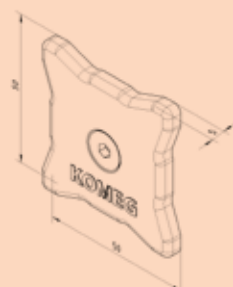

**Part No.: K551115**  
Weight 10 g

## Mitutoyo opti-fix

The modular clamping system opti-fix has been developed especially for optical coordinate measuring systems.

"Mitutoyo opti-fix" guarantees safe part fixture during measurement and consequently, ensures a permanent error-free transfer of measured values. This functional configuration makes also series measurements considerably easier.

In order to reduce disturbing reflections of lighting systems and ambient light to a minimum, all important construction elements are anodised in flat-black or matte finished.

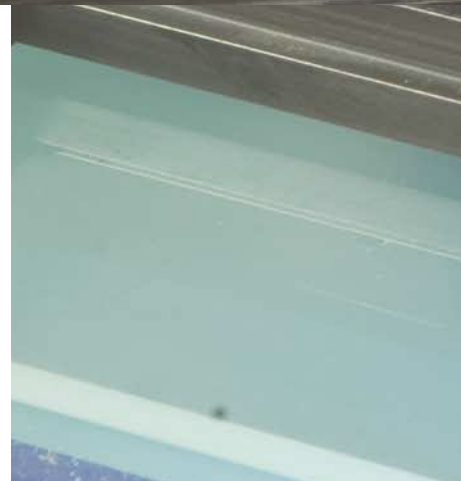
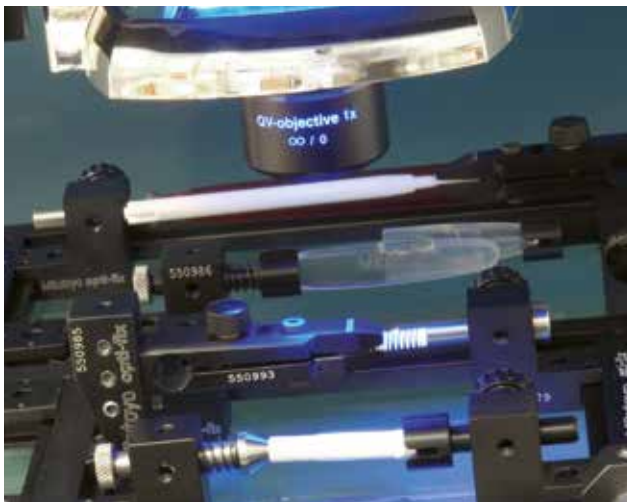
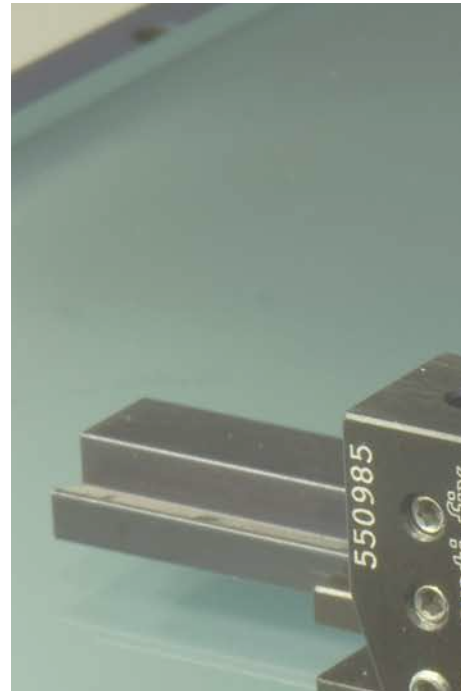

# MITUTOYO OPTI-FIX



For the mounting of the basic elements onto the CMM table there are different fastening types available.

- direct connection by means of vacuum clamping plates, independent from the existing connecting threads at the sides of the CMM table
- direct connection by means of fastening brackets using the connecting threads at the sides of the CMM table
- direct quick-connection for exchangeable modules by use of the innovative quick exchange system with magnetic retention force

The opti-fix system allows the quick and safe solution of very different tasks using only a few components. In case of measuring methods using reflected as well as transmitted light for measurement of cubic, rotationally symmetrical and especially flat workpieces, the use of opti-fix is a really practical solution.

Furthermore, the spring clips and centering pins of different design which are integrated in the system allow also tactile measuring. Mitutoyo opti-fix offers the user a large number of possibilities for part fixing, from clamping tweezers for miniature test specimens to precision vice for large parts.

## Mitutoyo opti-fix round

The innovative, newly developed Mitutoyo tool "Mitutoyo opti-fix round" completes the opti-fix types in the true sense of the word "the wheel comes full circle".

The circular design allows an infinitely variable adjustment of 360° in horizontal level as well as in space and additionally, the "pin fixing" at the sides ensures a user-friendly access to the workpiece.

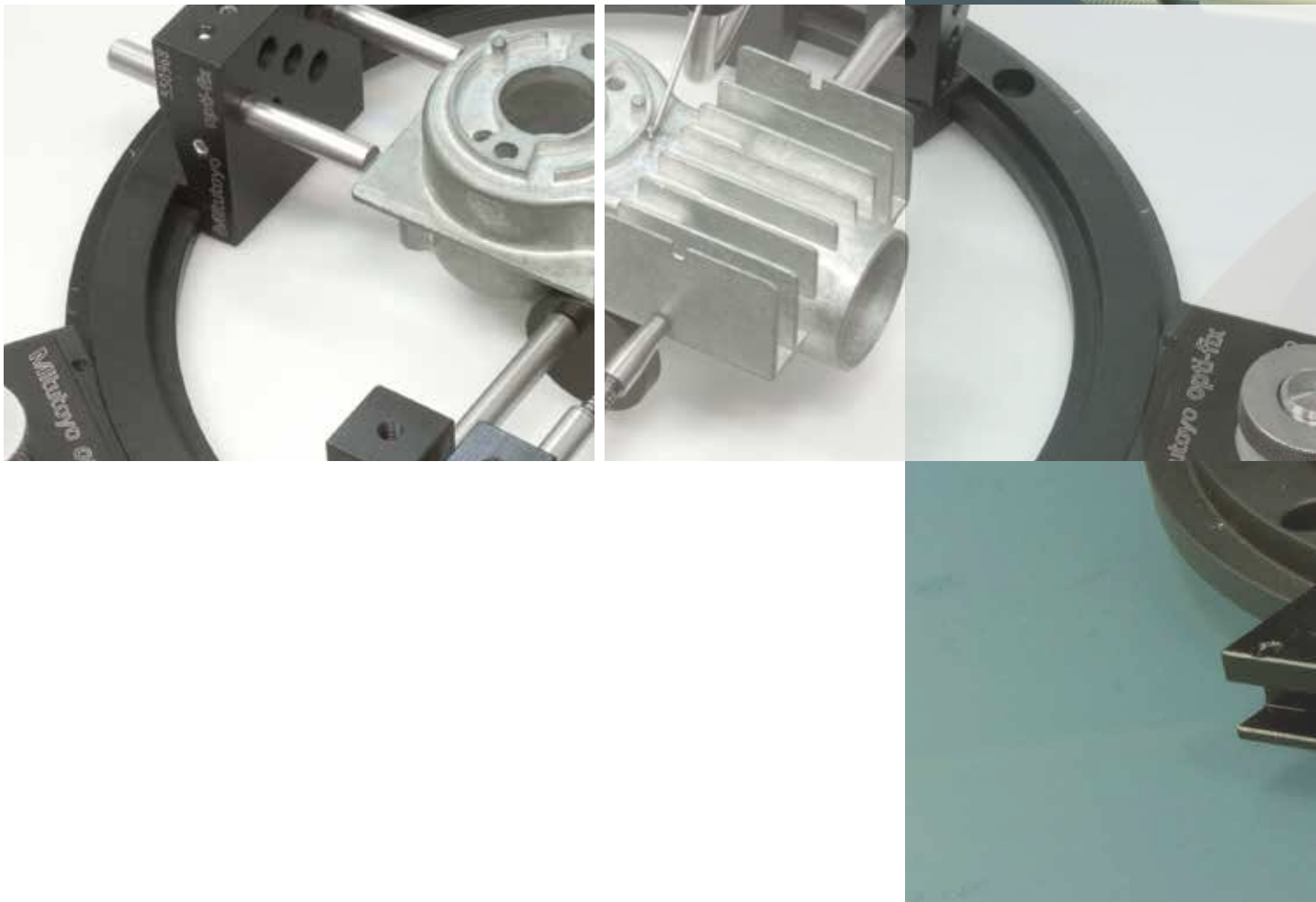



# MITUTOYO OPTI-FIX ROUND

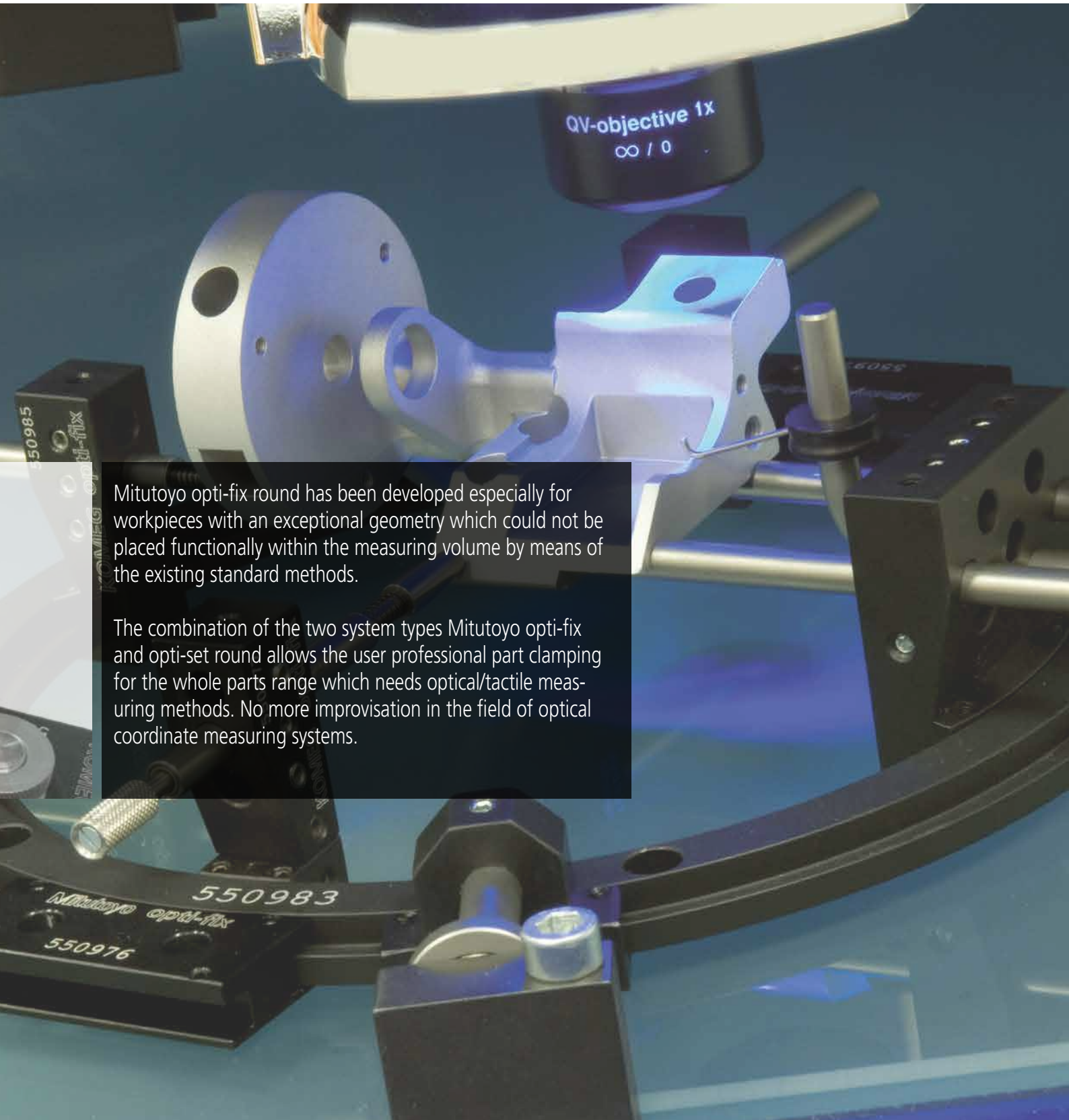

Mitutoyo opti-fix round has been developed especially for workpieces with an exceptional geometry which could not be placed functionally within the measuring volume by means of the existing standard methods.

The combination of the two system types Mitutoyo opti-fix and opti-set round allows the user professional part clamping for the whole parts range which needs optical/tactile measuring methods. No more improvisation in the field of optical coordinate measuring systems.

# Kit opti-set Start



Part No.: K551056

Smallest kit, consisting of 16 parts, for construction of a simple rail system with a length of 250 mm, for fixing parts with a simple part geometry. Fastening brackets, vacuum plates or magnetic holders for mounting the clamping system on the measuring machine, please order separately.

Part No.	Qty.	Part name
K550838	1	Connector clamp. profile rail; L = 100 mm
K550854	1	Clamping profile rail without slot L = 250 mm
K550842	1	Connector with connector grooves
K550853	3	Clamping fixture (with thread M4)
K550891	3	Straight pin for holding-down devices L = 30 mm
K550845	2	Toothed fixture L = 40 mm
K550843	1	Toothed fixture L = 100 mm
K550978	1	Spring clip 30° short
K550980	1	Spring clip 30° long
K550979	1	Spring clip 15° short
K551020	1	Allen key 1.5 mm
	16	

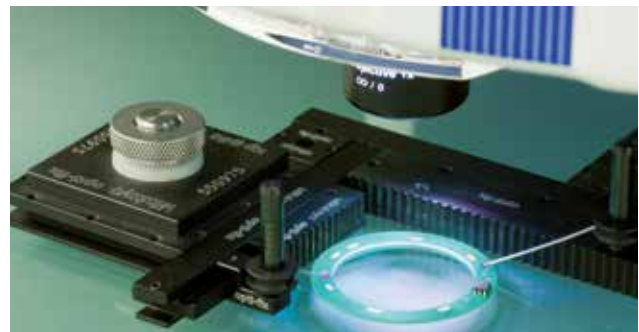

# Kit opti-set Basic



Part No.: K551057

Kit, consisting of 26 parts, for construction of a basic frame with the dimensions of 200 mm x 100 mm, for fixing parts with a simple geometry. Fastening brackets, vacuum plates or magnetic holders for mounting the clamping system on the measuring machine, please order separately.

Part No.	Qty.	Part name
K550838	3	Connector clamp. profile rail; L = 100 mm
K550857	2	Clamping profile rail without slot L = 200 mm
K550853	4	Clamping fixture (with thread M4)
K550891	4	Straight pin for holding-down devices L = 30 mm
K550845	4	Toothed fixture L = 40 mm
K550978	2	Spring clip 30° short
K550980	2	Spring clip 30° long
K550979	2	Spring clip 15° short
K550981	2	Spring clip 15° long
K551020	1	Allen key SW 1.5 mm
	26	

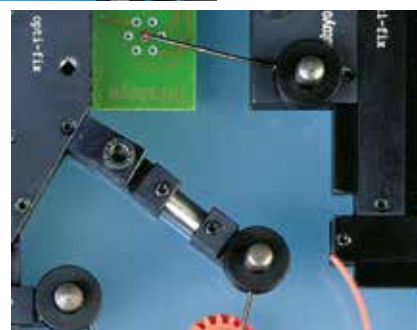

# Kit opti-set Rotation



Part No.: K551058

Kit, consisting of 23 parts, for construction of a basic frame with the dimensions of 250 mm x 200 mm, for fixing parts with rotationally symmetrical parts with and without centre holes. Fastening brackets, vacuum plates or magnetic holders for mounting the clamping system on the measuring machine, please order separately.

Part No.	Qty.	Part name
K550854	2	Clamping profile rail; L = 250 mm
K550859	2	Clamping profile rail; L = 200 mm
K550984	1	Clamping block GG
K550985	2	Clamping block GK
K550879	1	Tailstock with centre
K550986	1	Tailstock with spring-loaded centre
K551018	1	Prism 120° compl. with spring clip
K550972	1	Prismatic eccentric receiver
K550994	2	Centring receive
K550303	2	Receiver pin stepped 100 mm
K551062	2	Shaft 6 mm x 100 mm
K550842	4	Connector with connector grooves
K551020	1	Allen key 1.5 mm
K551021	1	Allen key 2 mm
	23	





# Kit opti-set Advanced



Part No.: K551059

Kit, consisting of 51 parts, for construction of a basic frame with the dimensions of 400 mm x 250 mm, for fixing parts with complex geometry. Fastening brackets, vacuum plates or magnetic holders for mounting the clamping system on the measuring machine, please order separately.

Part No.	Qty.	Part name
K550210	2	Clamping profile rail; L = 400 mm
K550836	3	Clamping profile rail; L = 250 mm
K550842	6	Connector with connector grooves
K550838	1	Clamping profile rail; L = 100 mm
K550984	2	Clamping block GG
K550985	1	Clamping block GK
K550213	1	Clamping block GKD, rotatable
K550858	1	Toothed fixture L = 100 mm
K550845	2	Toothed fixture L = 40 mm
K550970	1	Eccentric receiver
K550971	1	Prismatic receiver / locator
K550304	1	Receiver plane
K550301	3	Receiver pin stepped L = 60 mm
K550302	3	Receiver pin stepped L = 80 mm
K550303	3	Receiver pin stepped L = 100 mm
K550990	3	Rectangular receiver pin L = 50 mm
K550323	2	Rectangular receiver pin L = 25 mm
K551012	1	Spring-loaded clamping rod
K550978	3	Spring clip with bent tip, short L = 30°
K550979	3	Spring clip with bent tip, short L = 15°
K550980	3	Spring clip with bent tip, long L = 30°
K550981	3	Spring clip with bent tip, long L = 15°
K551020	1	Allen key 1.5 mm
K551021	1	Allen key 2.0 mm
	51	

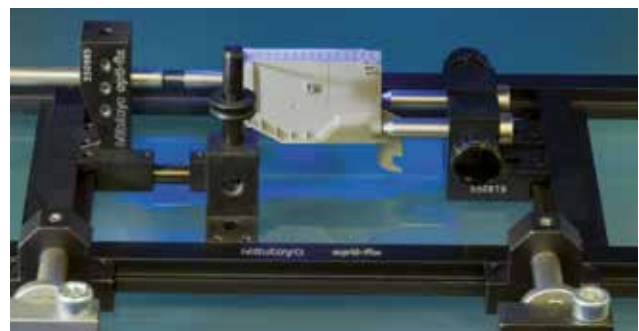



# Kit opti-set Professional



Part No.: K551060

Very complex kit, consisting of 115 parts, for construction of a basic frame with the dimensions of 400 mm x 250 mm, for fixing parts with very complex part geometry. The fixing of parts with a rotational part geometry is also available problem-free.

Fastening brackets, vacuum plates or magnetic holders for mounting the clamping system on the measuring machine, please order separately.

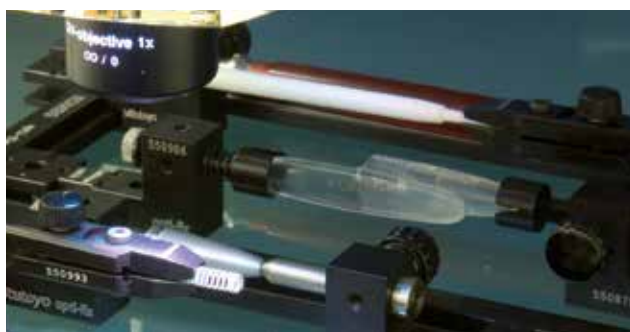

Part No.	Qty.	Part name
K550210	2	Clamping profile rail; L = 400 mm
K550836	4	Clamping profile rail; L = 250 mm
K550842	8	Connector with connector grooves
K550838	2	Clamping profile rail; L = 100 mm
K550985	2	Clamping block GK
K550984	2	Clamping block GG
K550213	2	Clamping block GKD, rotatable
K550165	3	Toothed fixture flat L = 40 mm
K550324	2	Toothed fixture flat L = 100 mm
K550845	1	Toothed fixture flat L = 40 mm
K551013	2	Toothed fixture flat with fine teeth L = 40 mm
K550853	8	Clamping fixture (with thread M4)
K550891	4	Straight pin for holding-down devices L = 30 mm
K551017	4	Straight pin for holding-down devices L = 12 mm
K550978	2	Spring clip with bent tip, short 30°
K550979	2	Spring clip with bent tip, short 15°
K550980	2	Spring clip with bent tip, long 30°
K550981	2	Spring clip with bent tip, long 15°
K550970	2	Eccentric receiver
K550972	2	Prismatic eccentric receiver
K550971	2	Prismatic receiver / locator
K550304	1	Receiver plane
K550301	3	Receiver pin stepped L = 60 mm
K550302	3	Receiver pin stepped L = 80 mm
K550303	3	Receiver pin stepped L = 100 mm
K550990	3	Rectangular receiver pin L = 50 mm
K550323	3	Rectangular receiver pin L = 25 mm
K551012	2	Spring-loaded clamping rod
K550879	1	Tailstock with centre
K550986	1	Tailstock with spring-loaded centre
K550839	4	Telescope fixture slider
K550852	4	Telescope fixture end piece
K550887	4	Straight pin 6 x 10 mm
K550888	4	Straight pin 6 x 20 mm
K550889	4	Straight pin 6 x 30 mm
K550890	4	Straight pin 6 x 40 mm
K550840	2	Knuckle joint with dovetail
K550851	2	Swivel receiver with knife edge
K550847	2	Swivel receiver with straight pin
K551018	1	Prism 120° compl. with spring clip
K551014	1	Precision quick chuck 0-4 mm
K551016	1	Adaptor plate M4
K551020	1	Allen key 1.5 mm
K551021	1	Allen key 2 mm
	115	

# Kit opti-set Round



Part No.: K550298

Kit consisting of 18 parts, with locating and clamping elements, incl. adaptor plates for adaptation to e.g. basic frame of the rail rail system Mitutoyo opti-fix. Fastening brackets, vacuum plates or magnetic holders for mounting the clamping system on the measuring machine, please order separately.

Part No.	Qty.	Part name
K550983	1	Circular clamping profile
K550976	2	Adaptor plate
K550977	1	Clamping block RKD; small, rotatable
K550969	1	Clamping block RK; small
K550968	2	Clamping block RG; large
K550302	3	Receiver pin 80 mm
K550970	1	Eccentric receiver
K550990	2	Rectangular receiver pin
K550870	1	Spring clip 15° short
K550849	1	Spring clip 15° long
K551012	1	Spring-loaded clamping rod
K551020	1	Allen key 1.5 mm
K551021	1	Allen key 2.0 mm
	18	

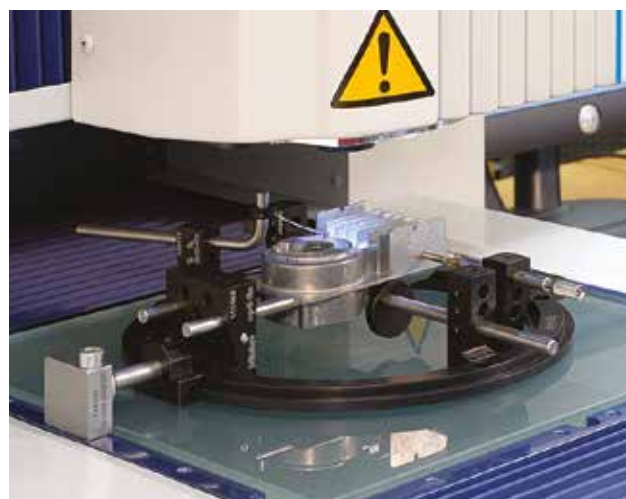

# System Components

## Clamping profile rail

With front connector groove  
for construction of basic frames

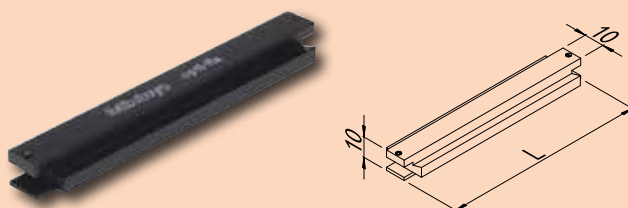

**Part No.:**

- K550838** L = 100 mm
  - K550859** L = 200 mm
  - K550835** L = 240 mm
  - K550836** L = 250 mm
  - K550991** L = 400 mm
  - K550920** L = 500 mm
- Further lengths available on demand

## Clamping profile rail

For construction of basic frames

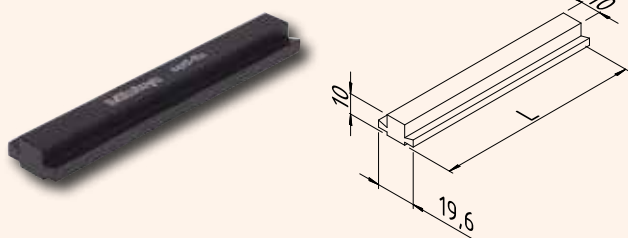

**Part No.:**

- K550861** L = 100 mm
  - K550857** L = 200 mm
  - K550854** L = 250 mm
  - K550210** L = 400 mm
  - K550992** L = 500 mm
- Further lengths available on demand

## Basic circular clamping profile "opti-round"

As base for receiving elements  
of "opti-round" type



**Part No.: K550983**

- Da = 190 mm
- Di = 170 mm

## Vacuum plate

For easy mounting of profiles or  
of the circular clamping profile  
directly on the glass plate of  
the measuring device

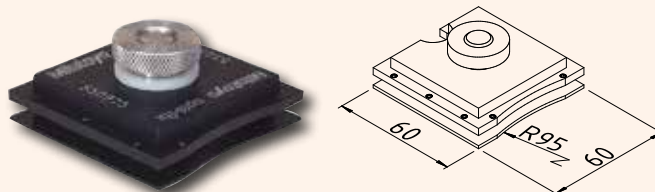

**Part No.: K550975**

60 mm x 60 mm

## Fastening bracket

For mounting of basic profiles  
or frames on measuring devices

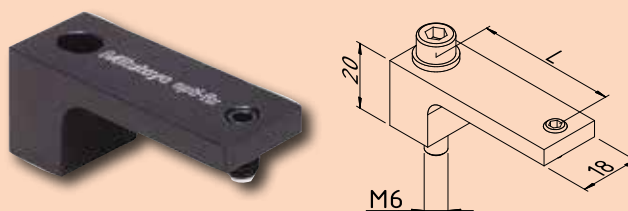

**Part No.:**

- K550886** 20 mm - 22 mm
- K550860** 24 mm - 26 mm
- K550185** 33 mm - 35 mm
- K550881** 36 mm - 38 mm
- K550882** 39 mm - 41 mm
- K550884** 44 mm - 49 mm
- K550883** 62 mm - 67 mm
- K550885** 82 mm - 87 mm

Further types available on demand

# SYSTEM COMPONENTS

## Connector with connector grooves

For rectangular connection of profile rails, respectively for reinforcement of profile connections

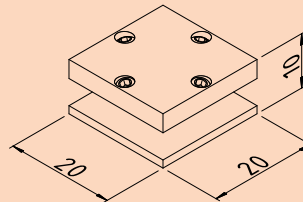
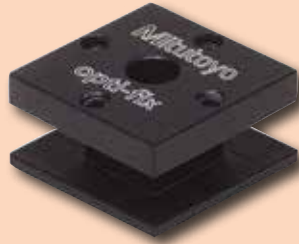

**Part No.: K550842**  
20 mm x 20 mm

## Connector with dovetail connector

E.g. for front connection to profile rails with connector groove

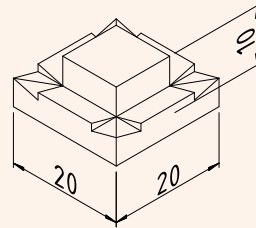
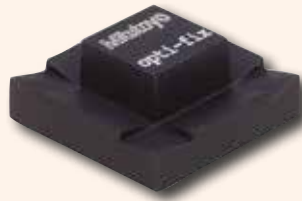

**Part No.: K550841**  
20 mm x 20 mm

## Adaptor plate

As adaptor between the straight profile rails and the basic circular clamping profile "opti-round"

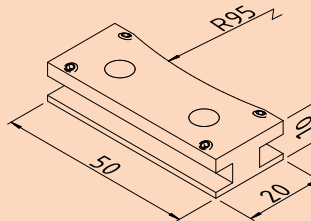

**Part No.: K550976**  
50 mm x 20 mm x 10 mm

## Magnetic holder Mag 1

For quick and easy mounting of opti-fix systems by magnets. Easy removing or mounting of complete opti-fix fixtures. Adjustable to the table dimension of the measuring devices.

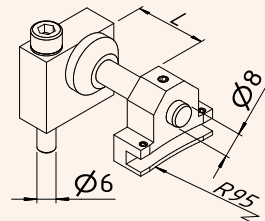

**Part No.: K550989**  
M6  
L = 7,5 mm - 25 mm  
Further lengths on demand

## Clamping knuckle

For creating of free angles, e.g. with the spring loaded clamping rod 551012

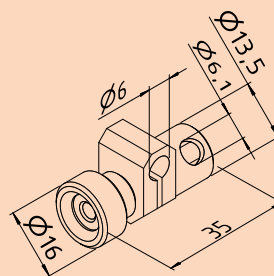

**Part No.: K551083**

# System Components

## Clamping block RK opti-round

For receiving of the system components such as e.g. receiver pin or eccentric receiver

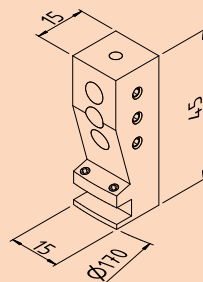

**Part No.: K550969**  
15 mm x 15 mm x 45 mm

## Clamping block RG opti-round

For receiving of the system components such as e.g. receiver pin or eccentric receiver

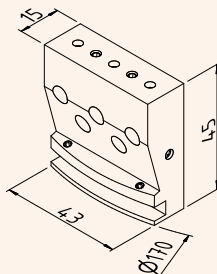

**Part No.: K550968**  
45 mm x 15 mm x 45 mm

## Clamping block RKD rotatable opti-round

For receiving of the system components such as e.g. receiver pin or eccentric receiver

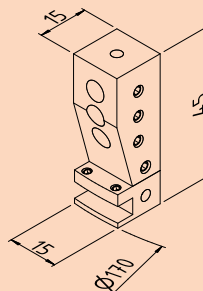

**Part No.: K550977**  
15 mm x 15 mm x 45 mm

## Telescope fixture slider

In connection with end piece and straight pin  $\varnothing$  6 mm for positioning of e.g. spring clip or location pin

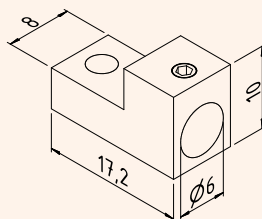

**Part No.: K550839**  
17 mm x 8 mm x 10 mm

## Straight pin $\varnothing$ 6 mm

As connecting element for telescope fixture

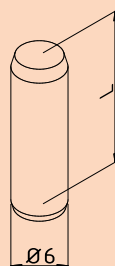

**Part No.:**  
K550887 L = 10 mm  
K550888 L = 20 mm  
K550889 L = 30 mm  
K550890 L = 40 mm



# SYSTEM COMPONENTS

## SYSTEM COMPONENTS

### Clamping block GK

For receiving of the system components such as e.g. receiver pin or eccentric receiver

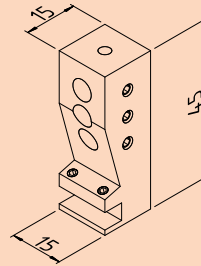

**Part No.: K550985**  
15 mm x 15 mm x 45 mm

### Clamping block GG

For receiving of the system components such as e.g. receiver pin or eccentric receiver

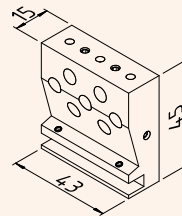

**Part No.: K550984**  
45 mm x 15 mm x 45 mm

### Clamping block GKD rotatable

For receiving of the system components such as e.g. receiver pin or eccentric receiver

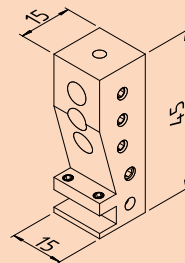

**Part No.: K550213**  
15 mm x 15 mm x 45 mm

### Holder 90°

e.g. for attaching a spring clip directly to a workpiece support

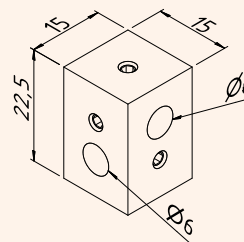

**Part No.: K551183**  
22 mm x 15 mm x 15 mm  
D1= 6 mm

### Telescope fixture end piece

In connection with slider and straight pin  $\varnothing$  6 mm for positioning of e.g. spring clip or location pin

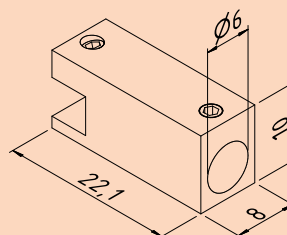

**Part No.: K550852**  
22 mm x 8 mm x 10 mm

# System Components

## Clamping fixture with M4 thread

For receiving of e.g. spring clip or location pin. Can be also used as locating element

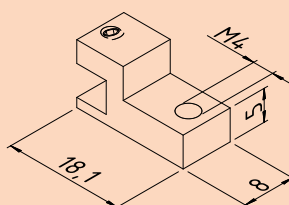

**Part No.: K550853**  
18 mm x 8 mm x 10 mm

## Toothed fixture

With longitudinal connector groove, as well as with M4 receiving thread for e.g. spring clips

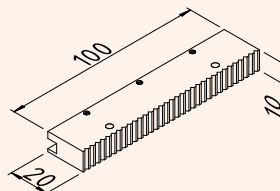

**Part No.: K550858**  
100 mm x 20 mm x 10 mm

## Toothed fixture flat

As direct workpiece locating element

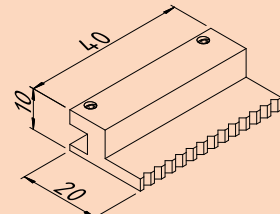

**Part No.:**  
**K550165** L = 40 mm  
**K550324** L = 100 mm

## Swivel receiver with straight pin

As workpiece locating element for direct positioning

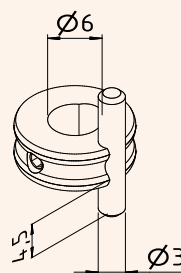

**Part No.: K550847**  
Receiving  $\varnothing$  6 mm /  
Locating  $\varnothing$  3 mm

## Knuckle joint with dovetail

In connection with clamping fixture for the construction of any angle

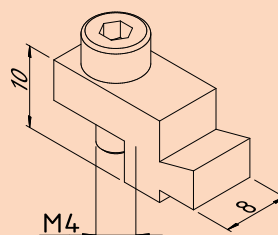

**Part No.: K550840**  
20 mm x 8 mm x 10 mm

# SYSTEM COMPONENTS

## SYSTEM COMPONENTS

### Toothed fixture

With longitudinal connector grooves and connector grooves at both ends as well as with M4 receiving thread for e.g. spring clips

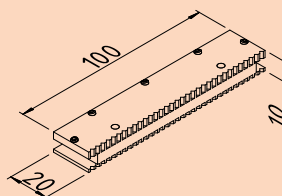

**Part No.: K550843**

100 mm x 20 mm x 10 mm

### Toothed fixture 40

As direct workpiece locating element

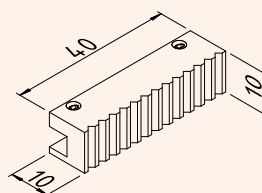

**Part No.: K550845**

40 mm x 10 mm x 10 mm

### Toothed fixture flat with fine teeth

As direct workpiece locating element

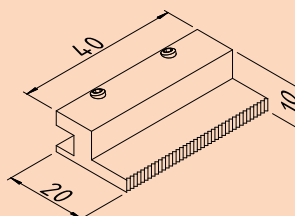

**Part No.: K551013**

40 mm x 20 mm x 10 mm

### Swivel receiver with knife edge

As workpiece locating element for direct positioning

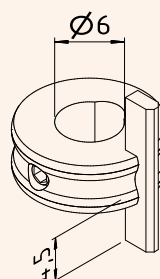

**Part No.: K550851**

Receiving  $\varnothing$  6 mm

# System Components

## Eccentric receiver

As height-adjustable workpiece receiving element for mounting in the clamping blocks

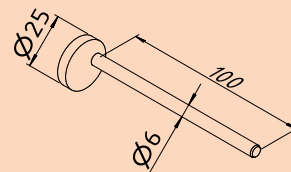

**Part No.: K550970**

L = 100 mm  
 $\varnothing = 25$  mm

## Prismatic eccentric receiver

As height-adjustable workpiece receiving element for mounting in the clamping blocks

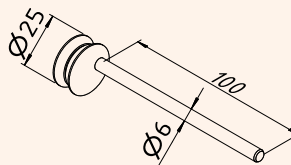

**Part No.: K550972**

L = 100 mm  
 $\varnothing = 25$  mm

## Prismatic receiver/locator

As workpiece receiving element for mounting in the clamping blocks

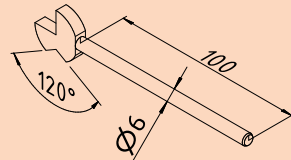

**Part No.: K550971**

L = 100 mm  
 Prism = 120°

## Receiver plane

In connection with the clamping blocks, it can be used as direct workpiece locating element for free positioning

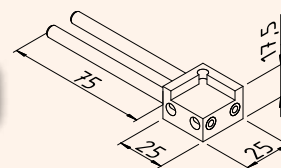

**Part No.: K550304**

L = 100 mm/  
 25 mm x 25 mm

## Spring-loaded clamping rod

For pressing specimens against e.g. locating element

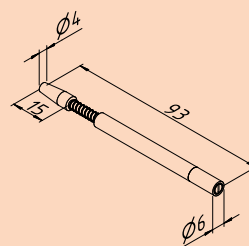

**Part No.: K551012**

$\varnothing 6$  mm x 93 mm

# SYSTEM COMPONENTS

## SYSTEM COMPONENTS

### Spring clip with bent tip

For clamping of specimens

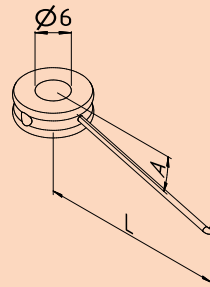

Part No.:

**K550978** A = 30° L = 19 mm

**K550979** A = 15° L = 20 mm

**K550980** A = 30° L = 33 mm

**K550981** A = 15° L = 37 mm

### Receiver pin stepped

In connection with the clamping blocks, it can be used as direct workpiece locating element for free positioning

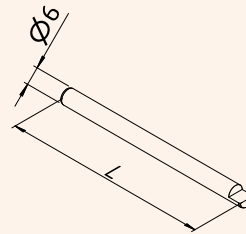
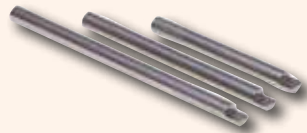

Part No.:

**K550301** L = 60 mm

**K550302** L = 80 mm

**K550303** L = 100 mm

### Receiver pin stepped mini

In connection with the clamping blocks, it can be used as direct workpiece locating element for free positioning of very small workpieces.

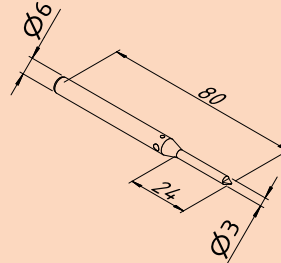

Part No.: **K551915**

D 1 = 6 mm / D2 = 3 mm

L = 80 mm / L1 = 25 mm

### Straight pin $\varnothing 6$ mm

With M4 threaded pin, as receiving element for spring clips

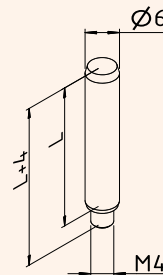

Part No.:

**K550891** L = 30 mm

**K551017** L = 12 mm

### Rectangular receiver pin

As receiving element for spring clip

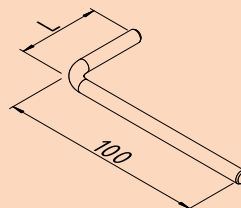
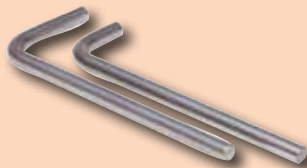

Part No.:

**K550990** L = 50 mm

**K550323** L = 25 mm



# System Components

## Precision quick chuck

With M4 receiving thread, for mounting of e.g. adaptor 551016 or other elements with M4 connecting thread

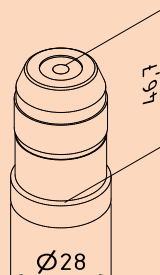

**Part No.: K551014**

Clamp. range: 0 - 4 mm  
Total length: 47 mm

## Prism 120° compl. with spring clip

For attachment to e.g. articulated arms or clamping blocks, for receiving of specimens ranging from Ø 2 mm to Ø 25 mm

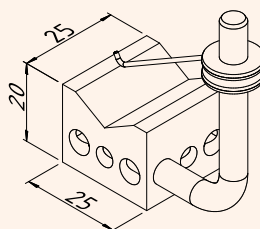

**Part No.: K551018**

20 mm x 25 mm

## Tailstock with centre

For receiving of specimens between the tips

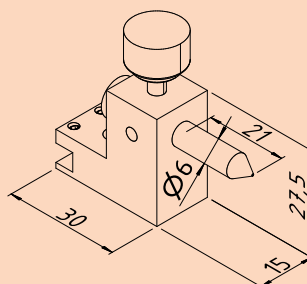

**Part No.: K550879**

Tip height: 20 mm  
Adjust. range: 16 mm

## Tailstock centre stepped for tailstock (N° K550879)

The step at the tip makes length scanning easier, especially in case of the transmitted light method

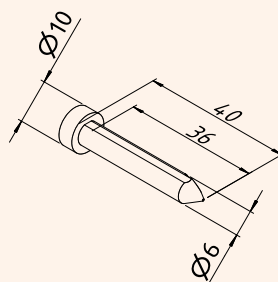

**Part No.: K550333**

Tip: Ø 6 mm

## Precision vice for inside and outside clamping

With stepped receiver columns for clamping of most different specimen types

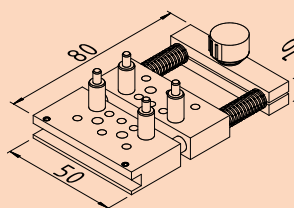

**Part No.: K551010**

Clamping range: 10 mm - 50 mm

Extension of the clamping range can be realised by exchange of the guiding columns

# SYSTEM COMPONENTS

## Adaptor plate M4

For receiving of all elements with M4 connecting thread

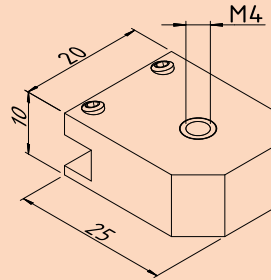

Part No.: K551016

25 mm x 20 mm x 10 mm

## Adaptor plate M6

For receiving of all elements with M6 connecting thread

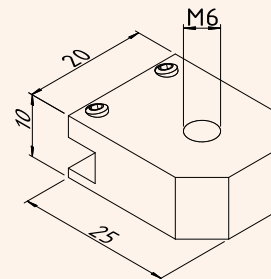

Part No.: K551015

25 mm x 20 mm x 10 mm

## Tailstock with spring-loaded centre

In combination with part No. 550879 for easy and quick receiving of the specimens between the tips

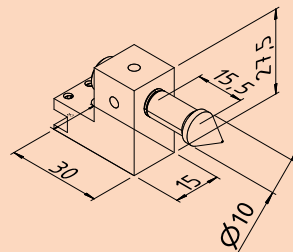

Part No.: K550986

Tip height: 20 mm

Stroke: 8 mm

## Tailstock centre stepped for tailstock with spring-loaded centre (N° K550986)

The step at the tip makes length scanning easier, especially in case of the transmitted light method

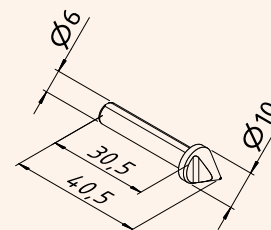

Part No.: K550334

Tip:  $\varnothing$  10 mm

## Ratchet spanner

For receiving of e.g. clamping tweezers, miniature precision chucks and all clamping elements with receiving diameter 6 mm

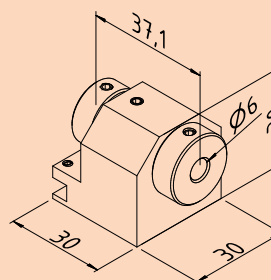

Part No.: K551011

Tip height: 15 mm

Circular positioning: 24° x 15°

# System Components

## Clamping tweezers

consisting of:

**Basic element N° K550993**

**Exchangeable tips N° K550997**

For clamping of small and smallest specimens, receiving of the clamping tweezers in e.g. rotatable and swivel receiver, tailstock, clamping blocks or articulated arm. The use of different exchangeable tips allows extension of the clamping ranges at a reasonable price.

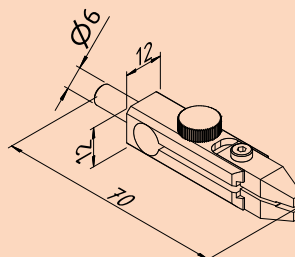

**Part No.: K551019**

Clamp. range: 0,5 mm - 1,5 mm

Clamp. width: 3 mm

## Pair of exchangeable tips for clamping tweezers N° K551019

For clamping of small and smallest specimens

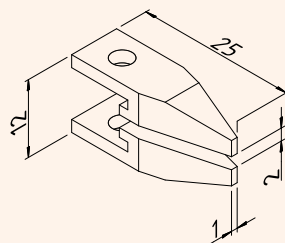

**Part No.: K551008**

Clamp. range: 0 mm - 2 mm

Clamp. width: 1 mm

## Pair of exchangeable tips for clamping tweezers N° K551019

For clamping of small and smallest specimens

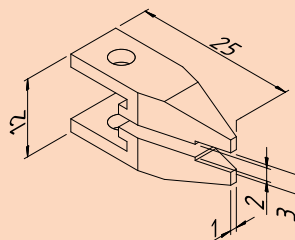

**Part No.: K551009**

Clamp. range: 1 mm - 3 mm

Clamp. width: 1 mm

## Pair of exchangeable tweezers for clamping tweezers N° K551019

For clamping of small and smallest specimens

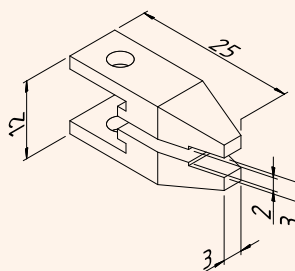

**Part No.: K551007**

Clamp. range: 1 mm - 3 mm

Clamp. width: 3 mm

## Pair of exchangeable prismatic tips for clamping tweezers N° K551019

For clamping of small and smallest rotationally symmetrical specimens

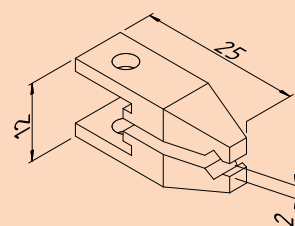

**Part No.: K550998**

Clamp. range:  $\varnothing$  4 mm -  $\varnothing$  5 mm

# SYSTEM COMPONENTS

**Pair of exchangeable prismatic tips for clamping tweezers N° K551019**

For clamping of small and smallest rotationally symmetrical specimens

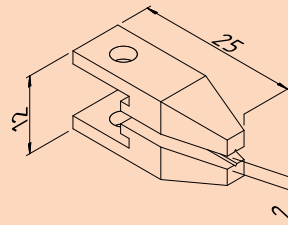

**Part No.: K550999**

Clamp. range:  $\varnothing$  0,5 mm -  $\varnothing$  2 mm

**Pair of exchangeable prismatic tips for clamping tweezers N° K551019**

For clamping of small and smallest rotationally symmetrical specimens

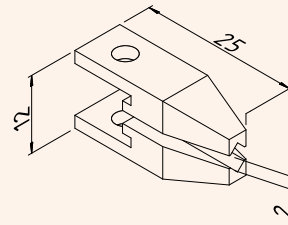

**Part No.: K551003**

Clamp. range:  $\varnothing$  2 mm -  $\varnothing$  3 mm

**Pair of exchangeable prismatic tips for clamping tweezers N° K551019**

For clamping of small and smallest rotationally symmetrical specimens

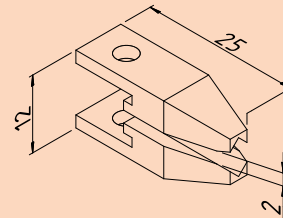

**Part No.: K551004**

Clamp. range:  $\varnothing$  3 mm -  $\varnothing$  4 mm

**Pair of exchangeable prismatic tips for clamping tweezers N° K551019**

For clamping of small and smallest rotationally symmetrical specimens

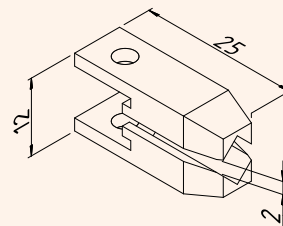

**Part No.: K551005**

Clamp. range:  $\varnothing$  4 mm -  $\varnothing$  5 mm

**Pair of exchangeable prismatic tips for clamping tweezers N° K551019**

For clamping of small and smallest rotationally symmetrical specimens

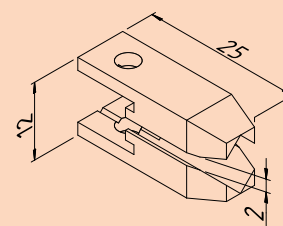

**Part No.: K551006**

Clamp. range:  $\varnothing$  5 mm -  $\varnothing$  6 mm

# System Components

**Hydraulic articulated arm mini**  
With M4 connecting thread

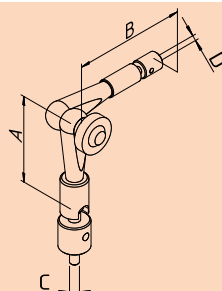

**Part No.: K550703**  
A = 60 mm  
B = 60 mm  
C = M6  
D = M4

**Clamping unit mini**  
With M4 connecting thread,  
for mounting to e.g. articulated  
arm or M4 adaptor (551016)

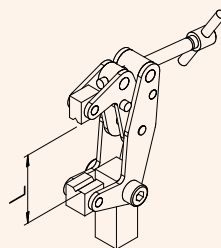

**Part No.: K550707**  
Clamp. range: 0 mm - 25 mm

**Holder for spring clip**  
Receiving block for receiving of  
e.g. spring clip or other ele-  
ments with M4 thread

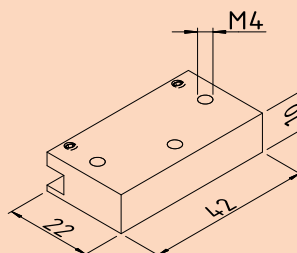

**Part No.: K550850**  
42 mm x 22 mm x 10 mm

**Centering unit**  
For centering of parts without  
centre hole

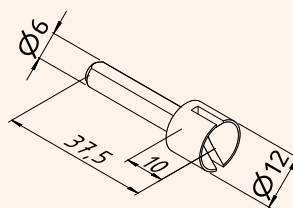

**Part No.: K550994**

**T-slot nut M5**  
For mounting of opti-fix  
systems to e.g. projectors or  
microscopes

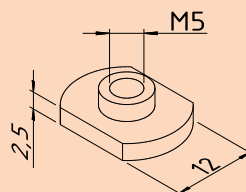

**Part No.: K550963**  
12 mm x 2,5 mm



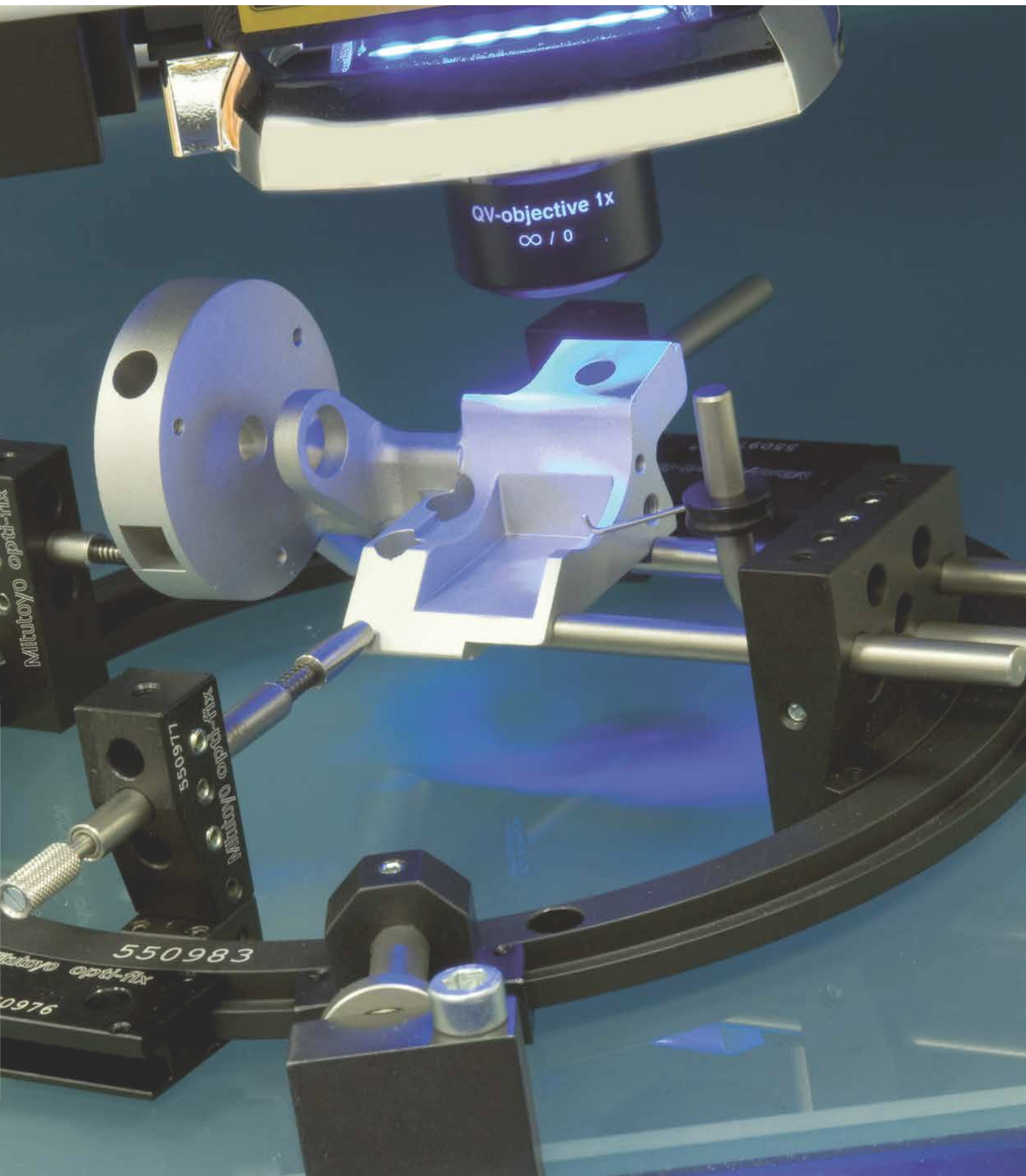

## Mitutoyo custom made clamping and loading solutions

Apart from our rich portfolio of standard solutions, we are also specialized in any kind of custom made solutions for clamping, loading and measurement. Manual loading systems and fully automated solutions can be made to order in true bespoke style to suit any kind of requirement.

Contact us to benefit from our longstanding experience and high standard.

### Pre Sales

- Consulting
- Conception

### Project Management

- Planning
- Engineering
- Production
- System Integration
- Initial Operation
- Training

### After Sales

- Service
- Support



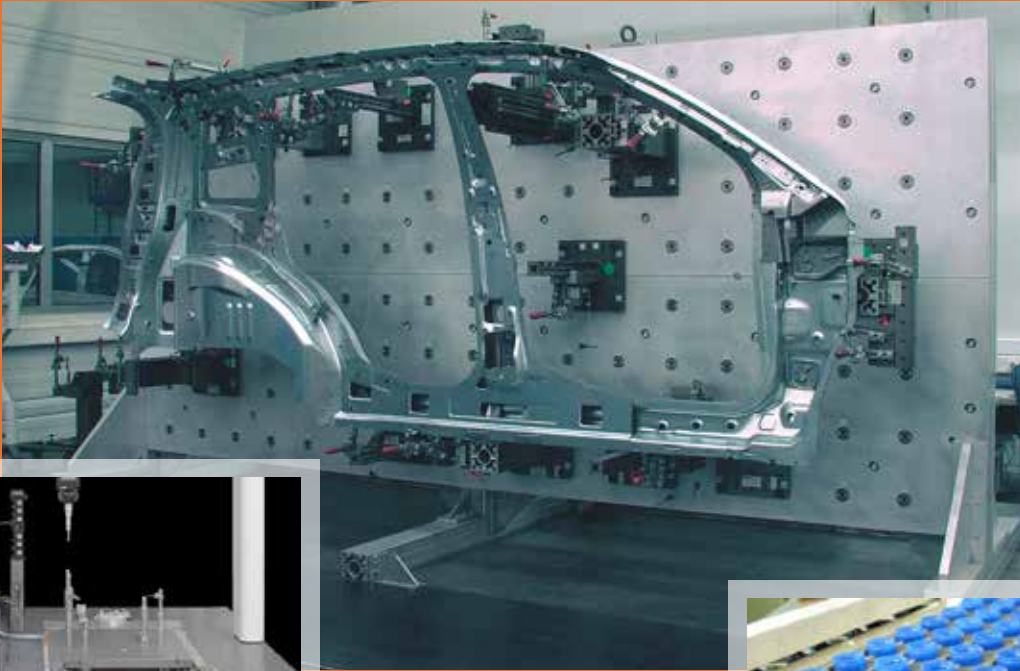

Mitutoyo COORDINATE MEASURING MACHINE  
**MACH-V** 9106





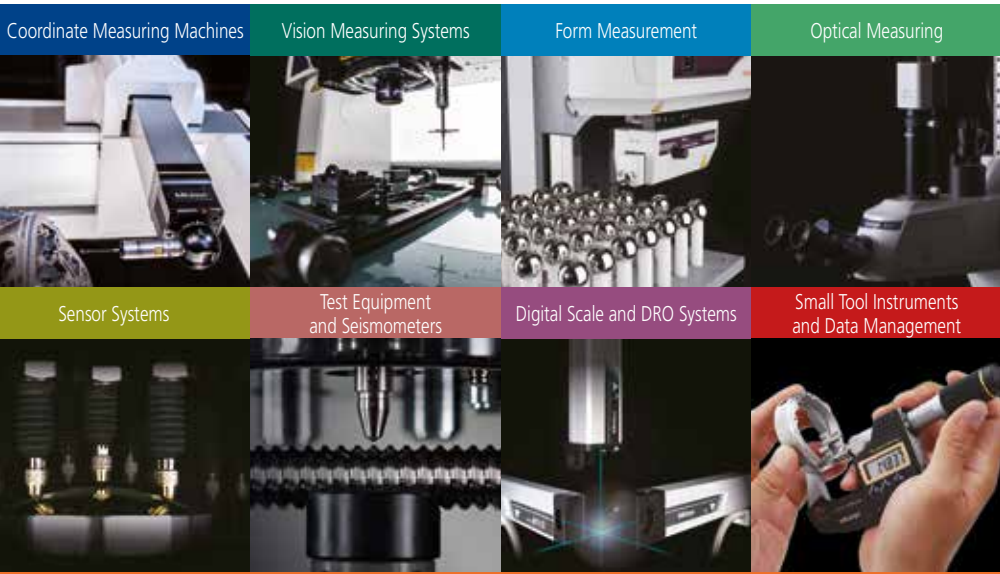

**Whatever your challenges are, Mitutoyo supports you from start to finish.**

Mitutoyo is not only a manufacturer of top quality measuring products but one that also offers qualified support for the lifetime of the equipment, backed up by comprehensive services that ensure your staff can make the very best use of the investment.

Apart from the basics of calibration and repair, Mitutoyo offers product and metrology training, as well as IT support for the sophisticated software used in modern measuring technology. We can also design, build, test and deliver bespoke measuring solutions and even, if deemed cost-effective, take your critical measurement challenges in-house on a sub-contract basis.



Find additional product literature and our product catalogue

**Mitutoyo**



**WILLRICH PRECISION  
INSTRUMENT**  
*THINK MEASUREMENT... THINK WILLRICH*

Ph 866-945-5742 email:sales@willrich.com