



**WILLRICH PRECISION
I N S T R U M E N T**
THINK MEASUREMENT... THINK WILLRICH
Ph 866-945-5742 email:sales@willrich.com



Messtechnik GmbH & Co. KG



IMS

measuring probes

CD43, CD70

computer displays

SD1

sensor display

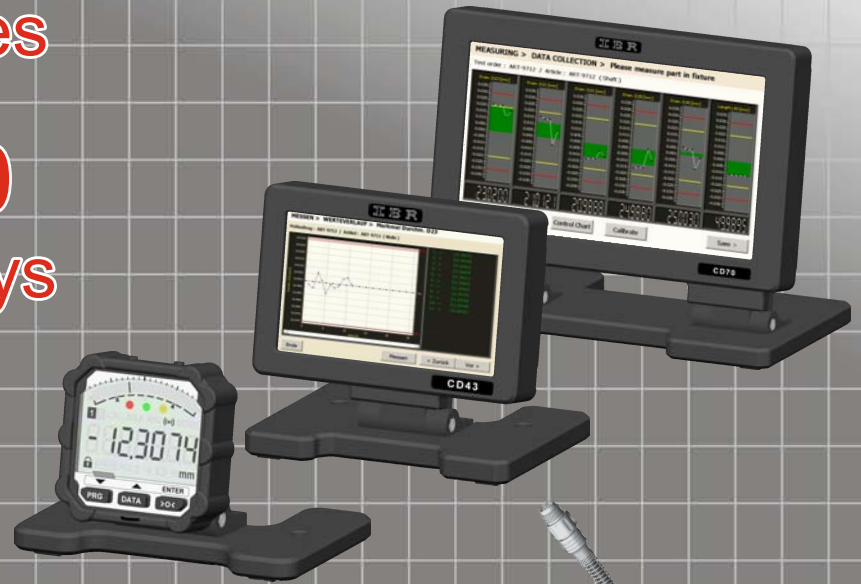

IMS measuring probe series

IMS probe - a new generation of inductive measuring probes with integrated signal processing and digital interface.

The new IMS measuring probes are based on the reliable clearance-free ball bearings and the robust inductive measuring principle. But the sensible and sensitive analogue measuring signals are no longer transferred out of the case of the measuring probe via cables and then measured externally by electronics, instead they are processed and digitised directly inside the IMS measuring probes. An innovative measuring principle and highly integrated electronics make this milestone of new generation IMS measuring probes possible.











Comparison of ind. probes

Technical data :

	old	new
Mechanical characteristics	Standard	IMS
Compact tube case, stainless steel 8h6	✓	✓
High protection class for rough environments	✓	✓
Clearance-free ball bearing for precise mea.	✓	✓
Gauge spindle Ø 4, gauge slide M2.5	✓	✓
Actuation by spring, vacuum, compressed air	✓	✓
Cable pluggable at measuring probe for simple mounting / exchange on fixtures	(rarely)	✓
Simple extension of cables without influence on measuring values		✓
Bus cables for drastic reduction of connection cables and wiring		✓
Characteristics of integrated electronics		
Optimal stable sensor signals without influence by cable / external interferences		✓
Individual error correction of each probe		✓
Adjustment tolerance of sensitivity [%]	0.3...0.6	< 0.05
Max. linearity error (+/- 2 mm) [µm]	< 24	< 1
Temperature drift [ppm / °C]	100	20
No errors by external measuring electronics		✓
Integrated temperature measurement provides temperature of measuring probe / fixture		✓
Interface		
Simple wiring with ISi connection adapters and pluggable ISi extension cables to a bus with up to 60 probes / sensors (ISi bus)		✓
Identification of IMS measuring probes : Type, serial number, ..., next date of inspection can be requested directly from the probe		✓

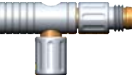
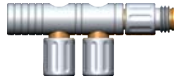
Technical data : Measuring probe IMS-5S

Metrological characteristics	
Measuring range	5 mm
Resolution	0.1 µm, optional 0.01 µm
Accuracy	< 1 µm
Measuring rate	1500 measuring values / sec (0.1 µm)
Measuring force	0.7 N / (optional 0.4 ... 2.0 N)
Electrical characteristics	
Supply voltage	2.7 ... 3.6 V
Power consumption	2.8 µA / measurement per second
Characteristics of integrated temperature sensor	
Measuring range	-20 °C ... 80 °C
Resolution	0.25 °C
Accuracy	+/- 1.5 °C
Environmental conditions	
Operation / Storage temp.	+32 ... +122 °F / -4 ... +158 °F

Type	Article
IMS-5S	IMS measuring probe, 5 mm measuring range, spring pushed / vacuum lifting 
IMS-5P	IMS measuring probe, 5 mm measuring range, pneumatically pushed 
ISi-cca	ISi connection cable, axial 
ISi-ccap	ISi connection cable, axial, pneumatic 
ISi-ccr	ISi connection cable, radial 
ISi-ccrp	ISi connection cable, radial, pneumatic 
ISi-ca1	ISi connection adapter, single 
ISi-ca2	ISi connection adapter, double 
ISi-ca4	ISi connection adapter, quadruple 
ISi-USB	ISi connection adapter for USB 
ISM-ISi	ISi radio module for ISM band
BLE-ISi	ISi radio module for Bluetooth BLE 

Capability of connection for IMS probes

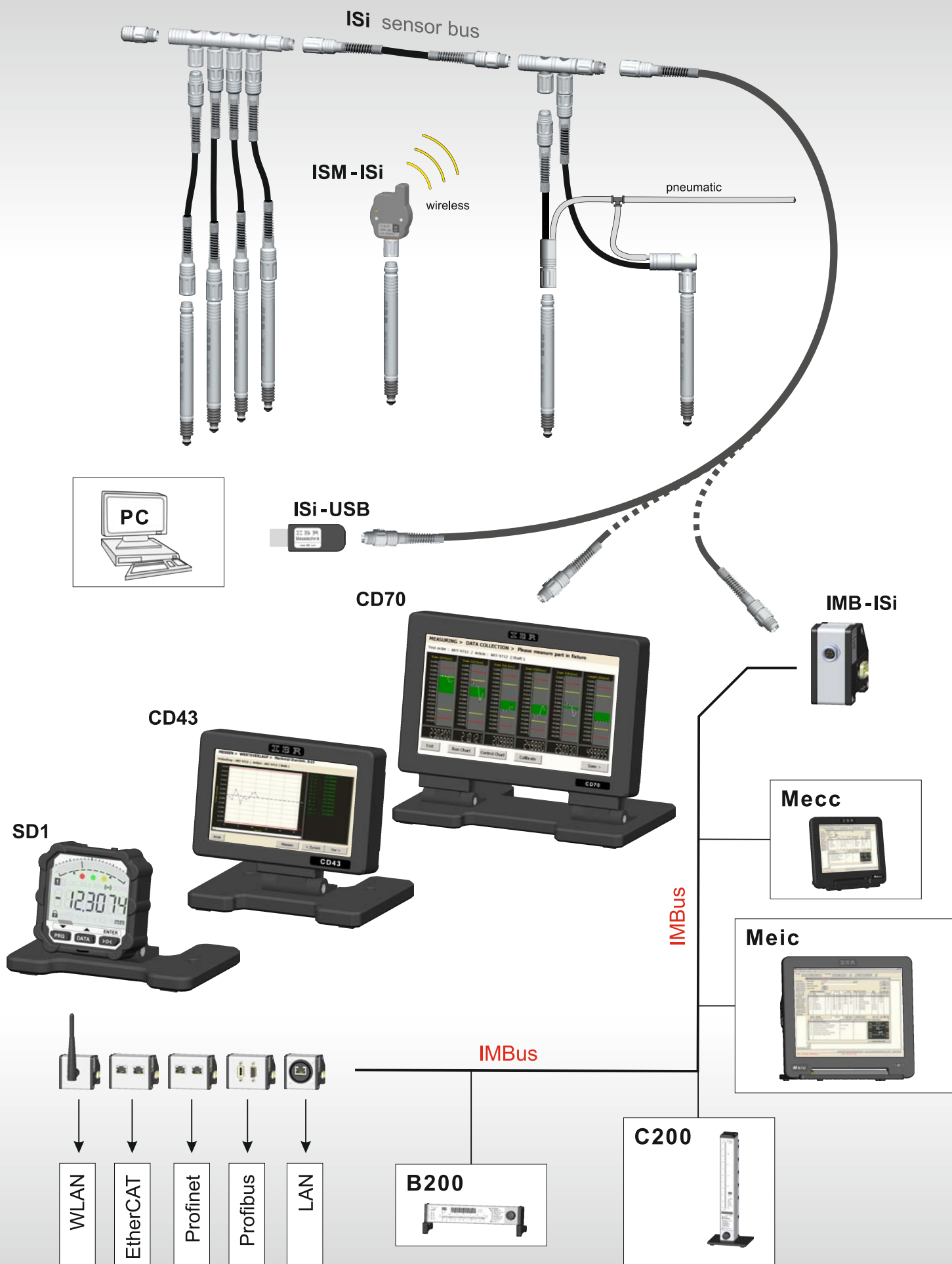

SD1 universal sensor display

The sensor display unit **SD1** was especially developed for industrial use. The robust aluminium case with rubber shock protection as well as a high protection class allow usage in rough manufacturing environment. The display is rotatable, a numeric display shows the measuring values with high resolution and an analogue display with coloured LEDs presents clearly the tolerance status of the component.

The sensor display SD1 features a large scope of operation and can be configured freely for the particular application as required by a windows software. Thereby functions can be removed or activated and settings can be preset.

Image : Front panel

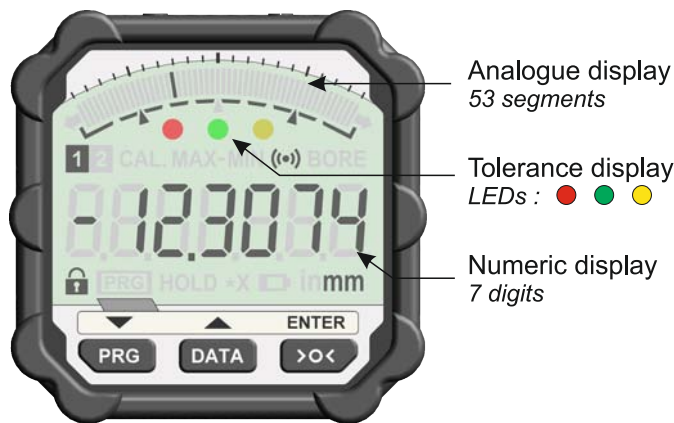
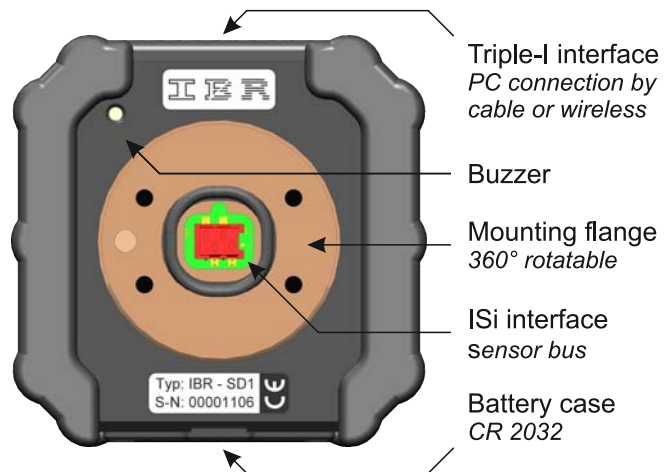

Image : Back panel



Technical data :

Mechanical characteristics	
Case	Aluminium, rubber shock protection
Front plane	Acryl glass (scratch-proof coated)
Dimensions / Weight	(WxHxD) 60 x 59.5 x 21.7 mm / 95 g
Electrical characteristics	
Power supply	Battery (CR2032)
Battery lifetime	approx. 8000 h (SD1 incl. probe)
Measuring rate	adjustable, 2 ... 20 values / sec
LCD display	
Display type	Liquid crystal display, reflective
Numeric display	7 digits (10.5 mm)
Analogue display	53 segments
LEDs / Acoustical output	
Tolerance display	3 LEDs : 1x red, 1x green, 1x yellow
Buzzer	Piezo
Connections	
ISi interface	Bus connection for sensors, hand / foot switch, tolerance adapter, ...
Triple-I interface	Connection for IBR radio modules or cable with USB / RS232 interface
Measuring systems	
Measuring range, resolution, precision, ... are defined by the connected measuring probe or sensor. Example : Measuring probe IMS-5S → Range 5mm, Resolution 0.1µm	
Environmental conditions	
Operation / Storage temp.	+41 ... +113 °F / -4 ... +158 °F
Protection class	IP65 (CEI / IEC 529)
EMC according to EN50081 - 2 and EN50082 - 2	

Software functions :

Basic functions	
Unit / Measuring direction	mm, inch / positive, negative
Resolution	0.001 / 0.0001 / optional 0.00001 mm
Measuring inputs	
Number	2
Combination by factors	±0.001 ... ±59.999 per measuring input
Measuring mode	
Static measurement	Yes / optional Hold mode
Dynamic measurement	Min, Max, TIR, Mean, Bore
Calibration	
Zero adjustment / Preset	with one master
Calibration	with two masters (gain & offset)
Forced calibration	by temperature change or elapsed time
Tolerance limits / Grading	
Tolerance type	Absolute tolerance limits or nominal size with relative tolerances
Number of grades	2 ... 30
Handling and communication	
Favorite buttons	freely definable for each button
Hand / foot switch	send measuring value, calibrate, ...
Tolerance adapter	output tolerance status / grade
Triple-I interface	measuring value output, programming
Password protection	for programming / for calibration
Configuration of analogue display	
Display mode	Bargraph / Single segment
Bargraph origin	Left / Center / Right
Special features	
Windows software for configuration of sensor display SD1	

SD1 short operating instruction :



Key function in :	Measuring mode	Programming menu
PRG	Call programming menu	▼ Decrease flashing display (- 1)
> 2 sec.	Freely programmable favorite key	Exit programming menu
DATA	Data transfer Start / Stop dynamic measurement	▲ Increase flashing display (+ 1)
> 2 sec.	Freely programmable favorite key	- - -
>O<	Zero adjustment	ENTER Confirm flashing display
> 2 sec.	Freely programmable favorite key	Exit menu item

Windows configuration software SD1_Win.exe

Menu view on SD1 LCD display

- Unit
- rESoL.
- dir.

- PrESEt
- 2-CAL.
- dt.-CAL.
- tF.-CAL.

- FACTOR / ProBES

- SEt. OP.

- GrAdinG

- SEt. Pnt.
- SEt. toL.

- toL. LED

- CoL. diS.

- hoLd

- but. PRG.
- but. dAtA.
- but. CAL.

- FootS.

- P.C. ProG.
- P.C. CAL.

- Auto.oFF
- SA.rAtE
- BEEP

High precision dial gauge SD1 - IB5

The SD1-IB5 is a high precision dial gauge with a free of clearance ball bearing and a linearized, inductive absolute measuring system. The dial gauge was specially designed for industrial use in rough manufacturing environment.

Type	Article
SD1-IB5	High precision dial gauge, spring pushed
SD1-IB5P	High precision dial gauge, pneumatically pushed
SD1-IB5V	High precision dial gauge with vacuum lifting

Technical data : SD1-IB5

Mechanical characteristics	
Case	Aluminium, rubber shock protection
Front plane	Acryl glass (scratch-proof coated)
Dimensions / Weight	(WxHxD) 58 x 111 x 35,5 mm / 192 g
Electrical characteristics	
Power supply	Battery (CR2032)
Battery lifetime	approx. 8000 h
Metrological characteristics	
Measuring range	5 mm
Resolution	0.1 μm , optional 0.01 μm
Accuracy	< 1 μm
Measuring rate	adjustable, 2 ... 20 values / sec
Measuring force	0.7 N (optional 0.4 ... 2.0 N)
Environmental conditions	
Operation / Storage temp.	+41 ... +113 °F / -4 ... +158 °F
Protection class	IP65 (CEI / IEC 529)
EMC according to EN50081 - 2 and EN50082 - 2	



Note :
The IB5 measuring sensor is fixed with 4 screws on the display and is to exchange.

Modular dial gauge SD1 - PH1

The SD1-PH1 is a modular dial gauge designed to work with IMS measuring probes.

Type	Article
SD1-PH1	Modular dial gauge with changeable IMS measuring probe (spring pushed)

Technical data : SD1-PH1

Mechanical characteristics	
Case	Aluminium, rubber shock protection
Front plane	Acryl glass (scratch-proof coated)
Dimensions / Weight	(WxHxD) 58 x 111 x 35,9 mm / 165 g
Electrical characteristics	
Power supply	Battery (CR2032)
Battery lifetime	approx. 8000 h
Measuring rate	adjustable, 2 ... 20 values / sec
Measuring system	
Measuring range, resolution, accuracy, ... are defined by the connected measuring probe or sensor. Example : Measuring probe IMS-5S → Range 5mm, Resolution 0.1 μm	
Environmental conditions	
Operation / Storage temp.	+41 ... +113 °F / -4 ... +158 °F
Protection class	IP65 (CEI / IEC 529)
EMC according to EN50081 - 2 and EN50082 - 2	



Compact display SD1 - CC1

The SD1-CC1 is a very efficient, powerful display with ISi-Bus interface. Due to the ISi bus, several sensors, foot and hand switches and tolerance adapters can be connected.

Technical data : SD1-CC1

Mechanical characteristics	
Case	Aluminium, rubber shock protection
Front plane	Acryl glass (scratch-proof coated)
Dimensions / Weight	(WxHxD) 58 x 58 x 32,8 mm / 149 g
Electrical characteristics	
Power supply	Battery (CR2032)
Battery lifetime	approx. 6000 h (incl. 2 probes)
Measuring rate	adjustable, 2 ... 20 values / sec
Connections	
ISi interface	Bus connection for sensors, hand / foot switch, tolerance adapter, ...
Triple-I interface	Connection for IBR radio modules or cable with USB / RS232 interface
Environmental conditions	
Operation / Storage temp.	+41 ... +113 °F / -4 ... +158 °F
Protection class	IP65 (CEI / IEC 529)
EMC according to EN50081 - 2 and EN50082 - 2	

Type	Article
SD1-CC1	Compact display with ISi-Bus interface
SD1-mounting bracket	Slewable mounting bracket
SD1-pedestal	Pedestal for compact display

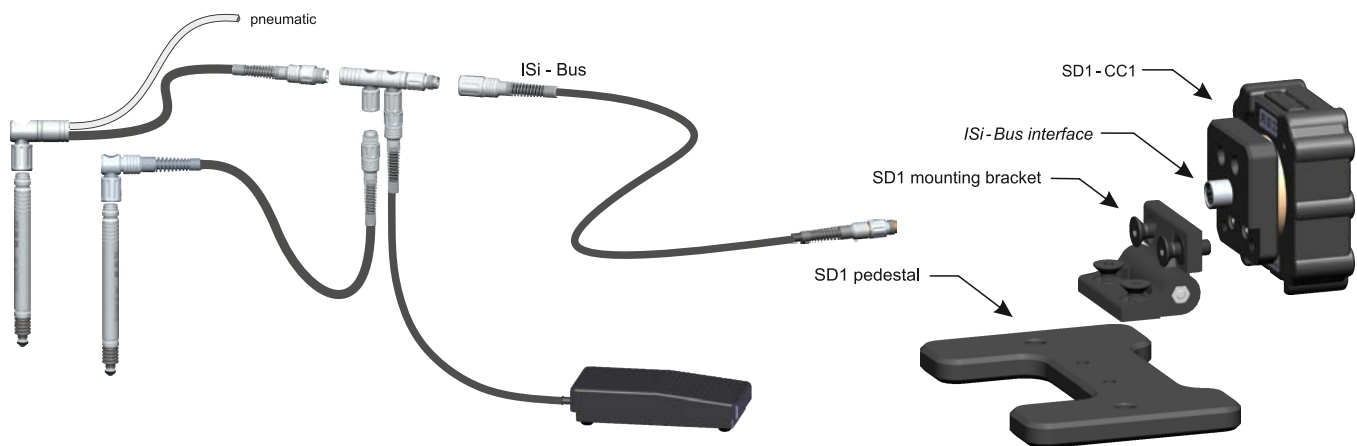

Accessories for SD1 dial gauges and displays

Type	Article
3i-USB	Triple -I connection cable for USB interface
3i-232	Triple -I connection cable for RS232 interface
ISM-3i	Triple -I radio module for ISM band
BLE-3i	Triple -I radio module for bluetooth BLE

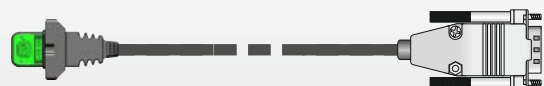

CD43 computer display for industrial use

The computer display **CD43** is a small and powerful display unit for measuring applications, which cannot be simply solved by using dial gauges. The robust aluminium case as well as a high protection class allow usage in rough manufacturing environment. The new sensor interface ISi bus allows connection of up to 60 measuring probes, sensors, hand- and foot switches. For fast and simple solving of measuring applications as well as for trend display of the production process, the CD43 is delivered with the user-friendly software ComGage Level 1.

Features

- Compact and robust construction with solid, sealed metal case (incl. connector caps for IP64), passive cooling and 4.3" TFT-Display (480 x 272) with touch screen, adjustable angle of tilt.
- ISi sensor bus for connecting 1...60 IMS probes, sensors, hand / foot switches, tolerance adapters.
- USB host (mouse, keyboard, USB stick) and USB client (data exchange with PC).

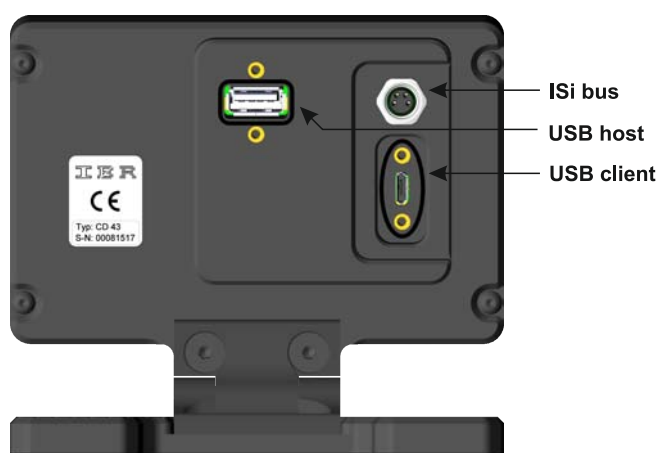

Technical data :

Mechanical characteristics	
Case with foot	Aluminium powder-coated
Dimensions / Weight	(WxHxD) 118 x 95 x 72.5 mm / 420 g
Protection class	Front side IP65, CEI / IEC 529 Rear side IP64 with connector caps
Electrical characteristics	
External power supply	100 ... 240 VAC, 6 Watt
Max. power consumption	1.8 Watt (without sensors)
Computer characteristics	
Display	4,3" TFT, resolution 480 x 272 (adjustable angle of tilt)
Touch Screen	4-wire analogue resistive
CPU	Vybrid VF50, 400 MHz
Memory	128 MB RAM, 128 MB Flash
Operating system	Windows CE 6
Measuring software	ComGage Level 1
Connections	
Standard PC connections	1 x USB client, 1 x USB host
ISi interface	60 sensors / clients
Environmental conditions	
Operation / Storage temp.	+41 ... +113 °F / -4 ... +158 °F

CD43 application

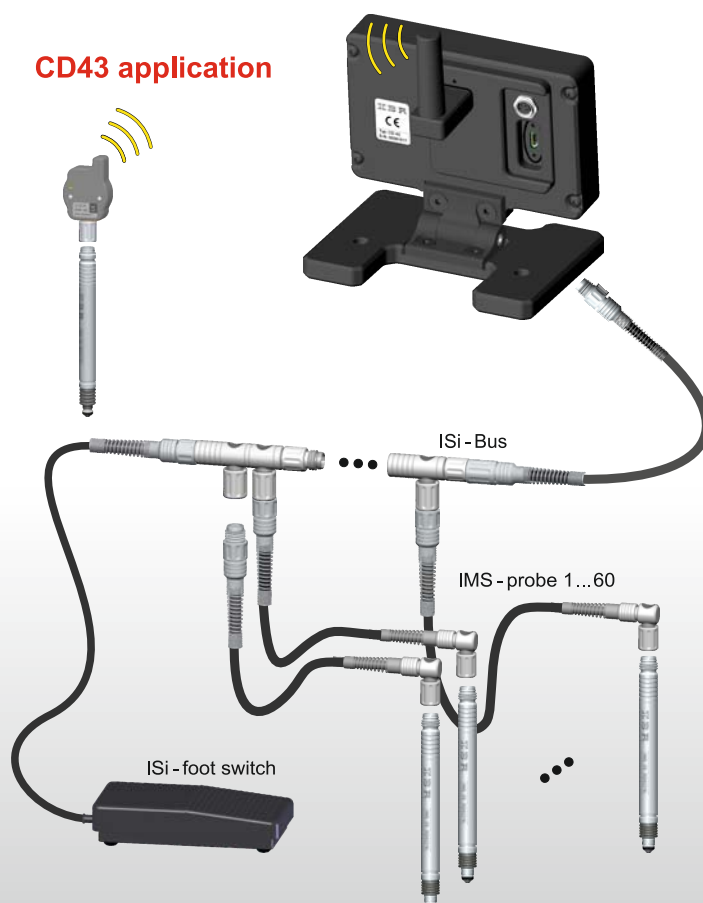

CD70 computer display for industrial use

The computer display **CD70** is a compact and powerful display unit for measuring applications, which cannot be simply solved by classic gauges like e.g. column gauges and digital gauges. The robust aluminium case as well as a high protection class allow usage in rough manufacturing environment. The new sensor interface ISi bus allows connection of up to 60 measuring probes, sensors, hand- and foot switches. For fast and simple solving of measuring applications as well as for trend display of the production process, the CD70 is delivered with the user-friendly software ComGage Level 1. An upgrade to ComGage Level 2 is possible.

Features

- Compact and robust construction with solid, sealed metal case (incl. connector caps for IP64), passive cooling and 7.0" TFT-Display (800 x 480) with touch screen, adjustable angle of tilt.
- ISi sensor bus for connecting 1...60 IMS probes, sensors, hand / foot switches, tolerance adapters.
- USB host (mouse, keyboard, USB stick), USB client (data exchange with PC) and LAN connection.

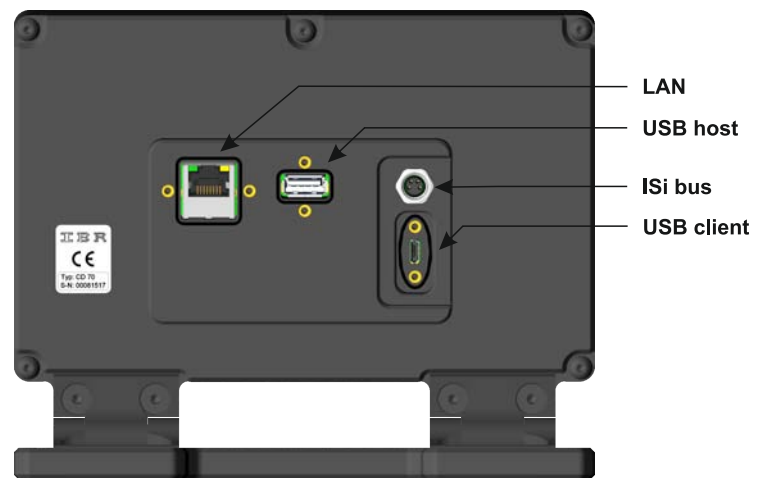
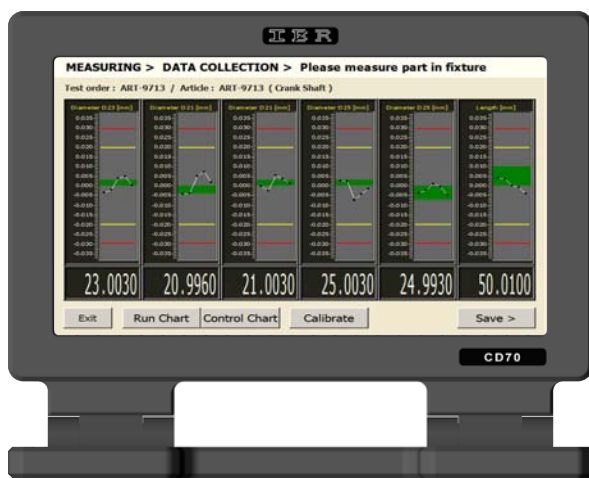

CD70 application

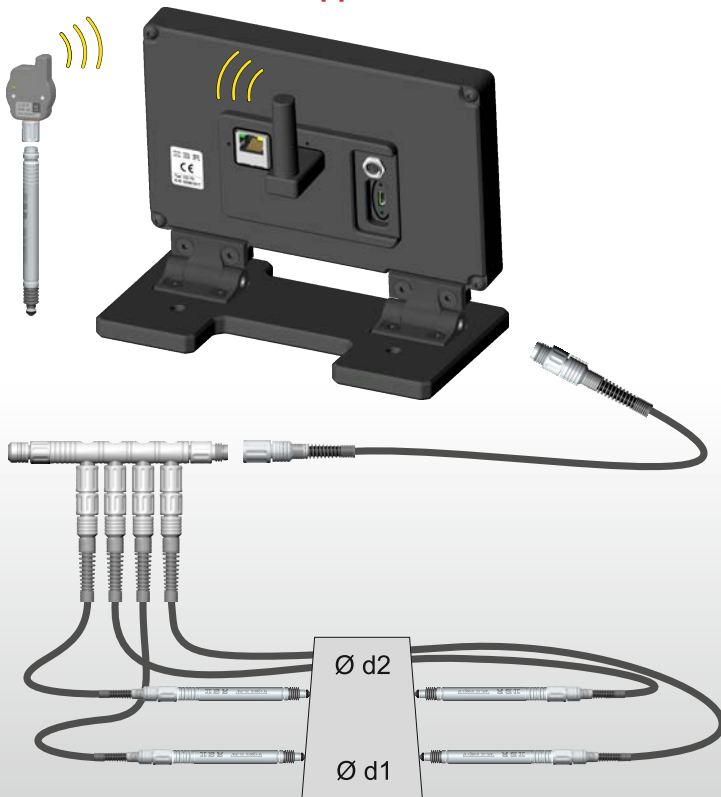

Technical data :

Mechanical characteristics	
Case with foot	Aluminium powder-coated
Dimensions / Weight	(WxHxD) 184 x 135 x 87.5 mm / 1.0kg
Protection class	Front side IP65, CEI / IEC 529 Rear side IP64 with connector caps
Electrical characteristics	
External power supply	100 ... 240 VAC, 6 Watt
Max. power consumption	2.4 Watt (without sensors)
Computer characteristics	
Display	7.0" TFT, resolution 800 x 480 (adjustable angle of tilt)
Touch Screen	4-wire analogue resistive
CPU	Vybrid VF50, 400 MHz
Memory	128 MB RAM, 128 MB Flash
Operating system	Windows CE 6
Measuring software	ComGage Level 1 / ComGage Level 2
Connections	
Standard PC connections	1x USB client, 1x USB host, 1x LAN
ISi interface	60 sensors / clients
Environmental conditions	
Operation / Storage temp.	+41 ... +113 °F / -4 ... +158 °F

ComGage Level 1 / Level 2

The software **ComGage Level 1 / Level 2** are universal programmes for fast solving of measuring applications. The software is easy to handle and is optimized especially for the computer displays CD43 and CD70 with touch operation.

Features

	ComGage Level 1	ComGage Level 2
Number of characteristics / Number of measuring inputs	8 / 60	20 / 60
Measurement of characteristics in freely definable groups with additional input of operator instructions	✓	✓
Input of formula for probe mixing (Support of all arithmetical and trigonometrical functions)	✓	✓
Static measuring mode with live display, as well as dynamic measuring modes : Min, Max, TIR, Mean, ...	✓	✓
Input of measuring value by touch / keyboard	✓	✓
Export functions for collected measuring values	xls, csv	xls, csv, QDAS
Reference information data input together with measuring values (Operator, Machine, ...)		✓
Trend display for collected measuring values (= run chart)	✓	✓
Statistical analysis by control charts, histograms, Cp/Cpk		✓
Control tasks by digital inputs / outputs as well as measuring value output via RS232 / radio modules	simple	advanced
Compatible to ComGage Professional	✓	✓

Image : Programming of characteristics

Select characteristic parameter group

Programme characteristic parameters

Image : Windows for data collection (Test sequence)

MEASURING > DATA COLLECTION > Please measure part in fixture
Test order: ART-9713 / Article: ART-9713 (Crank Shaft)

MEASURING > DATA COLLECTION > Please enter weight of part
Test order: ART-9713 / Article: ART-9713 (Crank Shaft)

MEASURING > Confirm measuring data of part
Test order: ART-9713 / Article: ART-9713 (Crank Shaft)

Characteristic	Unit	Target	Tolerance	Measured Value	Status
1 Diameter D23	mm	23.0000	0.0300 / -0.0300	23.0030	OK
2 Diameter D21	mm	21.0000	0.0300 / -0.0300	20.9960	OK
3 Diameter D21	mm	21.0000	0.0300 / -0.0300	21.0030	OK
4 Diameter D25	mm	25.0000	0.0300 / -0.0300	25.0030	OK
5 Diameter D25	mm	25.0000	0.0300 / -0.0300	24.9930	OK
6 Length	mm	50.0000	0.0300 / -0.0300	50.0100	OK
7 Weight	g	1200.0000	5.0000 / -5.0000	1205.1000	OK

Description of 1st window

In the test sequence 6 characteristics of the component are initially measured together in a measuring fixture. The operator receives the corresponding instructions via window headline.

Description of 2nd window

In the second step of the test sequence the operator must weigh the component and enter the measuring value by touch.

Description of 3rd window

In the last step of the test sequence the operator can see a complete summary of all characteristics of the measured component and can now decide, whether the measuring values shall be stored inside the database.

ComGage Level 1 / Level 2

Online -SPC windows



Run chart in ComGage Level 1 and Level 2

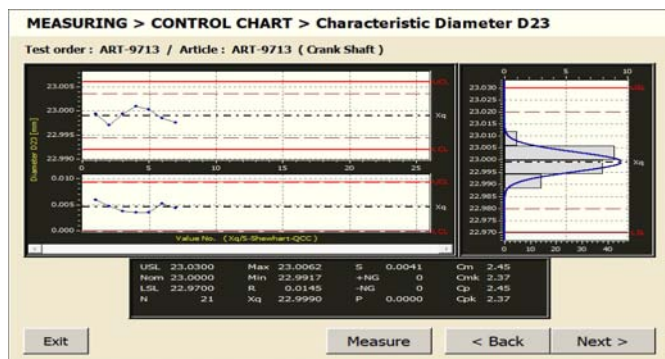

Control chart in ComGage Level 2

Administration, analysis and export of measured values by ComGage Professional

ComGage Professional allows creating test orders for test schemes created with ComGage Level 1 / 2. The test orders allow storage of measured data separately for production orders, production lots, ... and can be filled with measured data using ComGage Level 1 / 2.

The measured values collected with ComGage Level 1 / 2 can be exported or analysed using ComGage Professional afterwards.

Access to flash memory of CD43 / CD70 computer displays via USB

On connection of a CD43 / CD70 via USB client connector (Micro-USB) to a Windows PC, the flash memory of the CD43 / CD70 computer display can be directly accessed via Windows Mobile Device Center Software.

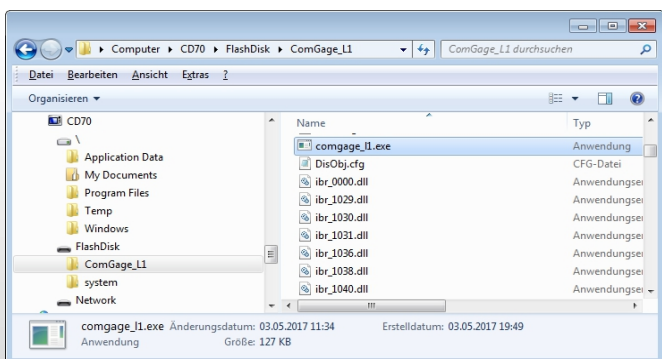

Programming of test schemes using ComGage Professional on PC

The ComGage Professional menu for programming test schemes allows to specify, that the new test scheme shall be executable with ComGage Level 1.

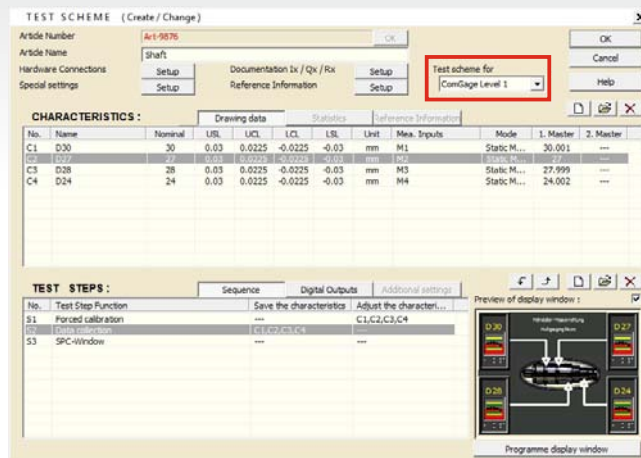

In contrast to the programming with ComGage Level 1 / 2, the programming menu of ComGage Professional allows programming of test steps with freely designable display windows and individual control of digital inputs / outputs.

For guiding the operator through the measuring sequence freely designable display windows can be created for ComGage Level 1 / 2. These display windows can contain pictures, lines and texts.

Step 1 : Add a display element

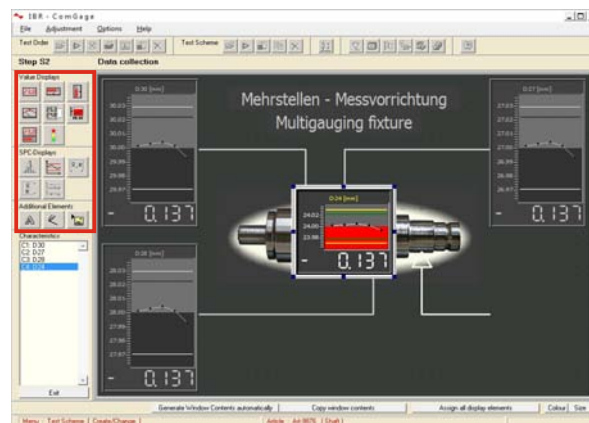

Step 2 : Place a display element



Software support

SD1_Win

SD1_Win Windows programme for configuration of SD1 sensor displays.

ISi_Test

ISi_Test is a universal program for initialisation, calibration and test of all ISi sensors.

IBR_DDK.DLL

Universal **D**evice **D**river **K**it for linking all IBR measuring and interface instruments in Win 2000 ... Win 10 and CE programs. (Examples for VC++, VB, LabView, Delphi, ... available)

IBR_VCP

COM-Port simulation program for software packages without USB, LAN and WLAN support. Simulation of older multiplexers (e.g. MUX50, MUX10, ...) for software packages without ISi-Bus, IMBus & ISM support.

IBREXDLL

Excel-Workbook for reading in, visualising and analysing measurement data in MS-Excel.

ComGage

Software for metrology and statistical process control in manufacturing facilities.

Head office of IBR Messtechnik GmbH & Co. KG



**WILLRICH PRECISION
I N S T R U M E N T**
THINK MEASUREMENT... THINK WILLRICH

Ph 866-945-5742 email:sales@willrich.com