



TOOL-A-THON

26.1



Celebrating our 80th Year!

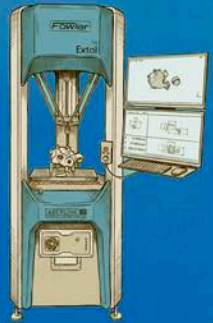
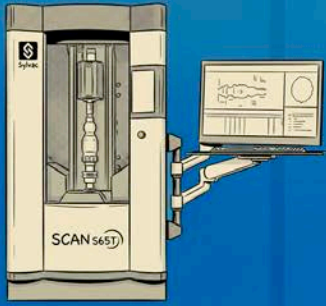
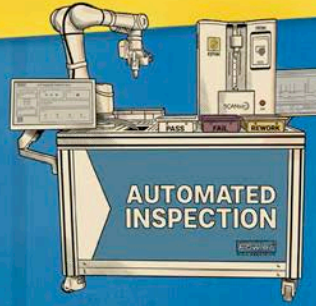

fowlerprecision.com

Tool-A-Thon pricing good from March 1, 2026-July 1, 2026

SPRINGFIELD HA



IMTS '76 - INTERNAT

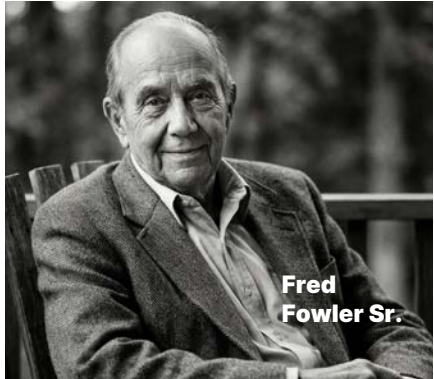
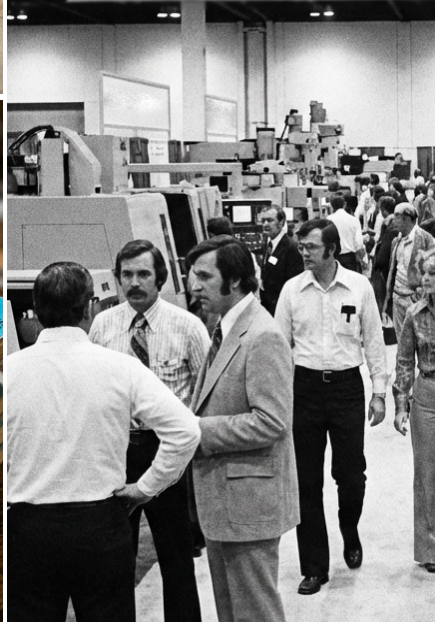

Fred Fowler Sr.

Fowler

TOOLS AND MEASURING INSTRUMENTS

In 1946, 42-year-old salesman Fred V. Fowler, Sr. stumbled onto something unexpected: local machine shops desperately needed quality brooms and brushes. What started as a humble supply business grew organically as Fred listened to his customers, gradually expanding into inspection tools and shop equipment, building trust one relationship at a time.

When his son Fred Jr. joined in 1959, he saw the future in precision. Calipers, micrometers, indicators and other shop tools were in high demand as American manufacturing surged after World War II. After buying out his father, Fred Jr. steered the company for over 50 years, transforming that broom business into a respected name in metrology. His father lived to witness it all—passing away in 2005 at 101, having seen his simple supply operation become something far greater.

The company's boldest transformation came in 2011, when Fred Jr. asked his daughter Cindy and son-in-law David Francis to take the reins. David didn't just expand the product line—he strategically cultivated relationships with innovative partners worldwide, carefully vetting technologies and building alliances that positioned Fowler at the leading edge of metrology. It was no small feat. Transforming a hand-tool company to include sophisticated precision systems required equal parts technical savvy and relationship-building finesse. Fred Jr. passed in 2012, but not before seeing his vision for the company's future take shape.

When Pfingsten Partners acquired Fowler in 2022, they were investing in nearly 80 years of hard-won expertise, and a company poised to reach new heights in precision manufacturing and quality control.

Only about 1 in 1,000 businesses make it to the 80-year mark. Today, we give thanks to the leaders who built this legacy, and to the customers and partners who've allowed us to stand among the 0.1% of companies that have made it this far.

Fowler remains nimble, responsive, and focused on what customers will need for the next 80 years. When you choose Fowler, you're partnering with a team that brings scrappy, customer-first DNA to every relationship.

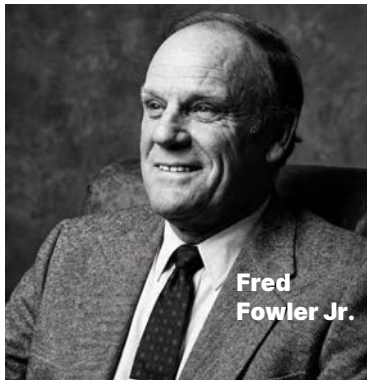

**Fred
Fowler Jr.**

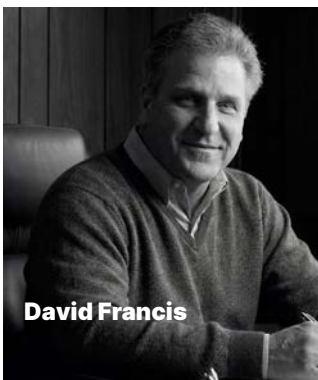

David Francis



Cindy Francis

Measur3D Manual CMM

A step up from Height Gages and Hand Tools

Captures complex geometries
for reverse engineering

Perfect for rapid first piece &
GD&T inspections on shop floor

ACCURACY
5 μ m

X & Y RANGE
280mm/11"

Z RANGE
150mm/5.9"

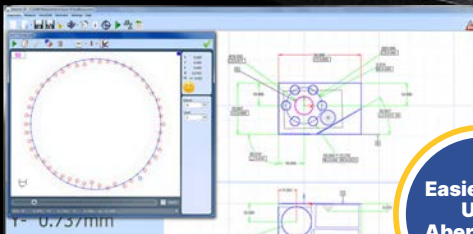

Easiest-to-Use
Aberlink3D
Software

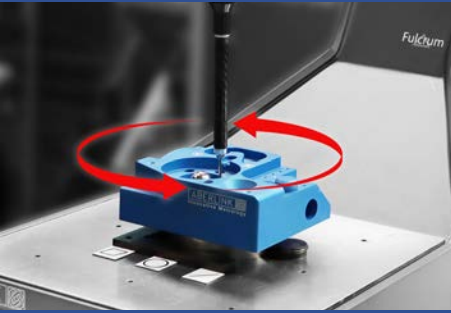

Star Styli Included for versatile 3D Measurement in any axis (X-Y-Z) ▾

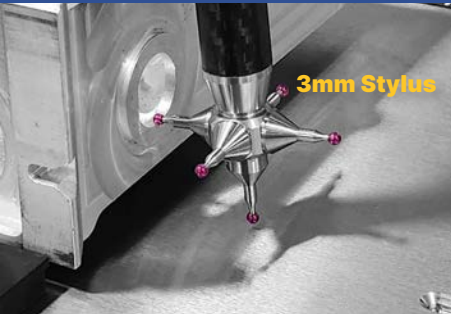

3mm Stylus



6mm Stylus

Models	Measur3D
Measuring volume (not cubic)	
Cylindrical (X)	11"/280mm
Cylindrical (Y)	11"/280mm
Cylindrical (Z)	5.9"/150mm
Dimensions	
Overall Width (X)	13.2"/335mm
Overall Height (Y)	32.7"/830mm
Overall Depth (Z)	28.5"/725mm
Volumetric Accuracy	5.0µm
Scale Resolution	1.15µrad
Optimum Temp. Range	18 - 22°C
Operational Temp. Range	5 - 45°C

Extol

Shop Floor CMM

Moving at speeds up to 750 millimeters per second

Rugged, delta-arm design is automation ready

Compact 28" Footprint

ACCURACY
2.6 μm

X & Y RANGE
370mm/14.5"

Z RANGE
270mm/10.6"



Shop-Floor Ready



No Air Required

Built for Automation

Technical Specifications

Models	EXT-370	EXT-520
Measuring range		
Cylindrical (X)	Dia. 14.5"/370mm	Dia. 20.4"/520mm
Cylindrical (Y)	Dia. 14.5"/370mm	Dia. 20.4"/520mm
Cylindrical (Z)	10.6"/270mm	11.8"/300mm
At Centre	14.3"/365mm	15.7"/400mm
Dimensions		
Overall Width (X)	28.1"/715mm	37.4"/950mm
Width Incl. Monitor (X)	39.3"/1000mm	46.4"/1180mm
Overall Depth (Y)	28.7"/730mm	38.9"/990mm
Depth Incl. Monitor (Y)	40.5"/1030mm	51.9"/1320mm
Overall Height (Z)	78.7"/2000mm	86.6"/2200mm
Height to Table (Z)	35.4"/900mm	30.4"/772mm
Total Weight	396 lbs./180kg.	464.2 lbs./211 kg.
Table Load Capacity	440 lbs./200 kg.	
Volumetric Accuracy	(2.6 + 0.4L/100)µm	
Scale Resolution	0.00001"/0.0001mm	
Operational Temp. Range	45°C	
Max. Acceleration Vector	750mm/sec ²	
Max. Velocity Vector	500mm/sec	

Axiom

Manual/CNC CMM

Bridge-style precision with a clear growth path

Teach & Repeat programming for easy and approachable automated inspections with CNC CMMs

Systems



Start
Manual

Upgrade
to CNC

**Teach
& Repeat
Programming**

**CMM Camera
Attachment**

**Lab-grade
Accuracy**

Technical Specifications

CNC/Manual	Manual 600	Manual 900	Manual 1200
Axis Travel			
X	25.2"/640mm	25.2"/640mm	25.2"/640mm
Y	23.6"/600mm	35.4"/900mm	47.2"/1200mm
Z	19.6"/500mm	19.6"/500mm	19.6"/500mm
Overall Size			
X	44.4"/1130mm	44.4"/1130mm	44.4"/1130mm
Y	35.4"/900mm	47.2"/1200mm	59.2"/1500mm
Z	91.3"/2320mm	91.3"/2320mm	91.3"/2320mm
Volumetric Accuracy			
TP20		(2.4 + 0.4L/100) μ m	
TP200		(2.3 + 0.4L/100) μ m	
SP25M		(2.1 + 0.4L/100) μ m	
Scale Resolution	0.0001mm (0.1 μ m)	0.0001mm (0.1 μ m)	0.0001mm (0.1 μ m)
Optimum Temp. Range		18 - 22°C	
Operational Temp. Range		0 - 45°C	
Air Consumption		50 l/min (1.8 cfm)	
Required Air Pressure	4 bar (60 psi)	4 bar (60 psi)	4 bar (60 psi)
Features			
Solid Granite Table	•	•	•
Honeycomb Aluminum and Granite Table	•	•	
CNC Models			
Speed		20% faster, 15% more accurate	
Max. Velocity Vector		600mm/sec	
Max. Acceleration Vector		600mm/sec ²	

zCAT Portable CMM

Teach & Repeat allows you to teach the zCAT what to do, then hit PLAY to reproduce your measurements. It's that simple.

Portability

means you can program it at your engineering desk, bring it to staff & hit play.

360° Rotation

means you or a robot can hot-swap parts to be measured.

3D
Measurements
on Shop Floor

ACCURACY
8 μ m

X & Y RANGE
700mm/28"

Z RANGE
250mm/9.8"



700mm Cylindrical Volume

**Hot-swap
parts during
inspection**



Technical Specifications

Models	zCAT
Measuring range	
Cylindrical (X)	27.6"/700mm
Cylindrical (Y)	27.6"/700mm
Cylindrical (Z)	9.8"/250mm
Dimensions	
Overall Width (X)	16.5"/420mm
Overall Height (Y)	24.4"/620mm
Overall Depth (Z)	6.8"/172mm
Total Weight	13.6kg./30 lbs
Accuracy	8.0µm
Speed	User controlled to 150 mmps

**Teach
& Repeat
Programming**

Systems

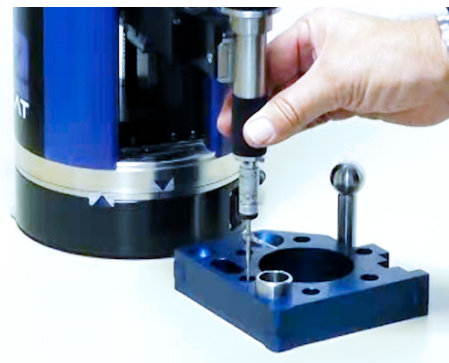

Fowler
HIGH PRECISION

Horizon

Our most accurate bridge-style CMM

- Innovative, frictionless linear drives for fast, smooth, silent motion
- Wear free parts for greater reliability
- 2204.6 lbs./1000 kg. table capacity

**Ideal for
Contact
Scanning**

**Auto-
changing
probes**

ACCURACY
up to 1.5 μm

X RANGE
up to
1000mm/39.4"

Y RANGE
up to
2000mm/78.7"

Z RANGE
up to
800mm/31.5"

Halo

- Cost-saving Belt Drive System for X-Y-Z Axis movement
- Suitable for the workshop environment
- Solid granite table with high load capacity
- 2204.6 lbs./1,000 kg. table capacity

ACCURACY
starting at
1.8 μm

X RANGE
up to
1000mm/39.4"

Y RANGE
up to
2000mm/78.7"

Z RANGE
up to
800mm/31.5"



***See CMM
Camera
Attachment
pg. 9**

Azimuth

- Our largest bridge CMM, utilizing a belt drive system
- Up to 13,200 lbs./6,000 kg. table capacity

ACCURACY
up to 2.6 μm

X RANGE
up to
1200mm/47.2"

Y RANGE
up to
3000mm/118.1"

Z RANGE
up to
1000mm/39.4"



SCAN S25T

Optical Line Scanning System, Perfect for Cylindrical & Threaded Components in a Compact Benchtop Design



Models	S25T
Measuring range	
Diameter	1.02"/26mm
Length	7.87"/200mm
Resolution	
Diameter	0.000001"/0.0001mm
Length	0.000001"/0.0001mm
Accuracy	
Diameter	(0.9 + D[mm]/100) μm
Length	(2.5 + D[mm]/200) μm
Repeatability	
Diameter	0.000016"/0.0004mm
Length	0.000031"/0.0008mm
Holding Capacity	
Diameter	2"/51mm
Length	7.87"/200mm
Maximum Part Weight	4.4 lbs./2 kg.
Machine Weight	132 lbs./60 kg.

Tilting

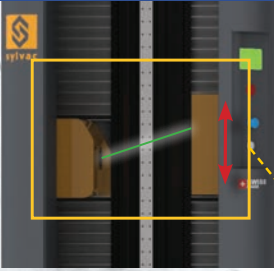

SCAN S65T

Tilting Optics: Exclusive Optics for Complete Thread Measuring – Non Algorithmic Thread Measurement

Complete measurement of threads

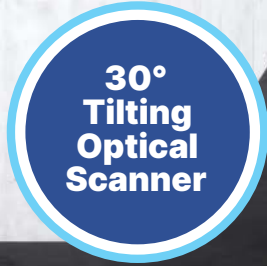

Systems

26.1

SCAN S145 Series

Blazing fast, super precise optical scanner for your Largest Parts

Attach the probe to any model for enhanced measurement and inspection

**Fastest
Inspection of
Turned Parts**

Systems

**360°
Rotational Axis
for Dynamic
Measurement**



Fowler
HIGH PRECISION

Bluetooth Connectivity • Automation Ready • Swiss-made

Probing

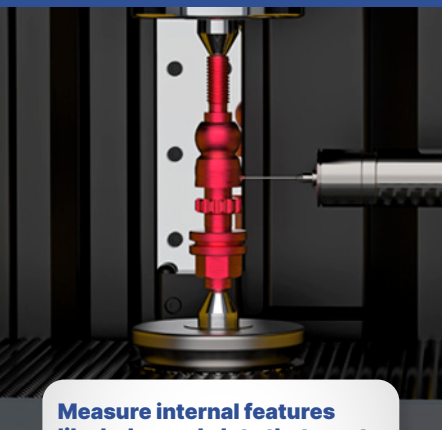

Measure internal features like holes and slots that most optical systems can't reach—all in one setup.

Rotational Axis



Dynamic measurement with rotating axis for maximum thread inspection.

Technical Specifications

Models	S145	S145L	S145XL
Measuring range			
Diameter	5.7"/145mm	5.7"/145mm	5.7"/145mm
Length	24.2"/615mm	50.3"/1280mm (48.4"/1230mm with probe)	70.9"/1800mm (68.9"/1750mm with probe)
Resolution)			
Diameter		0.0001mm	
Length		0.001mm	
Accuracy			
Diameter		(1.5 + D/100 μm)	
Length		(4 + L/200 μm)	
Repeatability			
Diameter		0.5μm	
Length		1.0μm	
Holding Capacity			
Diameter		10"/254mm (7.9"/200mm w/3D probe)	
Length	24.2"/615mm	50.3"/1280mm	70.9"/1800mm
Maximum Part Weight		200 lbs./100 kg.	
Machine Weight		1168 lbs./530 kg.	1757 lbs./797 kg.
Axial Positioning Speed		Up to 160mm/s (Up to 20mm/s with probe)	
Measuring Volume of Probe*		PX: 615/PY: +60, -40/PZ: +130, -15	PX: 1230/PY: +60, -40/PZ: +130, -15
		PX: 1750/PY: +60, -40/PZ: +130, -15	

26.1

Systems

Venture XT 3030

Advanced multi-sensor 3D measurement platform delivering optical and tactile capability

Comprehensive GD&T analysis and reporting

4-in-1
Multi-Sensor
System

Camera,
Touch Probe,
Manual Cross
Hair & Digital
Microscope

Fowler
HIGH PRECISION

Bluetooth Connectivity • Automation Ready

Venture FV

- 3D measurement
- Instant measurements at the push of a button
- CNC rotary indexing allows cylindrical parts to be rotated and measured multiple times per revolution
- Double telecentric optics for high resolution 3D measurement
- All have easy-to-use Fowler FUSION software
- Motorized auto focus

**100s of
dimensions on
100s of parts in
seconds**

**Measure
with the press
of a button**



Optical Comparators



- All feature profile and surface illumination
- Most models with optical edge detection
- Available with up to 24" screen
- Choice of readouts including touch screen powered by Fowler FUSION software
- Made in England



HS Series

Horizontal Setting Benches

Available
motorized
or non-
motorized

Large selection
of accessories to
handle any job



Models	HS4	HS5	HS6
Measuring range	550mm/20", 1050mm/40", 1550mm/60", 2050mm/80", or 3050mm/120"		
Measuring force	15 N		3 N
Max. Permissible Errors	0.7+L (mm)/1000 μ m		
Repeatability	0.5 μ m		0.2 μ m
Max. Resolution	0.0001mm/0.00001"		
Max. Displacement Speed	1500mm/s		
Operating Temp.	+10 \div +40 $^{\circ}$ C		

THV Horizontal Measuring System

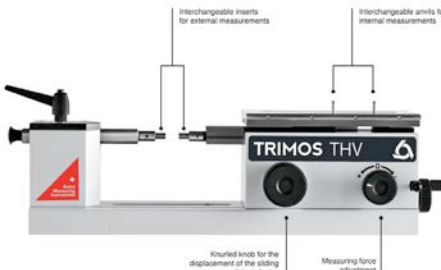

Our
Best Selling
Horizontal
Calibration
Bench

Horizontal Calibration

For calibration, measuring, and setting

- Calibrate plugs, rings, threads and much more
- Set ID/OD gages, bar gages, swing gages
- Ranges up to 40"/1000mm
- Meets ISO 9000/2000 standards

*Please note: Calibration benches available up to 118"/3000mm and setting benches available up to 315"/8000mm



Calibration of Plain Rings

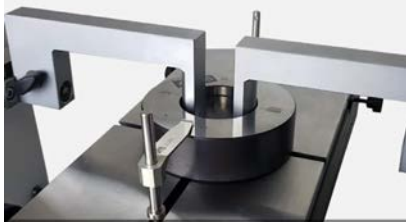

Calibration of Threaded Plugs



Models	HC3	HC4	HC5
Measuring range			
300	-	-	13"/350mm
500	20"/550mm	20"/550mm	20"/550mm
1000	40"/1050mm	40"/1050mm	40"/1050mm
1500	60"/1550mm	60"/1550mm	-
2000	80"/2050mm	80"/2050mm	-
3000	120"/3050mm	120"/3050mm	-
Max. Permissible Errors	0.6+L(mm)/1200 μm	0.3+L(mm)/2000 μm	0.15+L/2000 μm* *Note: 0.1+L/2000 μm for 300
Repeatability	0.1 μm		0.05 μm
Max. Resolution	0.0001mm		0.00001mm
Max. Displacement Speed	4000mm/s		
Operating Temp.	+10 ÷ +40 °C		
Relative humidity	20 ÷ 80 %		



Models	Hi_CAL 150	Hi_CAL 300	Hi_CAL 450	V1	V1+
Measuring range					
150mm/6"	•				
300mm/12"		•		•	•
400mm/16"					
450mm/17.5"			•		
611mm/24"				•	•
700mm/28"					
1100mm/43"					
1800mm/71"					
add 312mm/12" of application range w/ 2nd probe holder					
Precision	2.0 + L/200 μm	2.0 + L/200 μm	2.0 + L/200 μm	1-3μm	1.5-2.5μm
Repeatability	2 μm	2 μm	2 μm	0.01mm	0.005mm
Max Resolution mm	0.001mm	0.001mm	0.001mm	0.01mm	0.001mm
"Black Mask" Display (1D)					
Touch Color Display (2D)					
Min/Max/Delta					
Avg, Difference					
Heights, Diameters, Centerline distance	•	•	•		•
SmartReverse (Smart diameter measurement)					
Perpendicularity w/ lever indicator					
Perpendicularity w/ electronic probe					
Angles & Cones					
Temperature Compensation					
Works on battery				•	•
Manual Movement					
Motorized Movement	•	•	•		
Air Cushion					
Fine Adjustment	•	•	•		
Long Probes (400mm)					
9 References					
2D Mode					
Tolerances					
Calculation Function					
Programs					
Statistics					
Wireless Data Transfer (option)	•	•	•		
USB & RS232 Interface	•	•	•		

V1-V9 Series Electronic Height Gages

Over 40 years of recognized excellence!

High accuracy, manual or motorized

See the full comparison chart of all our electronic height gages on pg. 20-21



Certify Any Height Gage Below For Only **\$299.00**

Valid only for Tool-A-Thon 26.1

26.1



54-192-340-0



54-199-570-0



54-199-770-0

Order No.	Measuring Range	Range with Probe Inverted	List Price	Sale Price
V3				
54-192-340-0	16"/407mm	20"/508mm	\$7,596.00	\$7,217.00
54-192-370-0	28"/711mm	31.9"/812mm	\$8,515.00	\$8,091.00
V4				
54-191-440-0	16"/407mm	28.3"/719mm	\$9,469.00	\$8,996.00
54-191-470-0	28"/711mm	40.2"/1023mm	\$11,069.00	\$10,517.00
V4+				
54-191-440-2D	16"/407mm	28.3"/719mm	\$12,443.00	\$11,822.00
54-191-470-2D	28"/711mm	40.2"/1023mm	\$13,483.00	\$12,810.00
V5				
54-199-540-0	16"/407mm	28.3"/719mm	\$9,916.00	\$9,421.00
54-199-570-0	28"/711mm	40.2"/1023mm	\$11,516.00	\$10,941.00
54-199-590-0	43.7"/1110mm	56"/1422mm	\$17,820.00	\$16,930.00
V7				
54-199-740-0	16"/407mm	28.3"/719mm	\$15,926.00	\$15,130.00
54-199-770-0	28"/711mm	40"/1023mm	\$17,013.00	\$16,163.00
Probe Sets				
54-199-105-0	4mm Probe Set, 21 piece		\$2,561.00	\$2,433.00
54-199-106-0	8mm Probe Set, 16 piece		\$2,073.00	\$1,970.00
54-199-107-0	8mm Basic Probe Set, 7 piece		\$751.00	\$714.00
Accessories				
54-199-400-0	Ø8mm Ceramic Probe Holder L=400mm		\$1,555.00	\$1,478.00

Prices & Specifications are subject to change without notice.

25

Height Gages



Fowler Sylvac Hi_Cal V2 Electronic Height Gages

For your finer, more delicate parts.

Features:

- Bluetooth for quick, easily recorded measurements
- Extra low measuring force, from 0.2N
- Measure internal and external diameters, centerlines, heights, widths, depths and MIN/MAX/TIR capability
- Battery life: 40 hours rechargeable during operation
- Touch sensitive probe speed for easy operation
- Base with small footprint

**ISO Certification available
for \$199.00 extra!**



54-931-150-BT

All models Include:

- Protective cover
- Ruby ball probe Ø3mm
- Setting gage
- Calibration certificate



54-931-300-BT



54-931-450-BT



54-930-217-0

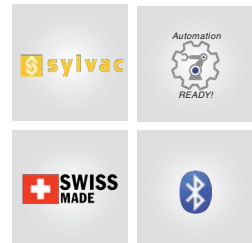

Order No.	Range	Accuracy	List Price	Sale Price
54-931-150-BT	6"/150mm	0.00013"/0.0034mm	\$7,172.00	\$6,815.00
54-931-150-BT-C	6"/150mm with ISO/A2LA Certification		\$7,380.00	\$7,011.00
54-931-300-BT	12"/300mm	0.00016"/0.0042mm	\$7,865.00	\$7,472.00
54-931-300-BT-C	12"/300mm with ISO/A2LA Certification		\$8,106.00	\$7,701.00
54-931-450-BT	17.5"/450mm	0.00020"/0.005mm	\$8,928.00	\$8,483.00
54-931-450-BT-C	17.5"/450mm with ISO/A2LA Certification		\$9,074.00	\$8,621.00
Accessories				
54-930-217-0	Standard Probe Accessory Kit, 5 Piece		\$1,268.00	\$1,205.00
54-930-215-0	Full Probe Accessory Kit, 15 Piece		\$3,477.00	\$3,304.00

26

Prices & Specifications are subject to change without notice.

NEW V1 & V1+ Electronic Height Gages

Introducing the next generation of Trimos entry-level height gages for the workshop.

Features:

- Accuracy: 0.0012"/0.03mm
- Bluetooth/RS232 data output
- Steel base and extra large display with simplified keypad
- V1 features a fine adjust hand-wheel for scribing (scraper included)
- V1+ features bi-directional measuring force hand-wheel for measuring bores, centerlines, heights, MIN/MAX/TIR
- Supplied with 0.236"/6mm ball probe
- Granite base units available as special order



54-180-524-5



Order No.	Description	Range	Resolution	List Price	Sale Price
54-180-424-0	V1	24"/611mm	0.001"/0.01mm	\$4,393.00	\$4,174.00
54-180-512-0	V1+	12"/300mm	0.0001"/0.001mm	\$4,686.00	\$4,452.00
54-180-512-5	V1+ with granite base	12"/300mm	0.0001"/0.001mm	\$5,418.00	\$5,148.00
54-180-524-0	V1+	24"/611mm	0.0001"/0.001mm	\$5,857.00	\$5,565.00
54-180-524-5	V1+ with granite base	24"/611mm	0.0001"/0.001mm	\$6,589.00	\$6,260.00

Z-HEIGHT Height Gage

With handwheel and fine adjust.

Features:

- Base design has a more comfortable grip and is finely ground and lapped for smooth movement on surface plates
- Fine adjust feature allows precise adjustment to required settings
- Indicator holding bar included

Calibration certificate available.



Z-HEIGHT ABS PLUS+ Height Gage

Features:

- True ABS measuring system
- Supplied with a NIST certified test block (1" x 2" x 3")
- Large handwheel for both coarse and fine adjustments
- Carbide scriber
- Positive locking lever for scribing

Calibration certificate available.



Order No.	Range	Accuracy	Resolution	List Price	Sale Price
54-175-012-0	0-12"/300mm	± 0.0015"/0.04mm	0.0005"/0.01mm	\$882.00	\$794.00
54-175-018-0	0-18"/500mm	± 0.002"/0.05mm	0.0005"/0.01mm	\$864.00	\$779.00
54-175-012-1	0-12"/300mm	± 0.0015"/0.04mm	0.0005"/0.01mm	\$864.00	\$778.00

Fowler Bowers Bluetooth

For special application heads, contact the
Fowler Technical Department 1-800-788-2353

2" - 4" Set



54-567-100-BT



XTH3 Bluetooth HOLEMATIC Pistol Grips

Features:

- Coolant proof, dust proof - IP67
- Resolution: 0.00005"/0.001mm
- Bluetooth connectivity to your phone or tablet
- Accuracies: 0.00015" - 0.00035"/0.004mm - 0.009mm
- Tungsten carbide measuring faces on all 3-point heads from 0.5"/12.5mm and up
- Sizes over 0.500"/12.5mm feature blind bore capability
- Includes UKAS certificates for all pistol grip, heads and rings
- Additional individual sizes available

Order No.	Range	Includes	List Price	Sale Price
Pistol Grip Complete Sets				
54-567-009-BT	0.080" - 0.250"/2 - 6mm (2 pt.)	5 heads, 1 handle, 3 rings	\$7,737.00	\$6,964.00
54-567-010-BT	0.250" - 0.375"/6 - 10mm	2 heads, 1 handle, 1 ring	\$3,034.00	\$2,731.00
54-567-020-BT	0.375" - 0.750"/10 - 20mm	3 heads, 1 handle, 2 rings	\$3,550.00	\$3,195.00
54-567-050-BT	0.750" - 2"/20 - 50mm	3 heads, 1 handle, 2 rings	\$4,583.00	\$4,125.00
54-567-100-BT	2" - 4"/50 - 100mm	3 heads, 1 handle, 2 rings	\$5,101.00	\$4,591.00
54-567-105-BT	4" - 6"/100 - 150mm	2 heads, 1 handle, 1 ring	\$4,583.00	\$4,125.00
54-567-110-BT	6" - 8"/150 - 200mm	2 heads, 1 handle, 1 ring	\$6,049.00	\$5,445.00
54-567-200-BT	4" - 8"/100 - 200mm	4 heads, 1 handle, 2 rings	\$9,575.00	\$8,618.00
54-567-210-BT	0.750" - 4"/20 - 100mm	6 heads, 1 handle, 4 rings	\$6,618.00	\$5,957.00
54-567-620-BT	0.250" - 0.750"/6 - 20mm	5 heads, 1 handle, 3 rings	\$4,095.00	\$3,686.00
Connectivity Cables/Accessory				
54-115-526-0	Proximity cable with USB connection		\$251.00	\$226.00
54-115-527-0	Proximity cable with serial connection 24"/611mm		\$294.00	\$266.00
54-115-246-BT	USB bluetooth receiver		\$58.00	\$53.00

Extensions

Order No.	Length	Diameter	Fits Heads	List Price	Sale Price
54-336-301-0	2.5"/63mm	0.230"	0.250"-0.375"/6-10mm	\$194.00	\$175.00
54-336-302-0	3"/76mm	0.366"	0.375"-0.500"/10-12.5mm	\$194.00	\$175.00
54-336-303-0	4"/100mm	0.479"	0.500"-0.750"/12.5-20mm	\$194.00	\$175.00
54-336-304-0	6"/150mm	0.740"	0.750" - 2"/20 - 50mm	\$296.00	\$267.00
54-336-306-0	20"/500mm	0.757"	0.750" and higher	\$999.00	\$900.00
54-336-307-0	40"/1000mm	1.365"	1.375" and higher	\$1,480.00	\$1,332.00

Bore Gaging Systems

For special application heads, contact the
Fowler Technical Department 1-800-788-2353

XTD3 Bluetooth Electronic Holemikes

3/8" - 3/4" Set



54-367-020-BT

2 Point Spherical



2 and 3 Point Grooves



3 Point Spherical



Ball Screw Threads



2 and 3 Point Screw Threads



Ball Race Measurement



Internal Spline



Slot Width



Order No.	Range	Includes	List Price	Sale Price
Holemike Complete Sets (Traditional style)				
54-367-000-BT	0.080" - 0.250"/2 - 6mm (2 pt.)	5 heads, 1 handle, 3 rings	\$6,252.00	\$5,627.00
54-367-010-BT	0.250" - 0.375"/6- 10mm	2 heads, 1 handle, 1 ring	\$2,938.00	\$2,645.00
54-367-020-BT	0.375" - 0.750"/10 - 20mm	3 heads, 1 handle, 2 rings	\$3,506.00	\$3,156.00
54-367-050-BT	0.750" - 2"/20 - 50mm	3 heads, 1 handle, 2 rings	\$4,759.00	\$4,284.00
54-367-100-BT	2" - 4"/50 - 100mm	3 heads, 1 handle, 2 rings	\$5,272.00	\$4,745.00
54-367-105-BT	4" - 6"/100 - 150mm	2 heads, 1 handle, 1 ring	\$4,200.00	\$3,780.00
54-367-110-BT	6" - 8"/150 - 200mm	2 heads, 1 handle, 1 ring	\$5,539.00	\$4,986.00
54-367-200-BT	4" - 8"/100 - 200mm	4 heads, 1 handle, 2 rings	\$9,166.00	\$8,250.00

Connectivity Cables/Accessory

54-115-526-0	Proximity cable with USB connection		\$251.00	\$226.00
54-115-527-0	Proximity cable with serial connection	24"/611mm	\$294.00	\$266.00
54-115-246-BT	USB bluetooth receiver		\$58.00	\$53.00

Extensions

Order No.	Length	Diameter Fits Heads		List Price	Sale Price
54-336-301-0	2.5"/63mm	0.230"	0.250"-0.375"/6-10mm	\$194.00	\$175.00
54-336-302-0	3"/76mm	0.366"	0.375"-0.500"/10-12.5mm	\$194.00	\$175.00
54-336-303-0	4"/100mm	0.479"	0.500"-0.750"/12.5-20mm	\$194.00	\$175.00
54-336-304-0	6"/150mm	0.740"	0.750" - 2"/20 - 50mm	\$296.00	\$267.00
54-336-306-0	20"/500mm	0.757"	0.750" and higher	\$999.00	\$900.00
54-336-307-0	40"/1000mm	1.365"	1.375" and higher	\$1,480.00	\$1,332.00

Prices & Specifications are subject to change without notice.

XT-Series Holemikes

Vernier Bore Micrometers



Features:

- 3-pt contact with tungsten carbide measuring anvils above 0.5"
- Blind bore measuring heads featured above 0.5"
- Ratchet stop for consistent measuring
- Extensions available for deep measuring
- Includes UKAS certificates for all Holemikes and setting rings

Order No.	Range	Grads	Measuring Accuracy	Measuring Depth	Ring Included	List Price	Sale Price
52-255-310-0	0.250" - 0.312"	0.00025"	0.00015"	2.28"	0.312"	\$912.00	\$821.00
52-255-311-0	0.312" - 0.375"	0.00025"	0.00015"	2.28"	0.312"	\$845.00	\$761.00
52-255-312-0	0.375" - 0.500"	0.00025"	0.00015"	2.28"	0.5"	\$845.00	\$761.00
52-255-313-0	0.500" - 0.625"	0.00025"	0.00015"	2.44"	0.5"	\$877.00	\$790.00
52-255-314-0	0.625" - 0.750"	0.00025"	0.00015"	2.44"	0.75"	\$926.00	\$835.00
52-255-315-0	0.750" - 1"	0.00025"	0.00015"	2.60"	0.75"	\$952.00	\$857.00
52-255-316-0	1" - 1.375"	0.00025"	0.00015"	2.60"	1.375"	\$1,356.00	\$1,221.00
52-255-317-0	1.375" - 2"	0.00025"	0.00015"	3.15"	1.375"	\$1,388.00	\$1,250.00
52-255-318-0	2" - 2.625"	0.00025"	0.0002"	3.15"	2.625"	\$1,655.00	\$1,490.00
52-255-319-0	2.625" - 3.250"	0.00025"	0.0002"	3.15"	2.625"	\$1,670.00	\$1,503.00
52-255-320-0	3.250" - 4"	0.00025"	0.0002"	3.94"	3.25"	\$2,084.00	\$1,876.00
52-255-321-0	4" - 5"	0.00025"	0.00025"	4.53"	5"	\$2,173.00	\$1,956.00
52-255-322-0	5" - 6"	0.00025"	0.00025"	4.53"	5"	\$2,521.00	\$2,269.00

Sets

52-255-565-0	0.250" - 0.375"	2 heads, 2 handles, 1 ring				\$1,855.00	\$1,670.00
52-255-665-0	0.375" - 0.750"	3 heads, 3 handles, 2 rings				\$2,346.00	\$2,113.00
52-255-775-0	0.750" - 2"	3 heads, 3 handles, 2 rings				\$3,624.00	\$3,262.00
52-255-890-0	4" - 6"	2 heads, 2 handles, 1 ring				\$3,560.00	\$3,205.00
52-255-900-0	6" - 8"	2 heads, 2 handles, 1 ring				\$5,410.00	\$4,869.00

XTENDER- PLUS+ Bore Gage Set

Our two most popular bore gage ranges combined in one easy-to-use electronic set!

Preset size of master for absolute reading and use minimum hold feature to lock on the bore size as the gage is rocked in the part to be measured.

• Fitted with a Sylvac Lifetime Warranty electronic indicator (54-530-535-0)

- Range: 1.4 - 6"
- Analog scale for reversal point detection
- IP54 rated indicator
- Carbide tipped anvils
- Min/Max/TIR readings
- Supplied in a fitted case

Check out the Bore Gage Setting Master Kits on pg. 59



Order No.	Range	Resolution	Indicator Accuracy	List Price	Sale Price
54-646-535-0	1.4 - 6"/35 - 150mm	0.00005"/0.001mm	0.00012"/0.003mm	\$949.00	\$855.00

Internal & External Electronic Caliper Gages

For grooves and recesses



54-554-611-0



54-554-711-0

Features:

- Accuracy: $\pm 0.0008"/\pm 0.02\text{mm}$
- Resolution: $0.0002"/0.005\text{mm}$
- Analog scale for reversal point indication
- Large, LCD display
- Preset capability

- Absolute and incremental measurements modes
- High-impact, aircraft aluminum case
- Rugged housing

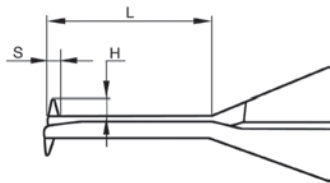

Dimensions for Internal Calipers

Metric	Inch	L	S	H	Tip Radius
5-15mm	0.2-0.6"	20mm	1.0mm	1.5mm	0.3mm
5-25mm	0.2-1.0"	35mm	1mm	1.5mm	0.3mm
10-30mm	0.4-1.2"	55mm	2mm	3.5mm	0.5mm
20-40mm	0.8-1.6"	80mm	3mm	6.5mm	0.5mm
30-50mm	1.2-2.0"	80mm	3mm	8.5mm	0.5mm

Dimensions for External Calipers

Metric	Inch	L	S	H	Tip Radius
0-10mm	0-0.4"	40mm	3mm	8mm	0.5mm
0-20mm	0-0.8"	80mm	6.5mm	25mm	0.75mm
10-30mm	0.4-1.2"	80mm	6.5mm	25mm	0.75mm
20-40mm	0.8-1.6"	80mm	6.5mm	25mm	0.75mm
30-50mm	1.2-2.0"	80mm	6.5mm	25mm	0.75mm

Order No.	Range	List Price	Sale Price
Internal Caliper Gages			
54-554-611-0	0.200" - 0.590"/5 - 15mm	\$220.00	\$199.00
54-554-622-0	0.200" - 1"/5 - 25mm	\$315.00	\$284.00
54-554-623-0	0.400" - 1.2"/10 - 30mm	\$281.00	\$253.00
54-554-624-0	0.790" - 1.6"/20 - 40mm	\$309.00	\$279.00
54-554-625-0	1.2" - 2"/30 - 50mm	\$296.00	\$267.00
External Caliper Gages			
54-554-711-0	0 - 0.400"/0 - 10mm	\$231.00	\$208.00
54-554-722-0	0 - 0.790"/0 - 20mm	\$252.00	\$227.00
54-554-723-0	0.4" - 1.2"/10 - 30mm	\$309.00	\$279.00
54-554-724-0	0.790" - 1.6"/20 - 40mm	\$402.00	\$362.00
54-554-725-0	1.2" - 2"/30 - 50mm	\$270.00	\$243.00

Dial Cylinder Bore Gages

2-point bore measuring



Features:

- Carbide Anvils
- Easy-to-read
- Great value
- Graduation: $0.00005"/0.001\text{mm}$
- Accuracy: $0.0006"/0.015\text{mm}$
- Insulated grip
- 9.5" depth above 1.5"
- Chrome plated handle
- 1.4" - 6" model available with an electronic indicator

54-646-401-0



52-646-400-0

Order No.	Range	Graduation	Accuracy	List Price	Sale Price
54-646-401-0	1.4 - 6"/35 - 150mm	0.001mm	0.015mm	\$378.00	\$322.00
52-646-100-0	0.7" - 1.5"	0.0005"	0.0009"	\$178.00	\$152.00
52-646-220-0	35 - 160mm	0.01mm	0.02mm	\$322.00	\$274.00
52-646-300-0	2" - 6"	0.0005"	0.0009"	\$167.00	\$142.00
52-646-400-0	1.4" - 6"	0.0005"	0.0009"	\$228.00	\$195.00
52-646-500-0	1.4" - 6"	0.0001"	0.0005"	\$329.00	\$280.00

Prices & Specifications are subject to change without notice.

Swiss Ultralight IV Electronic Calipers



Available Up to
2.5m range

When you have
HUGE
parts to measure,
this is the caliper
you need!

Features:

- IP67 protected against fluid and dust
- Built-in Bluetooth
- Reinforced frame
- XXL display with 0.79"/20mm high digits
- Lengthened jaws 7.9"/200mm
- Includes upper ID measuring pins (5mm dia.)
- Movable left jaw
- Stainless steel titanium coated jaws
- Hold feature
- Preset function
- Min/Max functions
- Tolerance mode
- Internal and external measurement indicator

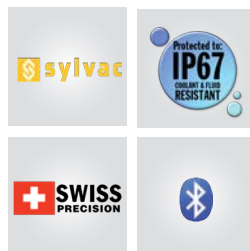

Alternative jaws available, contact the Fowler Technical Department for more information 1-800-788-2353

Order No.	Range	Accuracy	List Price	Sale Price
54-110-512-0	0 - 15"/0 - 400mm	0.0012"/30 µm	\$3,500.00	\$3,326.00
54-110-524-0	0 - 24"/0 - 600mm	0.0016"/40 µm	\$4,000.00	\$3,801.00
54-110-540-0	0 - 40"/0 - 1000mm	0.002"/50 µm	\$4,700.00	\$4,466.00

Connectivity Cables/Accessories

54-981-724-5	Sylcom Pro (digital license)	\$2,585.00	\$2,457.00
54-981-713-2	Sylcom Standard (dongle license)	\$1,102.00	\$1,047.00
54-115-526-0	Proximity cable with USB Connection	\$251.00	\$226.00
54-115-527-0	Proximity cable with Serial Connection	\$294.00	\$266.00
54-115-246-BT	USB Bluetooth Receiver	\$58.00	\$53.00

The Top 6 Reasons

This is the best caliper value on the market



1. Worry-free lifetime warranty
2. Fully integrated bluetooth, no additional equipment needed
3. IP67 for harsh & hard-working environments
4. Competitively priced versus other major brands
5. Operator friendly data collection software
6. Swiss precision & quality

More features

- Reinforced frame (3.5mm)
- XL display with 11.5mm digits
- Hold feature
- Preset function
- Available with ISO Cert
- 12"/300mm is supplied without depth rod

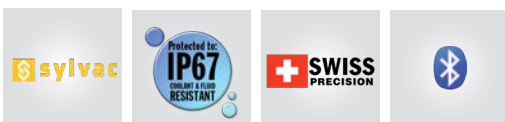
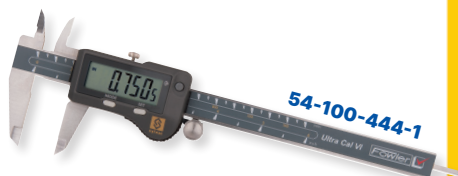

Calipers

Order No.	Range	Accuracy	Resolution	List Price	Sale Price
Bluetooth Built-in					
54-100-167-0	6"/150mm	0.0008"/20µm	0.0005"/0.01mm	\$540.00	\$514.00
54-100-168-0	8"/200mm	0.0012"/30µm	0.0005"/0.01mm	\$670.00	\$637.00
54-100-169-0	12"/300mm	0.0012"/30µm	0.0005"/0.01mm	\$860.00	\$818.00
Proximity Cable Communication					
54-100-444-1	6"/150mm	0.0008"/20µm	0.0005"/0.01mm	\$250.00	\$238.00
54-100-448-1	8"/200mm	0.0012"/30µm	0.0005"/0.01mm	\$350.00	\$333.00
54-100-412-1	12"/300mm	0.0012"/30µm	0.0005"/0.01mm	\$500.00	\$476.00
Without Data Output					
54-100-177-0	6"/150mm	0.0008"/20µm	0.0005"/0.01mm	\$230.00	\$219.00
54-100-178-0	8"/200mm	0.0012"/30µm	0.0005"/0.01mm	\$509.00	\$484.00
54-100-179-0	12"/300mm	0.0012"/30µm	0.0005"/0.01mm	\$587.00	\$558.00
Connectivity Cables/Accessories					
54-981-724-5	Sylcom Pro (digital license)			\$2,585.00	\$2,457.00
54-981-713-2	Sylcom Standard (dongle license)			\$1,102.00	\$1,047.00
54-115-526-0	Proximity cable with USB Connection			\$251.00	\$226.00
54-115-527-0	Proximity cable with Serial Connection			\$294.00	\$266.00
54-115-246-BT	USB Bluetooth Receiver			\$58.00	\$53.00

Prices & Specifications are subject to change without notice.

Micron 0.0005" Electronic Caliper

HIGH Resolution and HIGH Accuracy

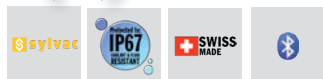

Features:

- Bluetooth connectivity
- High resolution: 0.0005"/0.001mm
- Accuracy up to 4": 0.0006"/0.015mm
- Accuracy above 4": 0.0012"/0.03mm
- Heavy duty frame (3.5mm)

Order No.	Range	List Price	Sale Price
54-100-100-0	0 - 6"/150mm	\$570.00	\$542.00

Accessory

54-115-246-BT	USB Bluetooth Receiver	\$58.00	\$53.00
---------------	------------------------	---------	---------

IP67 Electronic Calipers

Smart Wireless Communication to most phones or tablets



54-100-556-BT

Features:

- IP67 protected against fluid and dust
- Wireless connectivity for quick error free data collection
- Supplied with NIST certification
- Heavy duty frame with 4-way measuring, inside, outside, depth and step
- Includes extra battery tray and a 1" setting standard



Order No.	Range	Accuracy	List Price	Sale Price
54-100-556-BT	0 - 6"/150mm	0.001"/0.02mm	\$245.00	\$221.00
54-100-512-BT	0 - 12"/300mm	0.0015"/0.04mm	\$315.00	\$284.00

XTRA-VALUE^{Plus} Electronic Calipers

IP54 protected with inch/metric/fractions



54-103-006-0

Features:

- Inch/Metric/Fraction reading: 0.0005"/0.01mm/ 1/128"
- Heavy Duty frame for extra rigidity and wear resistance
- Super large, easy to read display



Order No.	Range	Accuracy	List Price	Sale Price
54-103-006-0	0 - 6"/150mm	0.001"/0.02mm	\$97.00	\$88.00
54-103-012-0	0 - 12"/300mm	0.0015"/0.04mm	\$196.00	\$178.00

XTRA-VALUE CAL Electronic Calipers

26.1



54-101-150-2



54-101-300-1



Features:

- Stainless steel frame
- Resolution: 0.0005"/0.01mm
- Absolute/Incremental measurement
- 4-way measuring, inside, outside, depth and step
- 6" and 12" regular display models include NIST Cert.

Order No.	Range	Display	Accuracy	List Price	Sale Price
54-101-150-2	0 - 6"/150mm	Regular Display	0.001"/0.02mm	\$70.00	\$63.00
54-101-600-1	0 - 6"/150mm	Large Display with Hold feature	0.0015"/0.04mm	\$80.00	\$72.00
54-101-200-1	8"/200mm	Regular Display	0.0015"/0.04mm	\$120.00	\$108.00
54-101-300-1	12"/300mm	Regular Display	0.0015"/0.04mm	\$200.00	\$180.00
54-101-900-1	12"/300mm	Large Display with Hold feature	0.0015"/0.04mm	\$184.00	\$166.00

Internal and External Calipers

Add greater versatility to your dial, vernier or electronic calipers.



Sale \$59.00

List Price \$65.00

Features

- Robust housing
- Large LCD display
- Reading: 0.01"/0.1mm/1/64ths
- Accuracy: 0.01"/0.3mm/1/64ths
- Spring loaded with locking nut
- Plastic case

Order No.	Description	Range	List Price	Sale Price
54-554-630-0	Outside Caliper Gage	0 - 6"/0 - 105mm	\$66.00	\$60.00
54-554-730-0	Inside Caliper Gage	0.5" - 6"/12.7 - 150mm	\$66.00	\$60.00

Prices & Specifications are subject to change without notice.

35

Calipers

HIGH PRECISION
Fowler

XTRA-RANGE[®] Carbon Fiber Electronic Calipers

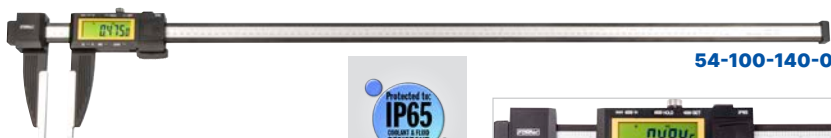

54-100-140-0



Features:

- IP65 protected against fluid and dust
- Lightweight carbon fiber frame
- Stainless steel jaws with ID ribs
- ID/OD pressure device for repeatability
- USB data output (works with 54-520-399-0)
- Preset, ABS/INC, Floating zero, IN/MM, Hold function
- Super large display
- Fitted wooden case



Features constant measuring force mechanism

Order No.	Range	Accuracy	Jaw Depth	Weight	List Price	Sale Price
54-100-124-0	0 - 24"/600mm	0.0020"/0.05mm	5.4"/138mm	2.85 lbs.	\$908.00	\$818.00
54-100-140-0	0 - 40"/1000mm	0.0025"/0.06mm	5.4"/138mm	3.45 lbs	\$1,645.00	\$1,316.00
54-100-160-0	0 - 60"/1500mm	0.0055"/0.13mm	5.9"/150mm	3.45 lbs	\$2,195.00	\$1,866.00

XTRA-RANGE[®] Electronic Calipers

For large measurements



Features:

- IP54 protected against fluid and dust
- Resolution: 0.0005"/0.01mm
- Hold feature
- Absolute/Incremental measurement
- Preset mode includes offset size for ID measurements
- Both sizes feature fine adjustment

54-100-312-0

Order No.	Range	Accuracy	Jaw Depth	List Price	Sale Price
54-100-312-0	0 - 12"/300mm	± 0.002"/0.05mm	3.5"	\$315.00	\$285.00
54-100-024-1	0 - 24"/600mm	± 0.003"/0.075mm	4"	\$515.00	\$465.00
54-100-042-1	0 - 40"/1000mm	± 0.004"/0.1mm	4.9"	\$1,271.00	\$1,144.00

XTRA-RANGE[®] Dial Calipers

With full length depth rod



Features:

- Graduations: 0.001"
- Jaw depth: 3.125"
- Stainless steel construction
- Satin chrome finish
- Full length depth rod
- 0.50" internal measuring nibs on jaws

52-008-024-0

Order No.	Range	Accuracy	List Price	Sale Price
52-008-018-0	0 - 18"	± 0.003"	\$268.00	\$242.00
52-008-024-0	0 - 24"	± 0.003"	\$383.00	\$345.00

Premium Grade Dial Calipers

With mono-block housing for added protection.

The mono-block housing design of this Premium Dial Caliper aids in preventing debris from entering the gearing mechanism. The covered rack aids in preventing debris from entering the rack. This helps to ensure years of continued service and accuracy.



Calipers

Features:

- Tough shockproof gearing with ultra smooth movement
- 4-way measuring, inside, outside, depth and step
- Solid stainless steel construction with lapped measuring faces
- Heavy duty frame, 1.41"/3.6mm thickness
- 0.100" range per revolution
- 0.001" reading dial, 0.100" range per revolution

Order No.	Range	Dial Color	Accuracy	List Price	Sale Price
52-008-704-1	0 - 4"	White	± 0.001"	\$105.00	\$79.00
52-008-714-1	0 - 4"	Black	± 0.001"	\$105.00	\$79.00
52-008-706-0	0 - 6"	White	± 0.001"	\$96.00	\$87.00
52-008-707-0	0 - 6"	Black	± 0.001"	\$95.00	\$86.00
52-008-708-0	0 - 8"	White	± 0.0015"	\$145.00	\$131.00
52-008-712-0	0 - 12"	White	± 0.002"	\$212.00	\$192.00
Metric					
52-008-709-0	0 - 150mm	Yellow	± 0.02mm	\$123.00	\$111.00

Outside Vernier Micrometers

0.0001" graduations for higher accuracy



52-240-003-1



52-215-003-1

Features:

- Graduation: 0.0001"
- Microfine graduations on satin chrome finish and carbide tipped measuring faces
- Diameter of measuring faces: 0.256"
- Flatness: 0.00003"
- Spindle thread hardened, ground and lapped for ultimate accuracy
- Includes a wrench and case
- Sizes over 1"/25mm include a standard

Order No.	Range	Accuracy	Thimble	List Price	Sale Price
52-240-001-1	0 - 1"	± 0.00016"	Friction	\$57.00	\$52.00
52-240-101-1	0 - 1"	± 0.00016"	Ratchet	\$54.00	\$49.00
52-240-002-1	1" - 2"	± 0.00016"	Friction	\$81.00	\$73.00
52-240-102-1	1" - 2"	± 0.00016"	Ratchet	\$69.00	\$63.00
52-240-003-1	2" - 3"	± 0.0002"	Ratchet	\$65.00	\$59.00
52-240-004-1	3" - 4"	± 0.0002"	Ratchet	\$71.00	\$64.00
52-240-005-1	4" - 5"	± 0.00024"	Ratchet	\$93.00	\$84.00
52-240-006-1	5" - 6"	± 0.00024"	Ratchet	\$98.00	\$89.00
52-240-007-1	6" - 7"	± 0.00028"	Ratchet	\$122.00	\$110.00
52-240-008-1	7" - 8"	± 0.00028"	Ratchet	\$164.00	\$148.00
52-240-009-1	8" - 9"	± 0.00032"	Ratchet	\$143.00	\$129.00
52-240-010-1	9" - 10"	± 0.00032"	Ratchet	\$162.00	\$146.00
52-240-011-1	10" - 11"	± 0.00036"	Ratchet	\$221.00	\$199.00
52-240-012-1	11" - 12"	± 0.00036"	Ratchet	\$225.00	\$203.00
Sets					
52-215-003-1	0 - 3" with standards and fitted case			\$184.00	\$166.00
52-215-004-1	0 - 4" with standards and fitted case			\$304.00	\$274.00
52-215-006-1	0 - 6" with standards and fitted case			\$426.00	\$384.00
52-215-012-1	0 - 12" with standards and fitted case			\$1,337.00	\$1,204.00
52-215-812-1	6 - 12" Outside Inch Micrometer Set			\$1,342.00	\$1,141.00

Outside Vernier Micrometers

0.001" readings



52-253-001-1



Features:

- Graduation: 0.001"
- Carbide tipped measuring faces
- Diameter of measuring faces: 0.256"
- Anvil & spindle hardened and precision ground with microlap finish on tips
- Sizes over 1"/25mm include a standard

Order No.	Range	Accuracy	Thimble	List Price	Sale Price
52-253-001-1	0 - 1"	± 0.001"	Friction	\$57.00	\$49.00
52-253-101-1	0 - 1"	± 0.001"	Ratchet	\$76.00	\$65.00
52-253-002-1	1" - 2"	± 0.001"	Friction	\$62.00	\$53.00
52-253-102-1	1" - 2"	± 0.001"	Ratchet	\$57.00	\$50.00
52-253-003-1	2" - 3"	± 0.001"	Ratchet	\$93.00	\$80.00
52-253-004-1	3" - 4"	± 0.001"	Ratchet	\$73.00	\$63.00
52-253-005-1	4" - 5"	± 0.001"	Ratchet	\$81.00	\$69.00
52-253-006-1	5" - 6"	± 0.001"	Ratchet	\$94.00	\$81.00

Digit Counter Micrometers

0.001" digit counter.



52-224-001-1

Features:

- Digital counter reads to 0.001"
- Graduations: 0.0001" (using vernier)
- Microfine graduations on satin chrome
- Carbide tipped measuring faces
- Sizes over 1"/25mm include a standard
- Includes case

Order No.	Range	Accuracy	List Price	Sale Price
52-224-001-1	0 - 1"	0.00016"	\$154.00	\$131.00
52-224-002-1	1" - 2"	0.00016"	\$199.00	\$170.00
52-224-003-1	2" - 3"	0.0002"	\$227.00	\$193.00
52-224-004-1	3" - 4"	0.0002"	\$219.00	\$187.00

Set

52-224-103-0	0 - 3" set (set finished in grey enamel)	\$459.00	\$391.00
52-224-104-0	0 - 4" set (set finished in grey enamel)	\$847.00	\$720.00
52-224-220-0	0 - 75mm set (set finished in grey enamel)	\$537.00	\$457.00

RAPID-MIC

Quick-Displacement Electronic Micrometers

Fastest micrometer on the market!



54-815-030-0

Features:

- IP67 protected against fluid and dust
- Non-rotating spindle with 0.39"/10mm travel per thimble rotation
- Adjustable measuring force, 5N/10N (54-815-030-0 and 54-815-130-0 only)
- Menu customizable with free software
- Larger sizes and specialty anvil micrometers also available (special order)



54-815-111-0

Calibration certificates available for all sizes.

Order No.	Range	Accuracy	List Price	Sale Price
54-815-030-0	0 - 1.18"/0 - 30mm	0.00012"/0.003mm	\$850.00	\$809.00

Set

54-815-111-0	0 - 4"/0 - 102mm		\$4,200.00	\$3,991.00
---------------------	------------------	--	------------	------------

Bluetooth Models

54-815-130-0	0 - 1.18"/0 - 30mm	0.00012"/0.003mm	\$1,200.00	\$1,141.00
---------------------	--------------------	------------------	------------	------------

Bluetooth Set

54-815-112-0	0 - 4"/0 - 102mm	0.00020"/0.005mm	\$5,300.00	\$5,036.00
---------------------	------------------	------------------	------------	------------

Connectivity Cables/Accessories

54-981-724-5	Sylcom Pro (digital license)		\$2,585.00	\$2,457.00
54-981-713-2	Sylcom Standard (dongle license)		\$1,102.00	\$1,047.00
54-115-526-0	Proximity cable with USB Connection		\$251.00	\$226.00
54-115-527-0	Proximity cable with Serial Connection		\$294.00	\$266.00
54-115-246-BT	USB Bluetooth Receiver		\$58.00	\$53.00

Electronic Coolant Resistant Micrometers

For basic outside measurements with higher protection.



54-860-001-0

Features:

- Protected to IP54 specifications
- Large LCD Display
- Accuracy: .00016"
- Automatic switch off
- Resolution: .00005"/.001mm
- Direct RS-232 output
- Carbide measuring faces
- Absolute & incremental modes
- Sizes over 1"/25mm include standard



Order No.	Range	Accuracy	List Price	Sale Price
54-860-001-1	0 - 1"/0 - 25mm	± 0.00016"/0.004mm	\$197.00	\$178.00
54-860-002-1	1 - 2"/25 - 50mm w/standard	± 0.00016"/0.004mm	\$211.00	\$190.00
54-860-003-1	2 - 3"/50 - 75mm w/standard	± 0.0002"/0.005mm	\$221.00	\$199.00
Set				
54-860-103-1	0 - 3"/0 - 75mm w/standards		\$599.00	\$540.00

XTRA-VALUE II Electronic Micrometers



54-870-001-0

Features:

- IP40 protected against fluid and dust
- Resolution: 0.00005"/0.001mm
- Carbide measuring faces
- Absolute and incremental modes
- Ratchet thimble
- Free ball attachment included
- Sizes over 1"/25mm include a calibration standard



Order No.	Range	Accuracy	List Price	Sale Price
54-870-001-0	0 - 1"/0 - 25mm	± 0.00016"/0.004mm	\$106.00	\$96.00
54-870-002-0	1" - 2"/25 - 50mm	± 0.00016"/0.004mm	\$141.00	\$128.00
54-870-003-0	2" - 3"/50 - 75mm	± 0.0002"/0.005mm	\$172.00	\$155.00

Prices & Specifications are subject to change without notice.

Electronic IP54 Blade Micrometers



54-860-275-0

Sale \$277.00

List Price \$307.00

Features:

- IP54 protected against fluid and dust
- Each gage includes appropriate setting ring for exceptional accuracy
- Resolution: 0.00005"/0.001mm
- Friction thimble
- Includes fitted case



Vernier Inch Blade Micrometers



52-246-001-1

Sale \$255.00

List Price \$283.00

Features:

- Anvil & spindle hardened & precision ground with microlap finish on ends
- Non-rotating spindle
- Ratchet thimble
- Blade thickness = 0.030"; blade width = 0.256"; blade penetration = 0.315"
- Sizes over 1" include a standard

Order No.	Range	Graduation	Accuracy	List Price	Sale Price
52-246-001-1	0 - 1"	0.0001"	0.0001"	\$304.00	\$274.00
52-246-002-1	1" - 2"	0.0001"	0.00016"	\$318.00	\$288.00

Electronic IP54 Disc Micrometers

For accurate pitch diameter measurements.



54-860-301-0

Features:

- Water Resistant to IP54 specifications
- True inch/metric conversion
- Friction thimble
- Large easy-to-read LCD display
- Extra large .788" disc with .035" edge thickness
- Easily enters hard-to-reach areas
- Includes case



Order No.	Range	Resolution	Accuracy	List Price	Sale Price
54-860-301-0	0-1"/0-25mm	0.00005"/.001mm	± 0.00016"	\$338.00	\$305.00

Vernier Thread Micrometers



52-219-001-1

Sale \$139.00

List Price \$154.00

Features:

- 60° measuring anvils
- Graduation: 0.001"
- Ratchet thimble
- Sizes over 1" include standard

Order No.	Range	Thread Range	Accuracy	List Price	Sale Price
52-219-001-1	0 - 1"	64 - 5 TPI / 0.4 - 5mm	0.00016"	\$154.00	\$139.00

Prices & Specifications are subject to change without notice.

43

Micrometers

Fowler
HIGH PRECISION

26.1

IP54 Electronic Depth Micrometer



Sale \$259.00

List Price \$287.00

Features:

- IP54 protected against fluid and dust
- Range: 0 - 6"/150mm
- Accuracy: 0.00016"/0.004mm
- Resolution: 0.00005"/0.001mm
- Base surface hardened and microlapped to 0.00008" flatness
- Rod diameter: 0.176"



Order No. 54-225-456-0

Depth Micrometers

Features:

- Satin chrome finish
- Base surface hardened and microlapped to 0.00008"
- Ratchet thimble
- Locking clamp
- Rod diameter: 0.176"
- Includes fitted case



Sale \$215.00

List Price \$238.00

Order No. 52-225-110-0

Order No.	Range	Graduation	Accuracy	Base Size	List price	Sale Price
52-225-110-0	0 - 4"	0.001"	0.0002"	2.5"	\$238.00	\$215.00
52-225-112-0	0 - 6"	0.001"	0.0002"	2.5"	\$256.00	\$231.00
52-225-114-0	0 - 4"	0.001"	0.0002"	4"	\$213.00	\$193.00
52-225-116-0	0 - 6"	0.001"	0.0002"	4"	\$256.00	\$232.00

Interchangeable Anvil Bluetooth Depth Gage

Features:

- Supplied standard with mono-plane measuring probe
- Measure normal or inverted positions using the same probe
- Optional measuring inserts available
- Coolant proof, dust proof - IP67
- Bluetooth communication for error free data collection
- 4" measuring base. 8" & 12.5" base attachments available
- Available in 3 ranges. 8", 12" & 19"
- Frame made of hardened stainless steel
- Sleep mode after 20 minutes and automatic wake-up with movement



Sale \$1,569.⁰⁰

List Price \$1,650.00

Order No. 54-139-160-1

X-DEPTH 22⁺ 0 - 22" Electronic Depth Gage

Provides rapid electronic measurement of hole depths.

Features:

- 0-1" AGD Group 2
- Accuracy: 0.001"/0.03mm
- Resolution: 0.0005"/0.01mm
- 4" base ground and lapped for flatness
- Rods connect for 22" capacity
- Includes 2 extra points (spline & needle)
- Tolerance function



Sale \$218.⁰⁰

List Price \$241.00

Order No. 54-125-777-0

X-DEPTH 22[®] 0 - 22" Dial Depth Gage

Features:

- 0 - 1" travel indicator with 4" base
- 0.001" Graduations
- Rods connect together for full 22" capacity
- Satin chrome finish
- Includes 2 extra points for small hole applications; one 0.078" dia. x 1" long and one needle point x 1" long

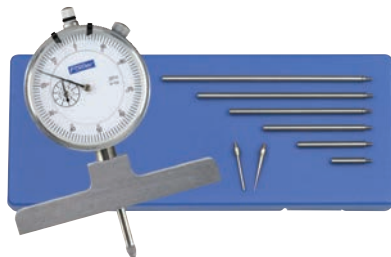

Sale \$132.⁰⁰

List Price \$146.00

Order No. 52-125-006-1

Mark VI Sylvac Electronic Indicators

Features:

- IP54 protected against fluid and dust
- Output: Proximity/Power - USB/RS232/digimatic/Wireless
- Functions (MIN/MAX/DELTA, TOL, Factor, Preset, Auto Off)
- Large display with LED tolerance indicators

Order No. 54-530-335-0



Calibration certificates available for all sizes

Order No.	Range	Accuracy	Resolution	List Price	Sale Price
Low Resolution					
54-530-125-0	0 - 0.500"/12.5mm	0.0004"/0.01mm	0.0005"/0.01mm	\$769.00	\$731.00
54-530-145-0	0 - 1"/25mm	0.0004"/0.01mm	0.0005"/0.01mm	\$950.00	\$904.00
High Resolution					
54-530-135-0	0 - 0.500"/12.5mm	0.00012"/0.003mm	0.00005"/0.001mm	\$1,050.00	\$999.00
54-530-155-0	0 - 1"/25mm	0.00016"/0.004mm	0.00005"/0.001mm	\$1,150.00	\$1,093.00
54-530-175-0	0 - 2"/50mm	0.00019"/0.005mm	0.00005"/0.001mm	\$1,950.00	\$1,853.00
Bluetooth					
54-530-335-0	0 - 0.500"/12.5mm	0.00012"/0.003mm	0.00005"/0.001mm	\$1,202.00	\$1,142.00
54-530-355-0	0 - 1"/25mm	0.00016"/0.004mm	0.00005"/0.001mm	\$1,162.00	\$1,104.00
Accessories					
54-981-724-5	Sylcom Pro (digital license)			\$2,585.00	\$2,457.00
54-981-713-2	Sylcom Standard (dongle license)			\$1,102.00	\$1,047.00
54-115-246-BT	USB Bluetooth Receiver			\$58.00	\$53.00

INDI-X^{blue}

Electronic Indicators

Our most popular electronic indicators.

Features:

- Resolution 0.0005"/0.01mm
- 54-520-260-0 also reads 1/64ths
- 2-1/4" dial face
- Lugback and 3/8" stem mountings
- Tolerance function
- Absolute/incremental reading
- Floating zero



54-520-255-0



54-520-250-0



54-520-260-0



Calibration certificates available for all sizes

Order No.	Range	Accuracy	List Price	Sale Price
54-520-255-0	0.50"/12.5mm	± 0.001"/0.03mm	\$91.00	\$82.00
54-520-250-0	1"/25mm	± 0.001"/0.03mm	\$88.00	\$80.00
54-520-260-0	1"/25mm	± 0.001"/0.03mm	\$109.00	\$99.00

Premium Dial Indicators

Smooth, accurate and built tough.

Features:

- AGD Group 2 specifications
- Accuracy meets ANSI standards
- Shockproof gearing
- Jeweled movement
- Tolerance markers
- Solid steel housing
- Carbide contact point
- Includes NIST Certification



52-520-135-0

52-520-105-0

52-520-110-1

Order No.	Range	Graduation	Reading	Balanced Reading	Dial Color	List Price	Sale Price
52-520-105-0	0.50"	0.001"	0 - 100	0 - 50 - 0	White	\$123.00	\$99.00
52-520-110-1	1"	0.001"	0 - 100	—	Black	\$70.00	\$56.00
52-520-110-2	1"	0.001"	0 - 100	—	White	\$70.00	\$56.00
52-520-120-0	2"	0.001"	0 - 100	—	White	\$186.00	\$149.00
52-520-129-0	1"	0.0005"	0 - 50	0 - 25 - 0	White	\$43.00	\$35.00
52-520-300-0	10mm	0.01mm	0 - 100	0 - 50 - 0	White	\$148.00	\$119.00
52-520-500-0	25mm	0.01mm	0 - 100	0 - 50 - 0	White	\$178.00	\$142.00

Magnetic Indicators

Features:

Mag Back:

- Attaches to most 4 hole indicator backs

AGD Group 2 Indicator Features:

- 1" travel
- AGD group 2
- 2-1/4" dial diameter
- Reading: 0.001"
- Continuous reading: 0-100
- Revolution counter
- Tolerance indicators

Sale \$59.00

List Price \$65.00



Order No. 52-520-485-0

Order No.	Description	List Price	Sale Price
52-520-485-0	Magnetic Back with AGD Group 2 Indicator	\$65.00	\$59.00
52-585-495-0	Magnetic Back (for 4 hole backs with 1.8" centerline distance only)	\$29.00	\$24.00

Depth Base Attachments

Features:

- Turn your dial or electronic indicator into a depth gage
- 4" length
- Fits indicators with 3/8" and 8mm mounting stems
- Ground and lapped base
- Each supplied with 4 extension points, for added application range (4 - 48 thread)



Order No. 52-125-004-0

Order No.	Description	List Price	Sale Price
52-125-004-0	Flat depth base attachment	\$52.00	\$47.00

QuadraTest

Electronic Test Indicators

Features:

- Bluetooth connectivity to your phone or tablet
- IP65 protected against fluid and dust
- 4 measuring modes: Min, Max, TIR and Direct
- 4 measuring resolutions - 0.00005"/0.001mm or 0.0005"/0.01mm
- 1-1/2" diameter dial face rotates a full 360°
- Analog scale for reversal point indication
- Meets or exceeds DIN/ISO Standards (Maximum error on 0.00005" scale at full range: 0.0004")
- 54-562-890-BT is capable of interchanging contact point lengths



54-562-777-BT



Calibration certificates available for all sizes.

Order No.	Range	Contact Point Length	List Price	Sale Price
54-562-777-BT	0.030"/0.80mm	1/2"	\$910.00	\$865.00
54-562-888-BT	0.080"/2.0mm	1-7/16"	\$1,050.00	\$998.00
54-562-890-BT	0.030"/0.80mm 0.080"/2.0mm	1/2" 1-7/16"	\$1,150.00	\$1,094.00

X-TEST®

Horizontal & Vertical Test Indicators

Features:

- Super smooth jeweled movement
- Smooth bezel adjustment for easy zero setting
- Accuracy meets DIN 2270 standards
- 0.080" and 0.120" carbide ball contact points (0.040" steel ball)
- 0.060" range with auto reverse and rev. counter
- Easy to read tilted dial
- 5/32" pivotable stem



52-562-005-0



52-562-003-0



52-562-002-BD

Order No.	Graduation	Dial Size	Dial Reading	List Price	Sale Price
Horizontal					
52-562-001-0	0.0005"	1-1/2"	0 - 15 - 0	\$170.00	\$154.00
52-562-002-BD	0.0005"	1-1/2"	0 - 15 - 0	\$185.00	\$167.00
52-562-003-0	0.001"	1"	0 - 15 - 0	\$175.00	\$158.00
Vertical					
52-562-004-0	0.0005"	1-1/2"	0 - 15 - 0	\$182.00	\$164.00

Indi-X Blue Electronic Indicator and Stand Combo



Sale \$180.00
List Price \$199.00

Features:

- Direct Inch/Metric/Fraction conversion
- Auto off feature
- Lugback and 3/8" stem mountings
- Resolution: .0005"/.01mm/64ths
- Tolerance indicators
- Absolute/incremental reading
- Floating zero
- Carbide tipped point

Stand:

- 6" x 6" x 2" granite base
- Positive lock screw
- Fine adjustment knob for zero setting
- Column height is 8"

Order No. 54-580-250-0



Fine Adjust Mag Base With Black Dial Indicator Set

Indicator Features:

- Range: 0-1"
- Graduation: 0.001"
- Meets AGD specifications
- Continuous reading 0-100
- Revolution counter
- Tolerance indicators

Magnetic Base Features:

- Fine adjustment
- Base dimensions: 2" x 2-11/32" x 1-13/16"
- Also mounts test indicators with 1/4" post
- 85 lb. pull
- On-Off lever release magnet
- V-base for placing on round surfaces

Sale \$85.00

List Price \$94.00

Order No. 52-520-199-0

Fine Adjust Mag Base Set with Mag Back

With **INDI-X blue** Electronic Indicator or AGD White face Indicator

AGD Indicator features:

- AGD Group 2
- Dial diameter: 2-1/4"
- Travel: 1"
- Reading: 0.001"
- Continuous reading: 0 - 100
- Carbide tipped point



Indi-X blue features:

- Resolution 0.0005"/0.01mm
- 2-1/4" dial face
- Lugback and 3/8" stem mountings
- Tolerance function
- Absolute/incremental reading
- Floating zero

Magnetic Base features:

- 85 lb. pull
- Fine adjustment
- V-bottom base

Magnetic Indicator Back features:

- Use for positioning the indicator on most metal surfaces
- Protective coating

Order No.	Description	List Price	Sale Price
54-585-075-0	Fine Adjust Mag Base Set w/Indi-X blue Indicator Set	\$161.00	\$145.00
52-585-125-0	Fine Adjust Mag Base Set w/AGD Dial Indicator Set	\$199.00	\$170.00

Prices & Specifications are subject to change without notice.



Granite Dial Gage Stand

Sturdy with 0.00005" flatness

Features:

- 6" x 6" x 2" granite base
- Positive lock screw
- Fine adjustment knob for zero setting
- Column height is 8"
- Accepts all lug-back indicators

Order No. 52-580-030-0

Sale \$135.00

List Price \$149.00

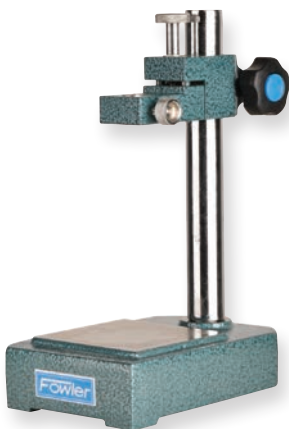

Deluxe Dial Gage Stand

Holds indicators and probes for thickness and comparative measurements.

Features:

- Quick positioning and adjustment
- Zero settings with fine adjustment
- Fine adjustment of 5/32"
- Holds indicators with stems of 3/8" and 8mm
- Working surface of 3-1/2" x 3-1/2"

Order No. 52-580-015-0

Sale \$433.00

List Price \$481.00



Height Transfer & Squareness Gage

Small and compact

Features:

- Used for a variety of surface plate applications
- Large fine adjustment knob for precise control
- Swivel clamp anchors swivel and indicator for added accuracy
- Rear surface of the gage has a reference surface to place against a master for checking squareness
- Includes a 7.5" post, indicator rod

Order No. 53-620-010-0

Sale \$381.00

List Price \$423.00

Indicator and standard shown not included

Articulating Magnetic Base

Features:

- Adjusts in almost unlimited ways
- Fine adjust
- 85 lb. pull
- V-slot on base for mounting on rounded surfaces

Order No. 52-585-008-0

Sale \$131.00

List Price \$145.00



Magnetic Bases

Features:

- 9.5" Height and 85 lb. pull
- Base dimensions are 2" x 2-11/32" x 1-13/16" (50mm x 58.7mm x 46mm)
- Accepts all AGD dial indicators
- V-bottom base allows mounting on cylindrical surfaces
- Mounts test indicators with 1/4" post mount

52-585-005-0



52-585-010-0



Order No.	Description	List Price	Sale Price
52-585-005-0	Magnetic Base	\$77.00	\$62.00
52-585-010-0	Magnetic Base with fine adjustment	\$83.00	\$67.00

Flex Arm Magnetic Bases

Adjustable to any position.

Features:

- All purpose magnetic base with 100 lbs. of pulling power
- Base can be mounted vertically as well as horizontally
- V-bottom base allows mounting on cylindrical surfaces
- Accepts AGD indicators as well as Test Indicators with a stem

Chrome Flex Arm Features:

- Corrosion resistant chrome plated flex arm
- 100 lb pull magnetic base

52-585-015-0

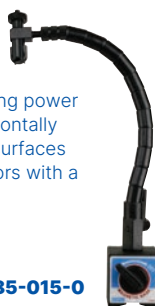

52-585-045-0



Order No.	Description	List Price	Sale Price
52-585-015-0	Flex Arm Magnetic Base	\$85.00	\$77.00
52-585-045-0	Chrome Flex Arm Magnetic Base	\$134.00	\$121.00

Clinotronic-S

The Clinotronic-S is a portable precision instrument for measuring inclinations up to $\pm 45^\circ$. The large, backlit, high contrast color display provides excellent readability even under adverse conditions in the workshop or under a machine.

The Clinotronic-S can be connected to an Android™ device, which can then be used as a remote display. This new feature makes the instrument much more versatile and suitable for many applications. It is built on the success of the Clinotronic PLUS, while retaining the features that made it famous, like its reliability and versatility, plus it adds the latest technology:



Features:

- Wireless functionality (APP wylerUNIVERSAL for Android™), USB cable as well
- Accuracy: ± 3 arc minutes at 45°
- User friendly
- Adjustable to local gravity
- Improved mechanical accuracy
- Excellent color display with low power consumption

Order No. 54-635-605-0

Sale \$4,795.00

List \$5,327.00

Clinotronic Plus

Clinotronic Plus is an electronic level with unsurpassed versatility. It is economically priced, uses a specially designed microprocessor and the well-proven Wyler inclination sensor.



Features:

- Range of $\pm 45^\circ$, capacity of 0-360°
- Accuracy: ± 3 arc minutes at 45°
- Resolution of 0.01° (selectable)
- Absolute or relative measuring mode selectable by push button
- Seal-tec technology for excellent performance even in difficult environmental conditions
- Interface connection RS-232 is integrated. Special purpose cables available
- No loss of calibration data by power failure
- Response time: value available within 5 seconds
- Repeatability: $< 0.01^\circ$
- Linearity: 3 min. of arc + 1
- Housing: aluminum hard anodized.
- Dimensions: 4 x 3 x 1"(100 x 75 x 30mm)

Sale \$4,275.00

Order No. 54-635-601-0

List \$4,500.00

Digi Level **PLUS+**

with smart wireless data



Features:

- IP65 protected against fluid and dust
- Includes a 6" straight edge with beveled edge and 1/32nds graduations
- V's on top and bottom for measuring on cylindrical surfaces
- Embedded magnets on bottom base for vertical and horizontal hold
- Accuracy: $\pm 0.2^\circ$
- Resolution: 0.050°

Sale \$177.00

List Price \$196.00

Order No.	Description	List Price	Sale Price
54-422-550-BT	Digi-Level PLUS with smart wireless	\$196.00	\$177.00

mini-MAG Protractor

The mini-MAG Protractor provides instant 360° digital inclination display of any angle.

Features:

- Accuracy: $\pm 0.2^\circ$
- Resolution: 0.05°
- Embedded magnets
- Display automatically inverts
- Dimensions: 2.375" x 1.375" x 2.375"
- Hold feature
- Battery Life: up to 250 hrs.



Display inverts for easy reading!



Order No. 54-422-450-1

Sale \$102.00

List Price \$113.00

mini-MAG PLUS Protractor

The Mini-Mag PLUS Protractor features a USB rechargeable battery, a backlit display, Tilt% function and IP54 protection against water, oil, and fluids.

Features:

- IP54 protected against fluid and dust
- Auto off after 5 minutes
- Embedded magnets
- Display automatically inverts
- Smaller size: 2.12" x 2.12" x 0.9"
- Measuring range: 360° (4 x 90)
- Accuracy: $\pm 0.2^\circ$
- Resolution: 0.05°
- Hold feature
- Zero function



Sale \$108.00

List Price \$120.00

Order No. 54-422-500-0

Shop Tools

Fowler
HIGH PRECISION



54-440-775-1



54-440-740-1

Digi-Level PRO Electronic Protractors

Includes embedded magnets for unique measurement areas. On/Off, Zero, Hold and Reverse features.

Features:

- Ideal for fabrication applications
- Embedded 25 lb. pull magnets
- Full, 360° measuring range
- Accuracy: $\pm 0.2^\circ$
- Repeatability: $\pm 0.05^\circ$
- Resolution: 0.1°
- Includes standard 3V lithium battery

Order No.	Description	List Price	Sale Price
54-440-740-1	4" Digi-Level PRO	\$105.00	\$95.00
54-440-775-1	12" Digi-Level PRO	\$141.00	\$127.00



Square, Protractor and Center Head With 12" Blade

Features:

- Blades are chrome plated, fully hardened and tempered
- Square head has level and scriber point
- Double indexed protractor is graduated 180° in both directions
- Graduated in 8ths, 16ths, 32nds and 64ths

Order No. 52-370-012-0

Sale \$152.00

List Price \$202.00

X-BLOX® V-Block Set

2 each @:

- Dimensions: 1-1/2" L x 1-1/4" W x 1-1/4" H
- Work capacity: Approximately 1"

2 each @:

- Dimensions: 2" L x 1-1/2" W x 1-1/2" H
- Work capacity: 1-1/2"

All feature:

- Surfaces are square and parallel within 0.0005"
- V-grooves are square and parallel with all surfaces within 0.0005"
- Corresponding dimensions for each pair are alike within 0.0005"

Order No. 52-475-500-0



Sale \$250.00
List Price \$276.00

26.1



1-2-3 & 2-4-6 Blocks

Useful in layout, inspection and grinding work.

Features:

- 23 holes for easy clamping
- Sold in pairs
- Hardened 56 - 60 HRC
- Both styles include 5 threaded holes, 3/8" - 16

Order No.	Description	Accuracy	List Price	Sale Price
52-439-031-0	1-2-3 Blocks	± 0.0001"/1"	\$60.00	\$54.00
52-439-032-0	1-2-3 Blocks	± 0.0002"/1"	\$113.00	\$102.00
52-439-246-0	2-4-6 Blocks	± 0.0003"/1"	\$230.00	\$208.00

1/8" Parallel Set

Features:

- 2 each of 1/2", 5/8", 3/4", 7/8", 1", 1-1/8", 1-1/4", 1-3/8", 1-1/2" & 1-5/8" heights
- Absolute heights are nominal
- Hardness: 50 HRC, 6" length
- 52-437-000-0 paired in height: 0.001"

Order No. 52-437-000-0



Sale \$242.00
List Price \$268.00

Prices & Specifications are subject to change without notice.

Shop Tools

Fowler
HIGH PRECISION



Bevel Edge Squares

Features:

- Designed for layout & measurement work
- Squares have accurate right angles both inside and outside
- Made from a single piece of fully seasoned tool steel
- Beams and blades are ground and lapped for straightness and parallelism
- Blades beveled both edges
- Fully hardened to Rockwell 55C
- Packed in individual carton
- Accuracy = $\frac{0.00008"}{100,000}$ + Length (blade)

Order No.	Blade Length	Beam Length	List Price	Sale Price
52-426-005-0	4-7/8"	3-1/8"	\$101.00	\$91.00
52-426-008-0	7-7/8"	5-1/8"	\$132.00	\$119.00

Cylindrical Squares

Features:

- Used for checking squares, height gages and other instruments
- Hardened and the ends are lapped to 90° angular accuracy
- 6" cylindrical squares: ± 0.0001"
- 12" cylindrical squares: ± 0.00015"



Order No.	Description	List Price	Sale Price
52-750-006-0	6" Height/3" Ø	\$385.00	\$348.00
52-750-012-0	12" Height/4" Ø	\$553.00	\$498.00

Gage Ball Sets

Features:

- Ball gages are ground and lapped chrome steel
- Hardened to 63RC
- Grade 24 accuracy - AFBMA certificate
- Within .0001" of actual size
- Sphericity within .000025"
- Surface finish to 1.5 micro inches
- 52-438-766 Set includes 26 pairs
- Pair sizes in inches: 1/8, 9/64, 5/32, 3/16, 7/32, 1/4, 9/32, 5/16, 11/32, 3/8, 13/32, 7/16, 15/32, 1/2, 17/32, 9/16, 19/32, 5/8, 21/32, 11/16, 23/32, 3/4, 13/16, 7/8, 15/16 and 1"
- 52-438-777-0 Set includes 25 pairs
- Pair sizes in mm: 1mm through 25mm



52-438-766-0

Sale \$103.00

List Price \$113.00

Order No.	Description	List Price	Sale Price
52-438-766-0	52 piece Gage Ball Set	\$113.00	\$103.00
52-438-777-0	50 piece Metric Gage Ball Set	\$120.00	\$108.00

SHOP-BLOX® Rectangular Gage Block Sets



Features:

- Manufactured to meet Federal Specification ASME B89. 1.9 - 2002 tolerances on length for inch gage blocks
- Certificate of Calibration traceable to NIST
- Tolerances to ± 0.00005 "
- In high-quality fitted case

Order No.	Description	List Price	Sale Price
53-672-036-0	36 pieces	\$205.00	\$175.00
53-672-081-0	81 pieces	\$295.00	\$250.00

Quill Adapter Kit PLUS



Features:

- Includes quill installation tool kit
- 0 - 6"/150mm travel
- Accuracy: ± 0.001 "/0.03mm
- Resolution: 0.0005"/0.01mm/1/64"
- Preset, zero, in/mm, absolute/incremental, on/off functions
- Stainless steel construction
- Interchangeable mounting brackets with hardware
- IP54 protected against fluid and dust
- Large display 9.5mm
- Uses 1 CR2032, 3V battery (2 included)

Sale \$189.00

List Price \$209.00

Order No. 54-050-100-0

COAX-2D 2 Dimensional Coaxial Indicator Sets

Use the 2D Coaxial Set for accurate component centering and positioning in most machining applications. The dial remains stationary during the rotation of the machine spindle.

Features:

- Graduations and revolution counter 0.0005"/0.01mm)
- 3 internal and 3 external feelers; ball dia.: 1/8" (3mm)
- Includes center point feeler and staining arm
- Restraining arm
- Shank: 3/8" dia. x 7/8" long (10mm x 20mm)
- Measuring range: 0.250" (6mm) axis offset
- Speed recommended 800 RPM max.
- Repeatability to within 0.0002" (0.005mm) of true center
- Capacity, depending on feeler is 5/32-12"/4-300mm) internal diameter; 0-12"/0-300mm external diameter



Order No.	Description	List Price	Sale Price
52-710-025-0	2D Coaxial Set - Inch	\$353.00	\$329.00
52-710-030-0	2D Coaxial Set - Metric	\$353.00	\$329.00

52-710-025-0



Z-CHECK 65 PLUS+

Z-Axis Tool Setter

Features:

- Supplied with zero reference setting block
- IP65 protected against fluid and dust
- Back light turns on when zero reference is achieved
- 4 magnets embedded into base
- 2" default setting height
- Steel contact surface with 0.0002" flatness
- Resolution: 0.00005"/0.001mm
- Repeatability: 0.00015"/0.004mm
- Accuracy: 0.0001"/0.003mm



Sale \$164.00

List Price \$182.00

Order No. 54-188-200-0



Electronic Edge Finders



Features:

- Six equally spaced light ports provide visibility at any angle
- Edge finder lights instantly when stylus touches work edge
- Repeatability: 0.0002"
- Works on any conductive metal



Along with light indication, model #54-575-650-0 emits an audible "beep" at time of contact

Order No.	Stylus	Shank	Audible	List Price	Sale Price
54-575-600-0	0.200"	1/2"	NO	\$77.00	\$70.00
54-575-625-0	0.200"	1/2"	NO	\$264.00	\$255.00
54-575-650-0	0.400"	3/4"	YES	\$264.00	\$255.00

HIGH Accuracy Z-Axis Detectors

For use in CNC machines and other applications where high accuracy is required.



Sale \$387.00

List Price \$429.00



Features:

- IP67 protected against fluid and dust
- High accuracy and repeatability, $\pm 0.000039"/0.001\text{mm}$
- Carbide touch surface (0.196"/5mm)
- High precision bearing guide system for long life
- Interchangeable magnetic base
- High visibility LED indicator
- Movement stroke 0.078"/2mm
- Battery life approximately 250 hours (on time)

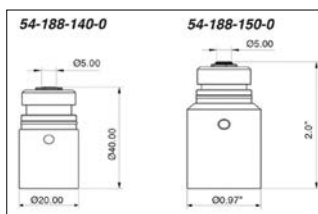

Order No.	Model	Description	List Price	Sale Price
54-188-150-0	Inch	Height: 2"/50.8mm, Dia. 0.97"/24.638mm	\$312.00	\$281.00
54-188-140-0	Metric	Height: 1.57"/40mm, Dia. 0.78"/20mm	\$429.00	\$387.00

Bore Gage Setting Master Kits

Fowler's Bore Gage Setting Master Kit is used for accurately setting any bore gage up to 6"/150mm in diameter to an accuracy of 0.0001"/0.003mm.



Each Set includes:

Setting Device

- Base anvil: 3.950" x 1.050"
- Adjustable anvil: 2.375" x 0.375" (two of each)
- Internal capacity: 6"/150mm
- Centralizer capacity width: 2.750"
- Quick-release holder for fast adjustment

Economy Gage Block Sets

Inch model:

- 36 piece
- Tolerances to 0.00005"
- Certificate of Calibration to NIST

Metric model available.

Check out the X-Tender-E Plus Bore Gage Set and Dial Cylinder Bore Gages on pgs. 30-31

Bore gage shown not included

Order No.	Description	List Price	Sale Price
53-646-000-1	Inch Bore Gage Setting Master Kit	\$501.00	\$451.00
53-646-005-0	Bore Gage Setting Master Kit - without Gage Blocks	\$320.00	\$289.00

Optical Comparator with Accessory Package



**Includes:
T-Slot V-Blocks
& T-Slot Centers
shown**

The Fowler comparator is economically designed for basic comparative and absolute measurements and includes:

- 10x Lens
- 12" 1 Quadrant protractor screen
- T-slot stage with 6" horizontal travel and 2.5" vertical travel
- 1 pair of t-slot mounted V-blocks
- 1 pair of t-slot mounted centers
- 2 Indi-X Indicators (page 30):
1"/25mm capacity with 0.0005"/0.01mm resolution

Order No.	Description	List Price	Sale Price
53-900-000-0	12" Basic Bench Top Optical Comparator without Accessories	\$4,014.00	\$3,412.00
53-900-100-0	Optical Comparator with Accessory Package	\$4,292.00	\$3,649.00
Accessories			
53-900-020-0	20x Lens	\$358.00	\$287.00

10x Pocket Optical Comparator with 9 reticles

Fowler's 10x Pocket Optical Comparator magnifies images which are sharp, undistorted and free of aberrations. Convenient for checking angles, thread measurements, hole sizes and more. This 10x comparator is widely used by machinists, toolmakers and inspectors in the industry.



Features:

- Scales are photo-etched into a glass reticle which is placed in actual contact with the measured object, obtaining simultaneous enlarged images of the scale.
- Reticles (protected in individual plastic cases) are easily interchanged by a screw-in mount.
- Measures radii, diameters, angles, hole sizes, pitch and thicknesses.

Sale \$153.00

List Price \$179.00

Order No. 52-664-009-0

The X-Pro Portable Roughness Tester II can be used for various applications by selecting from a variety of accessories including special application probes and a swivel stand.

RS232 data output is available on additional models (contact the Fowler technical department for more information 1-800-788-2353)



(X-Pro shown with optional stand with swivel)



Features:

- Small, compact size
- 2 selectable parameters: Ra and Rz
- Large LCD display
- Meets ISO and DIN standards
- NIST traceable specimen included
- Uses 9 volt battery (approx. 3000 measurements)
- Special application probes available

X-Pro Portable Roughness Tester II

Order No.	Description	List Price	Sale Price
54-410-500-0	Portable Surface Roughness Tester 0.0004" probe (NIST specifications)	\$2,808.00	\$2,528.00
54-410-600-0	Portable Surface Roughness Tester 0.0002" probe (DIN specifications)	\$2,808.00	\$2,528.00
54-400-896-0	Adjustable height stand for roughness testers	\$740.00	\$666.00

Tool Set 300 Presetter

Used for the quick checking of heights and diameters (radii) of various types of machine tools. Accuracy is guaranteed by a precise steel measuring column and displacement devices in X and Z coordinates utilizing constant measuring force.

Tool Holding Spindle

- Tool presetter is supplied with high precision tool pot (Grade 0)
- ISO 40 or 50 taper
 - Less than 0.00008"/0.002mm concentricity error

Features:

- Measuring range: (X)11.8"/300mm, (Z)15.7"/400mm
- Min/Max functions for TIR readings
- 2 reference indications
- Preset and Tolerance value inputs
- Radius or diameter indication on X-axis display
- Resolution: 0.00005"/0.001mm
- Floating zero function anywhere within axis range
- Carbide measuring insert for durability
- Counter balanced measuring carriage
- Constant measuring force in both axes
- High precision Swiss measuring system



54-188-300-0



Order No.	Description	List Price	Sale Price
54-188-300-0	Tool Presetter with 50 Taper Tool Pot	\$21,511.00	\$19,362.00
54-188-304-0	Tool Presetter with 40 Taper Tool Pot	\$12,507.00	\$11,257.00

Steel Rules

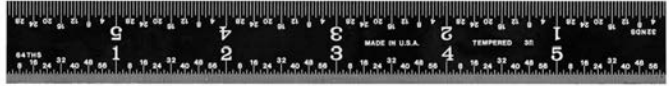

- Tempered steel
- Etched, non-glare, black finish
- 5R graduations: 32nds & 64ths, 10ths & 100ths
- 4R graduations: 8ths, 16ths, 32nds, & 64ths
- 16R graduations: 32nds, 64ths, 50ths, & 100ths
- Flexible rules: 0.020" thick
- Gold rules are titanium coated

Order No.	Graduation	Flexibility	Finish	Size	List Price	Sale Price
52-295-006-0	4R	Flexible	Satin Chrome	6"	\$16.00	\$14.00
52-297-006-0	4R	Flexible	Black	6"	\$18.00	\$13.00
52-295-012-0	4R	Flexible	Satin Chrome	12"	\$32.00	\$27.00
52-297-012-0	4R	Flexible	Black	12"	\$31.00	\$22.00
52-300-006-0	5R	Flexible	Satin Chrome	6"	\$20.00	\$14.00
52-307-006-0	5R	Flexible	Black	6"	\$18.00	\$13.00
52-307-012-0	5R	Flexible	Black	12"	\$30.00	\$21.00
52-308-006-0	16R	Flexible	Black	6"	\$15.00	\$13.00
52-310-006-0	16R	Flexible	Satin Chrome	6"	\$20.00	\$14.00
52-310-012-0	16R	Flexible	Satin Chrome	12"	\$30.00	\$27.00
52-330-006-0	4R	Rigid	Satin Chrome	6"	\$23.00	\$17.00
52-337-006-0	4R	Rigid	Black	6"	\$20.00	\$14.00
52-330-012-0	4R	Rigid	Satin Chrome	12"	\$32.00	\$29.00
52-350-006-0	16R	Rigid	Satin Chrome	6"	\$17.00	\$15.00
52-338-006-0	16R	Rigid	Black	6"	\$17.00	\$14.00
52-350-012-0	16R	Rigid	Satin Chrome	12"	\$36.00	\$29.00

Pocket Steel Rule



- Rounded edge prevents damage to shirt pocket
- Rule width: 0.470"
- Inch graduations are in 64ths
- Rule thickness: 0.021"
- Metric scale is in 1mm increments

Order No.	Description	List Price	Sale Price
52-380-100-0	6"/150mm Pocket Steel Rule	\$11.00	\$10.00

THE FUTURE OF INSPECTION

AUTOMATED ROBOTS + OPTICAL SCANNING

Let the robot handle repetitive inspections & free up resources for other tasks



Techman collaborative robot for picking parts

3D Camera identifies part from pick bin

Robot places part into inspection solution

Live data

Touchscreen controls allow for quick changes, monitoring, and running different inspection programs

Robot moves part from inspection solution to sort based on inspection classification

1 See

3D camera precisely identifies and locates your parts, even when they're randomly arranged in a bin

2 Pick

The robot arm intelligently picks a single part and transfers it with fluid precision to the Inspection Solution

3 Inspect

The part is placed into the Inspection Solution for a complete, non-contact inspection in about 30 seconds

4 Sort

The robot takes the part and places it into a "Pass," "Fail," or "Rework" bin based on the inspection results, providing actionable, error-free quality data



fowlerprecision.com/automation



WILLRICH PRECISION
I N S T R U M E N T
THINK MEASUREMENT... THINK WILLRICH

Ph 866-945-5742 email:sales@willrich.com

West Coast Service & Repair Center
485 Poinsettia Ave UNIT 115, Vista, CA 92081 (

Find us on social media

